

**SPALDING**  
ATHLETIC LIBRARY



3 1850 011 882 660

OFFICIAL GUIDE

# WRESTLING

REVISED RULES

1938-39

GV  
1195  
.0 4  
1927/28-  
1939/40

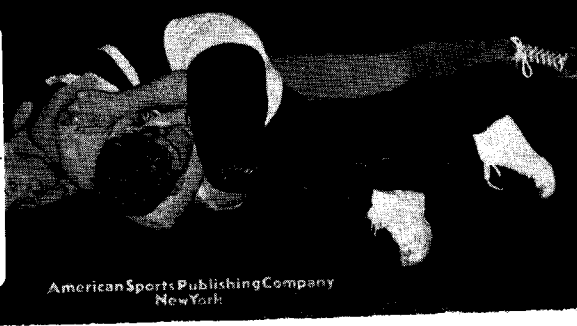

American Sports Publishing Company  
New York

# A RECORD that has never been equalled!

SPALDING is proud of the fact that it has not only kept pace with sport in America, but that it has made—and *continues* to make—material contributions to its development.

- Spalding has outfitted every U. S. Olympic Track and Field Team since the revival of the Olympic games in 1896.

- Spalding produced the first golf ball ever made in this country.

- Spalding produced the first golf clubs ever made in this country.

- Spalding originated matched and related golf clubs.

- Spalding produced the first tennis ball ever made in this country.

- The Spalding Tennis Ball has been adopted by the U. S. L. T. A. for use in the National Clay Court Championships for the past 26 years.

- The Spalding Official National League Baseball has been the one and only ball used by the National League for over 50 years.

- Spalding produced the first football ever made in this country.

- Every long pass recorded has been made with a Spalding Official Football.

- Every record kick has been made with a Spalding Official Football.

- Spalding produced the first basketball ever made in this country.



Printed in U.S.A.

J.W. Begala K.S.U.

SPALDING'S "RED COVER" SERIES OF  
ATHLETIC HANDBOOKS  
No. 429

## National Collegiate Athletic Association Wrestling Rules 1938-1939

*As Recommended by the Rules Committee  
consisting of*

DR. R. G. CLAPP, Chairman . . . University of Nebraska  
DR. J. A. ROCKWELL, Secretary . . . Mass. Inst. Tech.  
C. P. MILES . . . . . Virginia Polytechnic Institute  
E. G. SCHROEDER . . . . . State University of Iowa  
C. F. FOSTER . . . . . Princeton  
J. W. HANCOCK . . . Colorado State College of Education  
B. E. WIGGINS . . . Columbus (Ohio) Public Schools  
Representative of National High School Federation

### *Advisory Committee*

First District . . . . . R. K. COLE (Brown)  
Second District . . . W. AUSTIN BISHOP (Pennsylvania)  
Third District . . . LIEUT. COL. H. M. READ (Va. Mil. Inst.)  
Fourth District . . . HUGO OTOPALIK (Iowa State College)  
Fifth District . . . E. C. GALLAGHER (Okla. A. & M.)  
Sixth District . . . R. J. MCLEAN (Univ. of Texas)  
Seventh District . . . SHERMAN COUCH (Univ. of Utah)  
Eighth District . . . HENRY STONE (Univ. of California)

OFFICIAL PUBLICATION  
Edited by DR. R. G. CLAPP

PUBLISHED BY  
AMERICAN SPORTS PUBLISHING CO.  
NEW YORK

# Contents

	PAGE
Changes in Rules	5
Rules for Wrestling	7
High School Wrestling Rules	39
Index to Rules	43
Basis for Decisions	44
Questions and Answers	45
Instructions to Referees and Suggestions to Coaches	49
Medical Suggestions for Protective and Preventive Measures	51
Impetigo	51
Watch the Ears Carefully	53
Dehydration	54
Attention to Details Will Ensure Safety	55
Popularizing Wrestling in School and College	57
Training Wrestling Officials	60
Coaches and Contestants—Attention	61
N.C.A.A. Championships	63
Western Conference (Big Ten)	66
Missouri Valley I.C.A.A. (Big Six) Conference	69
Intercollegiate Wrestling in Oklahoma	69
Eastern Intercollegiate Championships	72
Southern Conference	77
Intercollegiate Wrestling in the Rocky Mountain Region	79
Mountain States Athletic Conference	81
Intercollegiate Wrestling on Pacific Coast	83
Wrestling in California Junior Colleges	85
"Little Three" Championships	87
Intercollegiate Wrestling in Ohio	88
Scores of Dual Meets	93
American Amateur Wrestling Coaches Association	118
Wrestling Officials	119

## INTERSCHOLASTIC WRESTLING.

Nationwide Notes on High School Wrestling	96
First Annual Ohio Interscholastic Championship Meet	98
Akron Area	99
Cleveland District	100
Chicago Public Schools	101
Illinois	101
Wisconsin	102
Iowa	103
Minnesota	104
Kansas	105
Nebraska	106
Oklahoma	106
Colorado	107
Washington	108
Oregon	109
Southern California	110
Long Island, New York	112
Northern New York	112
Western Pennsylvania	113
North Carolina	114

Copyright, 1938  
by the  
National Collegiate Athletic Association.

## Changes in Rules

### COLLEGE RULES.

Important changes designated by a ★

The attention of contestants and coaches is called to the following changes:

**RULE 1.**

New Eligibility Rules for National Collegiate wrestling championships.

**RULE 3, Section 1.**

Canton flannel cover for wrestling mat recommended. Arrow at center of cover (or mat when cover not used) required.

**RULE 3, Section 2.**

Strongly recommended that when protective covering for ears is necessary, cotton, gauze and adhesive bandages be used instead of headgear.

**RULE 3, Section 3.**

When necessary, home management to provide some means of distinguishing contestants.

★**RULE 4, Section 1.**

Three lower weights in COLLEGE COMPETITION changed to 121, 128, and 136 pounds.

★**RULE 5, Section 3, "Note," and Section 4.**

Weight reduction and medical supervision.

★**RULE 6, Section 2, "Note," (Byes).**

★**RULE 7 (NEW RULE), Section 1.**

Position of advantage secured at edge of mat.

★**RULE 7, Section 2.**

Referee to indicate when a contestant secures or loses advantage.

★**RULE 8, Section 2.**

All holds which "endanger life or limb" are illegal and Referee is instructed to stop promptly all such holds, even if they are holds not classed as Illegal Holds.

★**RULE 8, Section 3.**

Addition to rule, regarding Referee's Position on the Mat.

★**RULE 8, Section 4.**

Contestants are expected to wrestle near center of mat.

★**RULE 11, Section 1, A and B; Section 2, B and C; Section 3.**

Increased Penalties for infringement on rules. Study carefully.

★**RULE 12, Section 1.**

New rule, regarding time out in case of injury.

★**RULE 14, Section 2, A.**

Legal fall may now be called with HEAD off mat proper.

★**RULE 15, Section 3, A.**

Basis of decision changed when match goes to extra-period bouts.

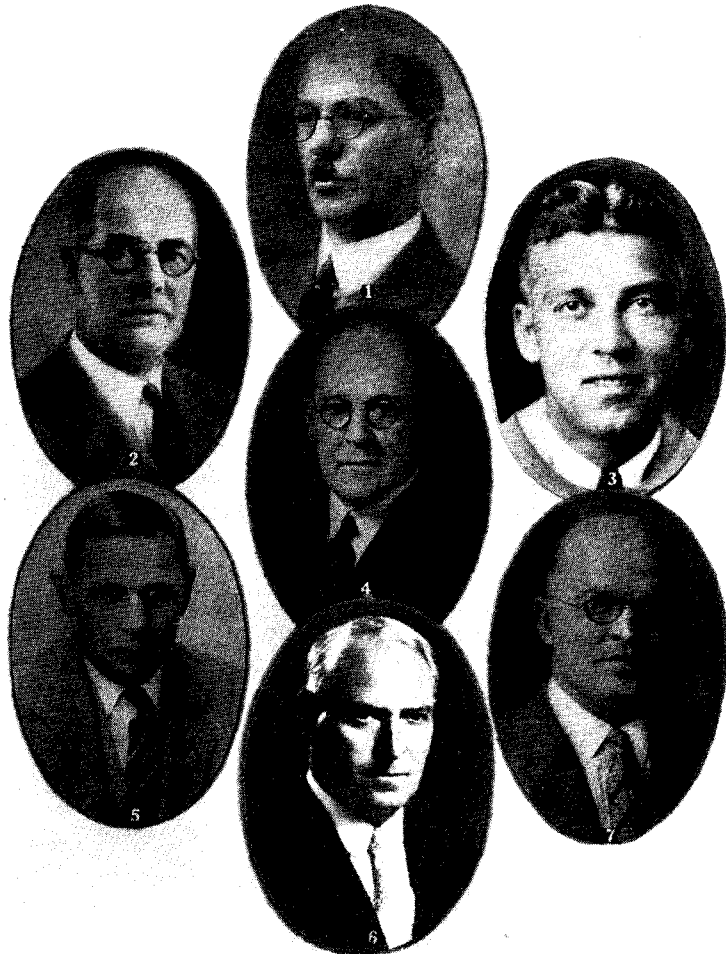

1. Dr. R. G. Clapp, University of Nebraska, Editor; 2. Dr. J. A. Rockwell, Massachusetts Institute of Technology; 3. John W. Hancock, Colorado College of Education; 4. B. E. Wiggins, Columbus (Ohio) Public Schools; 5. C. P. Miles, Virginia Polytechnic Institute; 6. C. F. Foster, Princeton; 7. E. G. Schroeder, University of Iowa.

WRESTLING RULES COMMITTEE OF THE NATIONAL COLLEGIATE ATHLETIC ASSOCIATION.

★**RULE 16, Section 1, B.**

New rule, regarding points to be scored in championship meets when only one, two, or three contestants enter and qualify for a weight class.

**IMPORTANT**—Read carefully article on "Basis for Decisions" on page 44.

A considerable number of changes have been made in the Wrestling Rules for 1938-39. Some of these changes are quite radical. The Committee hopes that they will result in more active, aggressive wrestling and in increased, general interest in the sport.

Many changes recommended by the coaches have not been incorporated in the new rules. Many of these recommendations have merit and will be given further careful consideration and may be approved at a later date. The hearty co-operation of all the wrestling coaches in giving the new rules a thorough and fair trial will be greatly appreciated by the Wrestling Rules Committee.

**HIGH SCHOOL RULES**

The Wrestling Rules Committee has decided to make no changes in the High School Rules for the season of 1938-39.

Several changes recommended by the Oklahoma Wrestling Coaches Association were given careful consideration by the Rules Committee. Two of these recommended changes were the barring of all "scissors" and "the twisting knee-lock escape." These recommendations were made to prevent injury to high school wrestlers. The Committee is in entire sympathy with the aim of the Oklahoma Wrestling Coaches Association, but the Committee is of the opinion that the present rules will safeguard the contestants if the officials will properly apply the present rules.

The attention of all coaches and contestants is called to Rule 8, Section 2 and particularly to the new "Note" under this Section 2. All should bear in mind the fact that many holds in wrestling which are commonly considered legitimate holds may be used in such a vicious manner as to endanger life or limb. Most coaches and contestants clearly understand the difference between legitimate and illegitimate use of these holds. If the Referee cannot stop a hold which is being used in a vicious manner before injury results to the opponent, his duty is clear. If the injury is so serious that the opponent is unable to continue the match, the Referee should disqualify the offender and award the match to the injured wrestler. The prompt enforcement of the above penalty by Referees will quickly discourage illegitimate use of holds and encourage the proper use of these holds.

R. G. CLAPP, M.D.,

Chairman, National Collegiate Wrestling Rules Committee.

# Rules for Wrestling

Copyright, 1938, by the National Collegiate Athletic Association.

*Wrestling Committee:*

DR. R. G. CLAPP, University of Nebraska, Chairman; DR. JOHN A. ROCKWELL, Massachusetts Institute of Technology, Secretary; C. P. MILES, Virginia Polytechnic Institute; B. E. WIGGINS, Columbus (Ohio) Public Schools; E. G. SCHROEDER, State University of Iowa; C. F. FOSTER, Princeton University; J. W. HANCOCK, Colorado State College of Education.

*Advisory Committee:*

RICHARD K. COLE, Brown University, First District; W. AUSTIN BISHOP, University of Pennsylvania, Second District; LIEUT. COL. H. M. READ, Virginia Military Institute, Third District; HUGO OPOPALEK, Iowa State College, Fifth District; E. C. GALLAGHER, Oklahoma A&M College, Fifth District; R. J. McLEAN, University of Texas, Sixth District; SHERMAN COUCH, University of Utah, Seventh District; HENRY STONE, University of California, Eighth District.

Particular attention is called to Notice on page 61, entitled, "Coaches and Contestants—Attention."

*Alterations and additions to rules indicated by a check mark. ✓*

## Rule 1. Eligibility

1. Each contestant must be an Amateur as defined in the rules of the National Collegiate Athletic Association and be eligible according to the rules and regulations of the college or university which he represents.

2. In addition to the above, participants in the National Collegiate Athletic Association championship meet must represent institutions which are active individual or allied members of the National Collegiate Athletic Association and must conform to the rules of eligibility adopted by the N.C.A.A., to apply to all annual championship meets conducted by this Association. These rules will be printed and explained in the entry blanks for the National Collegiate Wrestling championship meet.

3. Hereafter, all colleges, universities, and institutions of learning in the United States with acceptable scholastic and athletic standards may become active members of the National Collegiate Athletic Association at any time upon approval of the President, Secretary, and Vice-President of the National Collegiate District in which that institution is located. Hereafter, representatives of institutions which are included in the Allied Membership of the N.C.A.A.

**RULE 1, Section 3**

may participate, provided the representatives' institution pays into the N.C.A.A. treasury a fee of \$10.00. In addition to the above, the usual individual entry fee of \$2.00 is charged by the National Collegiate Wrestling Rules Committee.

*Note.* See Rule 5, Section 4.

**Rule 2. Representation**

1. An institution shall be represented by only one contestant in each class, but two or more names may be submitted in advance of the date set for the meet.

2. No contestant shall be allowed to compete in more than one class in each meet.

*Note.* See Rule 5, Section 1D (a), (b), (c).

**Rule 3. Mats, Ropes and Costumes**

1. The area of the mat shall not be less than 20 feet by 20 feet and this dimension shall be considered the standard size, when ropes are used. When ropes are not used a 24-foot by 24-foot mat shall be considered standard. The "roped in" area, when used, shall conform with the following specifications:

Three 1-inch ropes shall be tightly stretched 2 feet, 3 feet and 4 feet, respectively, above the mat. These ropes shall extend in from four supporting posts, which shall be placed at least 18 inches back from the corners of the ring. Cotton ropes are recommended, but if manila or sisal ropes are used they must be wrapped with bunting or other soft material to avoid "rope burns." To prevent the spreading of ropes during bouts, they shall be securely fastened together by twelve vertical  $\frac{3}{8}$ -inch ropes, three of which shall be placed equidistant on each side of the ring.

Raised platforms are not recommended and should not be used without ropes. Even when used with ropes the platform should extend at least 6 feet beyond the ropes on all sides of the ring.

It is recommended for competition and for practice that the wrestling mat be covered with a Canton flannel cover sufficiently large to fold under mat. This cover should be stretched tight and may be held in place by horse blanket safety pins fastening the cover to the under side of the mat.

There shall be placed at center of the cover (or on mat when cover is not used) an arrow head 12 inches long,

**RULE 3, Section 1**

placed perpendicularly to and pointing away from the Timers' table and not pointing toward either team. This arrow designates the place where bouts are to start and the direction the wrestlers are to face when starting the wrestling from the "Referee's Position on the Mat."

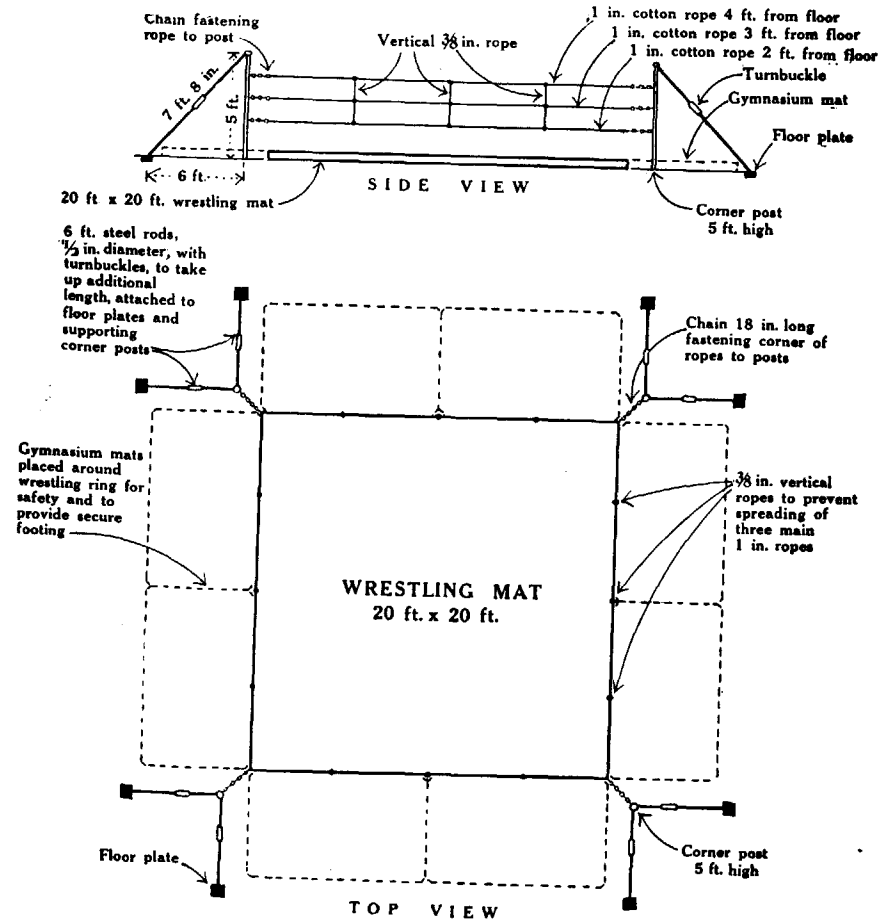

## RULE 3



No. 1—LEGAL "REFEREE'S POSITION ON MAT."

This position is shown as required in Rule 8, Section 3. Note particularly that offensive wrestler's right leg is outside of defensive wrestler's left leg.

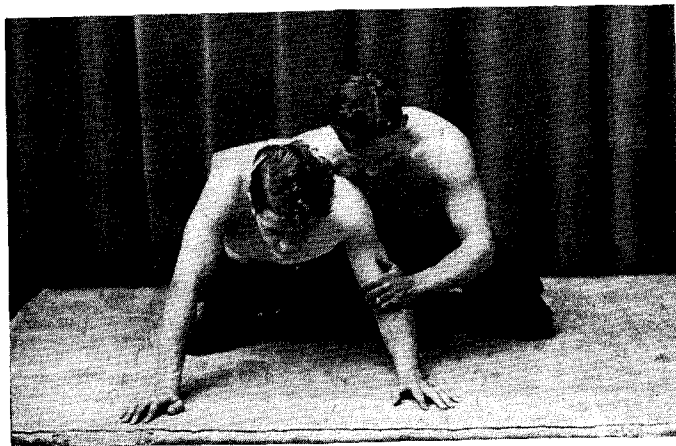

No. 2—ILLEGAL "REFEREE'S POSITION ON MAT."

This position is illegal because offensive wrestler's right knee is inside of defensive wrestler's left leg.

2. The uniform shall consist of full length tights, an outside wrestling supporter or close fitting outside short trunks, light heel-less gymnasium shoes laced by means of eyelets, and shirts, if they are required in accordance with the following provision: The home institution shall decide whether shirts shall or shall not be worn; however, the visiting team or teams shall not be required to wear shirts unless they are so notified by the home management at least ten days before the meet. If shirts are worn, they shall be sleeveless; there shall be no fasteners of any sort on the shoulders, and they shall be fastened down at the crotch. (The shirt recommended is the "V" type, fastened underneath the crotch by small hooks and eyes.)

When protective covering for the ears is necessary, the Wrestling Rules Committee strongly recommends that cotton, gauze and adhesive bandages be used, and not head-gears.

3. It happens occasionally that two contestants look so much alike and are dressed so similarly that it is very difficult for the Referee and spectators to distinguish them. In all dual or championship meets, the home management should have immediately available some provision for clearly identifying the contestants. Such provision may be by means of colored anklets (as heretofore recommended), numbers, or any other plan which will accomplish the purpose.

### Rule 4. Weight Classification

1. Competition shall be divided into eight weight classes as follows:

121 lbs. and under.	155 lbs. and under.
128 lbs. and under.	165 lbs. and under.
136 lbs. and under.	175 lbs. and under.
145 lbs. and under.	Unlimited Heavyweight.

### Rule 5. Weighing-in of Contestants

#### 1. Time

A. In Championship Meets. Contestants may weigh-in a maximum of five hours and a minimum of three hours before time meet is scheduled to begin.

B. In Dual Meets. Contestants may weigh-in a maximum of five hours and a minimum of one-half hour before

**RULE 5, Section 1B**

time meet is scheduled to begin. The exact maximum time shall be decided by mutual agreement of the competing teams.

**C. Supervision.** The Referee or other authorized person shall supervise the weighing-in of contestants.

**D. (a)** In championship or dual meets, a team is privileged to weigh-in two contestants only, in any weight class, but only such contestants as have properly weighed-in for that weight-class shall be allowed to compete.

**(b)** In championship meets the contestant who is to represent his institution must be named before the drawings are made.

**(c)** In dual meets the home team's representative shall be sent onto the mat first, and he cannot be withdrawn or replaced.

### 2. Weight Allowance

**In Dual and Championship Meets.** In all dual and championship meets net weights shall be required, except that on the second day and succeeding days in championship meets, one pound overweight shall be allowed.

### 3. Failure to Make Weight

Any contestant failing to make weight at the maximum time mutually agreed upon, shall be allowed until the minimum time to make weight (See Rule 5, 1-A and 1-B). Contestants who then fail to make the required weight shall be rejected.

*Note.* Excessive weight reduction has hurt, and is still hurting, some contestants and our sport in general. The National Collegiate Wrestling Rules Committee urges all Directors of Athletics to use their influence against excessive weight reduction by members of their wrestling teams and to put the entire control of weight reduction to be allowed in the hands of the College Physician. It is further recommended that the College Physician personally weigh all candidates for the team at the beginning of the training season and that the Wrestling Coach shall be required to furnish the College Physician during the regular training season daily records of the weights of all candidates for the team taken at the beginning and at the end of each practice period, and that no wrestler shall be allowed to participate in any contest without the approval of the College Physician.



**No. 3—ILLEGAL USE OF HANDS IN BODYLOCK WHILE DEFENSIVE CONTESTANT HAS BOTH KNEES ON MAT.**

Offensive wrestler is not allowed to lock hands, wrists or arms around body while defensive wrestler has both knees on mat. (See Rule 8, Section 1.)

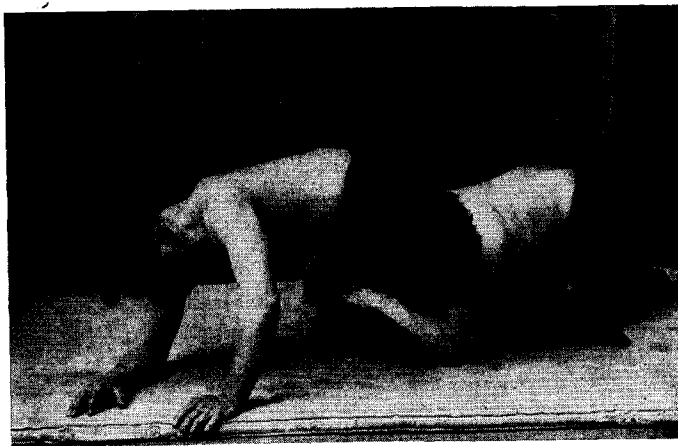

**No. 4—ILLEGAL USE OF HANDS IN LEGLOCK ON MAT.**

The position is illegal because of Rule 8, Section 1, which forbids interlocking of fingers, hands or arms around body or legs while contestants are on mat.





No. 5—LEGAL USE OF HANDS IN BODYLOCK.

This complete bodylock is legal because defensive wrestler is in a sitting position. This hold would be illegal if defensive wrestler had both knees on mat. (See Rule 8, Section 1, Note 3.)

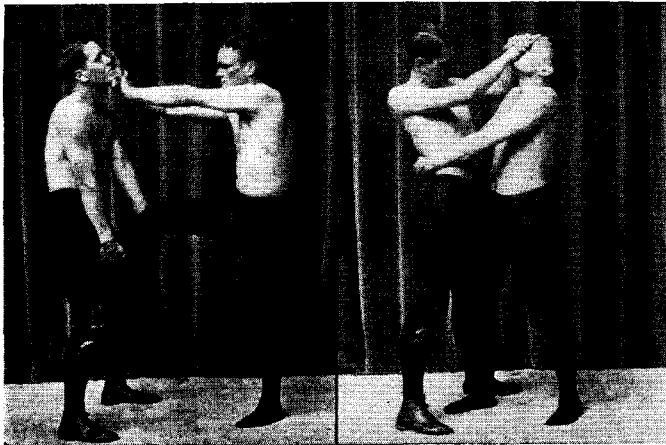

No. 6—LEGAL BLOCKING ON FACE (ON CHIN).

Blocking on chin or forehead is legal, but is not legal over face proper; that is, over mouth, nose or eyes.

No. 7—ILLEGAL BLOCKING ON FACE (ON FACE PROPER).

This form of blocking is illegal because it is over mouth, nose and eyes, in contrast to position in No. 6.

#### 4. Communicable Disease to Disqualify

RULE 5

At the time of the weighing-in on the opening day of the annual National Collegiate Championships, a physician or physicians shall be present to examine all contestants for communicable diseases and shall have power to disqualify any contestant who, in their judgment, will endanger other participants. In other meets it is recommended that a medical examination of all contestants be made at the time of the weighing-in, and the presence of a communicable disease or any other condition which in the opinion of the examining physician makes the participation of that individual inadvisable, should be considered full and sufficient reason for disqualification.

### Rule 6. Drawings and Eliminations in Championship Meets

1. In all championship meets drawings shall be made in accordance with the regular Bagnall-Wild System, except as provided in Section 2 of this rule.

2. **Seeding.** Whenever there are two outstanding contestants in any class, in order to prevent them from meeting in the early rounds whereby one of them would of necessity be eliminated, the name of one of these contestants shall be placed in the upper half of the drawing bracket and the name of the other shall be placed in the lower half of the bracket.

In the annual National Collegiate championship meet, whenever possible, contestants from the same geographical location or conference, who have previously met in dual or other competition, shall be so seeded as to prevent them from meeting in the early rounds.

*Note.* Seeded contestants may be given any number in their own half of the bracket, but a number which represents a bye shall only be given when that appears to be the fairest plan for the majority in that bracket.

#### Method of Drawing in Bagnall-Wild System.

3. **Drawings for First Place.** Immediately after the expiration of the minimum weighing-in time, drawings shall be made for each class, starting with the 121-lb.

**RULE 6, Section 3**

class, and progressing in order up to the heavyweight class as follows:

Each contestant (except "seeded" contestants) shall draw a number and shall compete in accordance with the diagram shown in Section 5 of this rule.

*Note.* Before drawings for each class begin, the numbers opposite the byes and also the numbers assigned to seeded contestants must be taken out.

4. **Byes.** When the number of competitors is not a power of two (that is, 4, 8, 16, 32, 64) there shall be "byes" in the first round. The number of pairs which meet in the first round shall be equal to the difference between the number of competitors and the next lower power of two. The byes, if even in number, shall be equally divided between top and bottom. If the number of byes be uneven, there shall be one more bye at the bottom than at the top, as shown in Section 5 of this rule.

**5. Graphic Illustration of Drawings by Bagnall-Wild System.**

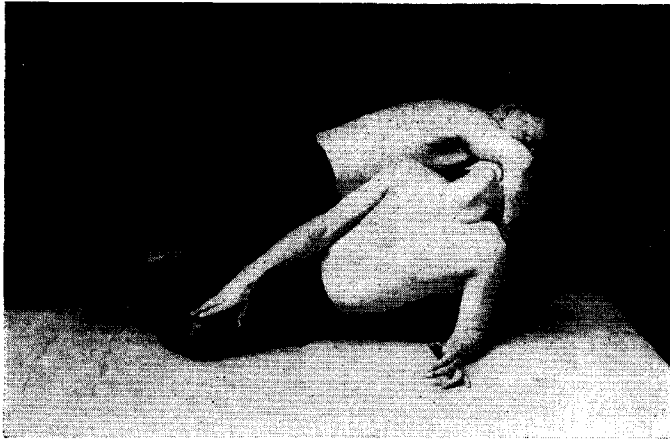
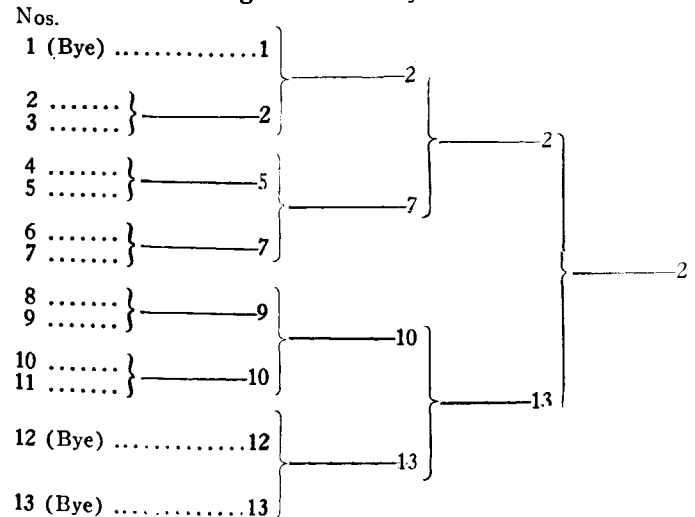

No. 8—ILLEGAL FACE HOLD.

Shows a hold commonly used but which is contrary to both the letter and spirit of amateur wrestling rules. It is frequently used momentarily in order to prevent defensive wrestler from coming out from underneath or to bring defensive wrestler back into position for a fall. Referee should see that offensive wrestler does not secure unfair advantage by means of this illegal hold.

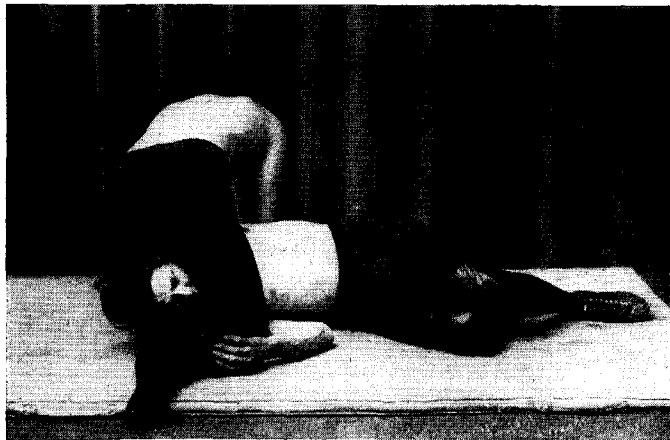

No. 9—LEGAL HEAD-SCISSORS.

The head-scissors is considered legal when taken as shown above, with the hold on either side of the face, even though the bend of the knee may be in front of the nose, mouth or eyes; provided the leg is not in close contact as to interfere with the breathing of the defensive wrestler. If defensive wrestler strangles himself by refusing to let his body turn as head is twisted by the head-scissors, the hold is still legal.

**RULE 6, Section 5**

The foregoing illustration of method of drawings and participation of contestants by the Bagnall-Wild System shows drawings with thirteen contestants. Competitors draw Nos. 1, 12, and 13 draw byes and go into the second round without wrestling. Except as just stated, the numbers carried forward to next frame indicate the winners of these bouts. This illustration shows No. 2 as the winner of the championship.

*Note.* No further drawing is necessary for later rounds, and there will be no byes after the first round.

**6. Contestants Eligible for Second Place Matches.**

A. In each weight, the defeated contender in the final championship match shall wrestle for second place against the winner of elimination bouts between those contestants who were defeated by the champion prior to the final championship match. The winner of this final second place match shall be awarded second place.

B. When only two contestants have been defeated by the winner of first place prior to the final championship match, the two defeated contestants shall compete in a preliminary second place round and the winner of the bout shall meet the defeated finalist to decide the second place winner. When more than two contestants have been defeated by the winner of first place prior to the final championship match, preliminary matches will be necessary and should be conducted *in accordance with the original first round drawings*. Those contestants eligible are designated in Section 6A of this Rule. Referring to the "Graphic Illustration" under Section 5, those eligible for the preliminary second place round are Nos. 1, 3, and 7. We will assume that No. 1 wins from No. 3 and that No. 7 then defeats No. 1. No. 7 thus earns the right to meet in the final second place match the defeated finalist of the first place round (No. 13). We will assume that No. 13 wins this match and second place honors.

*Note.* The defeated finalist is the loser in the final first place championship match.

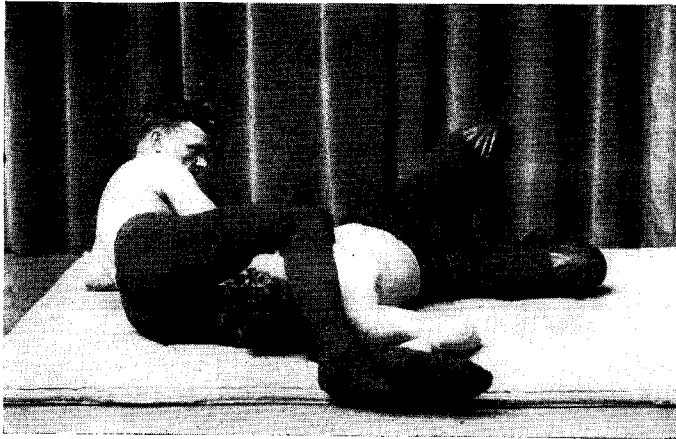

No. 10—ILLEGAL HEAD-SCISSORS.

This hold is illegal because the pressure is over the front of the face, in contrast to pressure on the sides of the face as shown in No. 9.

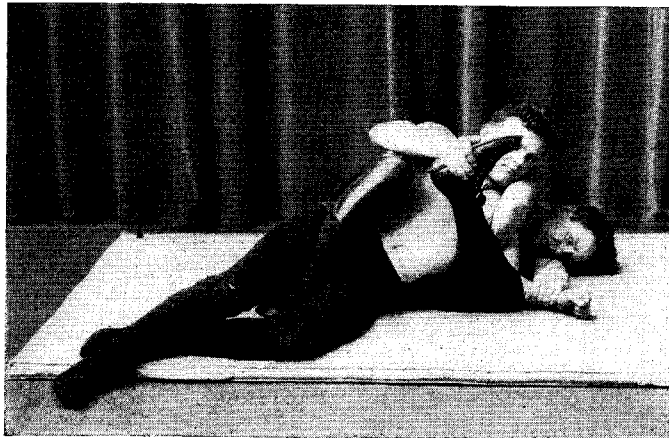

No. 11—LEGAL FOOT (INSTEP) HOLD.

The defensive wrestler is allowed to grasp instep, heel or ankle to break such holds as body-scissors, leg-ride, etc.; provided the foot is not drawn up to the point where, in the opinion of the Referee, it endangers knee or hip-joint.

## RULE 6

## 7. Contestants Eligible for Preliminary Third Place Matches.

A. In case the defeated finalist is also defeated in the final second place match, he is automatically awarded third place and no third place round shall be wrestled.

B. A third place round shall be contested only when the winner of second place is the defeated finalist. (See Section 7A.) When a third place round is necessary, it shall be conducted as follows: In each weight the defeated contender in the final second place match shall meet, to decide third place, the winner of elimination bouts between those contestants who have been defeated by the winner of second place prior to the final second place match.

C. When more than two contestants have been defeated by the winner of second place prior to the final second place match, third place preliminary matches will be necessary and should be conducted *in accordance with the original first place drawings*. (See Section 6B.) Referring again to the "Graphic Illustration" under Section 5, those eligible to compete in the preliminary third place round are those who have been defeated by No. 13 prior to the final second place match, *i.e.*, Nos. 10 and 12. Let us assume that No. 12 wins this match. He will meet for third place honors, No. 7, the defeated contender in the final second place match. Had No. 7 defeated No. 13 in the final second place match, No. 13 would have been automatically awarded third place because he was the defeated finalist for the class championship.

**Rule 7. Position of Advantage***(New Rule)*

1. Whenever a contestant brings his opponent to the mat while the supporting points of his own body are on the wrestling mat proper, he has earned the Position of Advantage, even though the defensive wrestler's body is entirely outside of the mat proper; and the offensive wrestler is entitled to this advantage until such time as his opponent, in legal manner, gains a neutral position or reverses position (secures the Position of Advantage) *within the boundary of the mat proper*, except when he forfeits this advantage

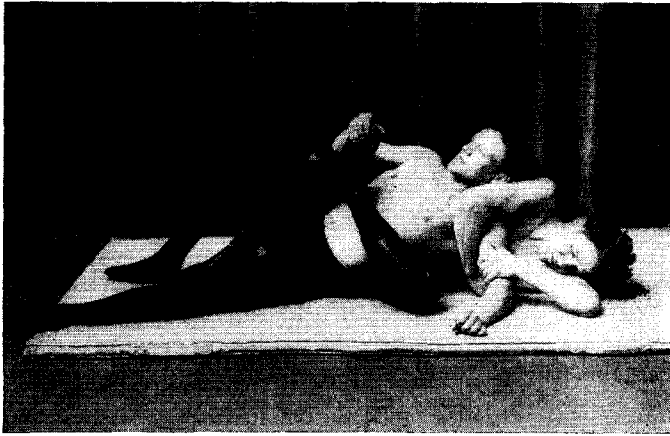

No. 12—ILLEGAL TOEHOLD.

All toeholds, regardless of the degree to which the leg is twisted, are illegal under these rules.

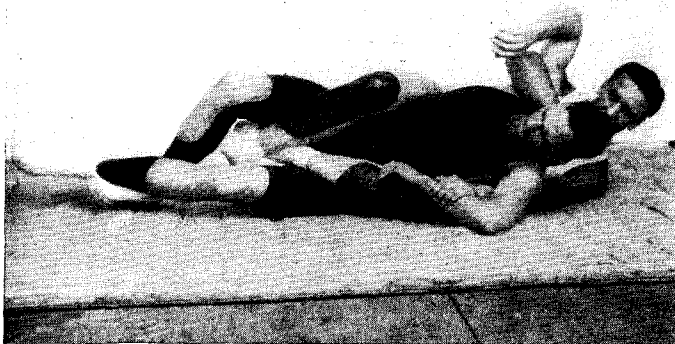

No. 13—OVER-SCISSORS (AN ILLEGAL HOLD).

The over-scissors is barred entirely under these rules because it is only a punishing hold and is of no value unless defensive contestant who uses it is allowed to force the hold, which thereby endangers the ankle and knee of his opponent.

## RULE 7, Section 1

by reason of penalty inflicted by the Referee for infringement of the rules. (See Rule 9, Section 1, B and C.) To avoid injury to contestants, the wrestling mat proper shall be surrounded *on all sides* by supplementary mats 5 feet in width. *Note.* The "out-of-bounds" rule applies also when one contestant has had the Position of Advantage on the mat immediately before leaving the mat.

2. The Referee shall indicate orally, and by pointing in such a manner that all present may know, whenever a contestant has earned the Position of Advantage, and he shall also indicate in similar manner during the progress of the bout which opponent has the advantage whenever he thinks there may be doubt in the minds of the contestants, coaches, or spectators as to which contestant has the Position of Advantage. The Referee shall also indicate in a manner clear to all present whenever the match reverts to a "No Advantage" status. For the sake of uniformity, it is recommended that all Referees indicate the advantage by calling in loud, clear tone, "So-and-So's Advantage" (naming the institution represented by the contestant who has earned the advantage) and at the same time pointing to this contestant. When the neutral aspect is resumed, the Referee should indicate this by extending both arms sideways (with forearms and hands at about the level of the waist) and palms of hands down.

### Rule 8. Legal and Illegal Holds and Positions

1. **Illegal Holds.** Any hold, lock or grip shall be allowed except the hammerlock above the right angle, twisting hammerlock, over-scissors, strangle holds, full (double) nelson, toe holds, certain body slams (See Note 6), holds over mouth, nose or eyes (*i.e.*, over front of face), interlocking of fingers, hands or arms around body or legs while contestants are on the mat, bending or twisting of fingers for punishment or to break holds, or any hold used for punishment alone.

*Note 1.* Attention is called to the fact that if the double wristlock is brought up into a twisting hammerlock, it becomes an illegal hold and must be stopped by the Referee and treated as any other illegal hold, and no contestant shall

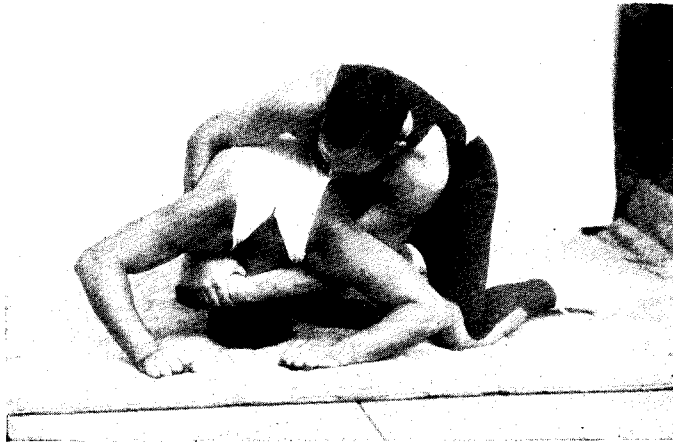

No. 14—FULL NELSON.

This hold needs no explanation. Most of the difficulty has arisen when the three-quarter nelson is confused with the full nelson. In the full nelson the aggressor places both arms under his opponent's arms and clasps his hands or wrists on the back of his opponent's head. This is dangerous and is barred.

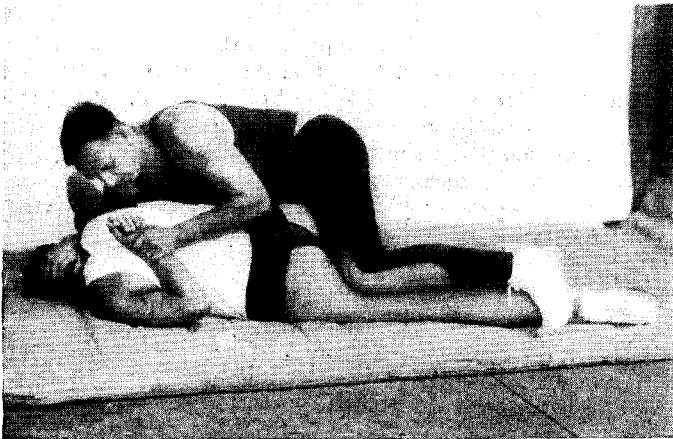

No. 15—ILLEGAL HAMMERLOCK (ABOUT RIGHT ANGLE).

The hammerlock is a legal hold, provided the arm is not bent above the right angle (*i.e.*, provided that the arm is not carried above the small of the back); and provided, further, that the hand is not forced out away from the body, making it a *twisting* hammerlock. In this illustration the arm is carried distinctly above the right angle and is dangerous.

## RULE 8, Section 1

be allowed to retain any advantage he secures by use of the wristlock in this illegal way. The Referee is further instructed that he should anticipate danger of injury from this hold and stand so that he may block the double wristlock before it reaches the danger point.

*Note 2.* The Committee calls the attention of the coaches and contestants to the fact that injuries are sometimes caused by a lack of knowledge on the part of contestants of such holds as the double wristlock (which may cause injury when used legally), the keylock and other more or less dangerous holds. Contestants should have a knowledge of the dangers of these holds and a knowledge of the blocks for them.

*Note 3.* In the interpretation of the clause "interlocking of fingers, hands or arms around body or legs while contestants are on the mat," in Section 1 of this rule, this restriction does not apply when the defensive man has regained his feet, when he is in a sitting position on the mat or when he has only one knee on the mat. Lifting of one or both hands from the mat does not affect this rule and, therefore, no complete armlock is permitted until one knee is raised from the mat.

*Note 4.* Contestants may grasp all four fingers in an effort to break a hold, but pulling back the thumb or one, two or three fingers is illegal.

*Note 5.* See photographs and explanations of legal and illegal holds.

*Note 6.* A body slam is illegal unless the attacker brings one of his knees to the mat before the upper part of his opponent's body touches the mat. The term "slam" refers to the lifting of an opponent off his feet and slamming him to the mat.

## 2. Unnecessary Roughness. No striking, kicking, gouging, hair pulling, butting, elbowing, strangling, or anything that endangers life or limb shall be allowed.

*Note.* In the application of the latter part of the above rule, all Referees, Coaches and contestants should understand that any and all holds used in such a way as to endanger life or limb are illegal and all Referees should be on the alert to stop if possible all holds that in their opinion are likely to result in endangering of life or limb before real injury does occur. It should also be understood that no contestant should ever be put in a position where he must forfeit a neutral position, a position of advantage or a fall because of danger to life or limb, and the Referee should promptly stop any and all holds which in his opinion may so result. (See Rule 8, Section 1, Notes 1 and 2.)

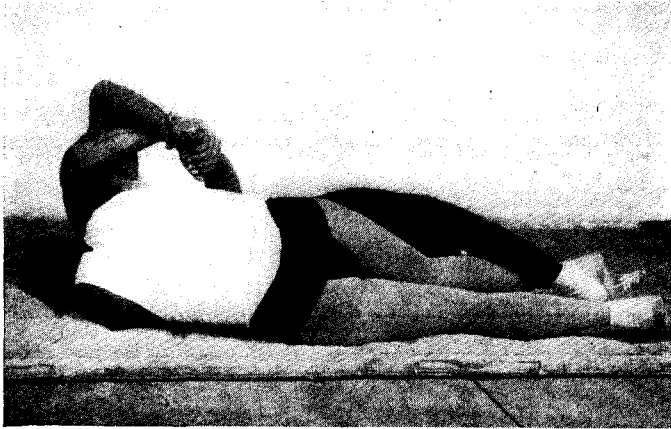

No. 16—LEGAL DOUBLE WRISTLOCK.

The double wristlock, as shown above is legal so long as the arm is not carried back into a twisting hammerlock, and provided the body or legs are not so locked as to prevent the opponent's body from turning. The hooking of the toe over opponent's near ankle is commonly used to prevent opponent from swinging around to the front, and if held loosely does not prevent opponent's body from turning; but it must be released before opponent can be brought onto his back.

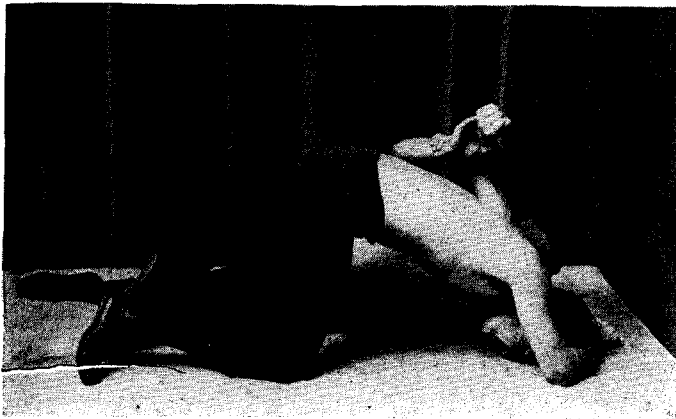

No. 17—ILLEGAL DOUBLE WRISTLOCK.

This cut shows double wristlock turned into a typical twisting hammerlock that will injure opponent's shoulder if the arms are forced upward, unless opponent turns with the pressure, which often he is unable to do promptly enough to prevent injury to the shoulder.

**RULE 8**

3. **Referee's Position on the Mat.** The defensive contestant *must face in the direction indicated by the arrow at the center of the mat.* He must place both knees on the mat, with the lower legs parallel, and he must place the heels of both hands on the mat not less than 12 inches in front of the knees. The offensive wrestler shall be slightly over opponent at his left (or right) side with his right (or left) arm resting *loosely* around opponent's waist and his left (or right) hand *loosely* on opponent's left (or right) elbow. Both of his knees shall be on the mat and outside of defensive wrestler's near leg.

*Note 1.* See cuts on pages 10, 12 and 14.

*Note 2.* Occasionally a Referee has been guilty of standing so close to contestants as he starts a bout from the "Referee's Position on the Mat" that one or the other of the contestants has been handicapped in his legitimate activity. It is recommended that the Referee take a position directly in front of contestants and facing them, and that before he calls "wrestle" he shall move back far enough so that neither contestant can possibly be handicapped by his presence on the mat.

4. Contestants are expected to wrestle near the center of the mat, whether on the feet or in the "Referee's Position on the Mat." (Penalties for infringement of this Rule will be found under Rule 11, Section 2C.)

### **Rule 9. Bringing Contestants Back To Mat After Going Outside**

1. When the contestants are interlocked off or on the edge of the mat, time shall be taken out and contestants shall be brought to the center of the mat. The position to be assumed by contestants on resumption of match shall be determined as follows:

A. If neither contestant held a position of advantage immediately before leaving the mat, the bout shall be resumed with contestants on their feet in neutral position, except when Referee applies penalty indicated in Rule 11, Section 2A.

B. If a contestant held a position of advantage immediately before leaving the mat, on resumption of the match

**RULE 9, Section 1B**

this contestant shall be given the position of advantage in the "Referee's Position on the Mat" (see Rule 8, Section 3, and Rule 9), except when Referee applies penalties indicated in Rule 11, Sections 2B, 3 and 4, or in clause C (of Rule 9) following.

C. In case a fall is imminent and the man underneath intentionally leaves the mat, the Referee shall give contestants as nearly as possible the same position which they held when the bout was stopped. (See Rule 11, Section 4.)

### **Rule 10. Stalling**

1. **Stalling is Illegal Under These Rules.** While on their feet, contestants must wrestle; *i.e.*, they must make an honest effort to secure a position of advantage, regardless of any advantage previously obtained, and when one contestant has secured a position of advantage, whether on the feet or on the mat, he shall make an honest effort to secure a fall; furthermore, a contestant who has previously secured a considerable advantage over his opponent is stalling if he fails to make an honest effort to wrestle aggressively thereafter. (For Penalties, see Rule 11.)

2. Running or sliding off mat or going over or through ropes to prevent an opponent from going behind is to be interpreted as stalling. (For Penalty, see Rule 11, Section 2.)

*Note.* Referees are expected to enforce the foregoing rules on stalling.

### **Rule 11. Penalties**

1. **Stalling.**

A. If, in the opinion of the Referee, a contestant in a position of advantage on the mat, is stalling, the Referee may order the men to their feet in the neutral position, or he may warn the offending contestant once, after which he SHALL order the men to their feet in the neutral position.

After a contestant has been penalized once for the above infringement, the penalty for subsequent infringements in the same match shall be reversal of position in the "Referee's Position on the Mat," and for repeated infringements the Referee may, after one more warning, disqualify the offender.

**RULE 11. Section 1**

B. If, in the opinion of the Referee, a contestant in the neutral position on the feet, is stalling, the Referee may put the contestants in the "Referee's Position on the Mat," with the offender underneath, or he may warn the offending contestant once, after which he SHALL put the contestants in the "Referee's Position on the Mat," with the offender underneath.

✓ For repeated infringements on the above rule, the Referee may, after one more warning, disqualify the offender.

*Note.* For definition of "stalling" see Rule 10, Sections 1 and 2.

**2. Intentionally Going Off Mat.**

A. If, in the opinion of the Referee, a contestant intentionally runs, slides, crawls or rolls off the mat to prevent his opponent from going behind him, the Referee SHALL give his opponent the "Referee's Position Behind." (See Rule 8, Section 3.)

✓ B. In case a contestant repeatedly infringes on Rule 11, Section 2A, or intentionally and repeatedly goes off the mat while in the defensive position on the mat, the Referee may award a fall to his opponent after *one* warning has been given to the offending wrestler.

✓ C. If a contestant persists in taking a position near the edge of the mat for the purpose of going off the mat or of allowing his opponent to push him off the mat, when the opponent makes an effort to go behind him, the contestants shall be brought back to the center of the mat and the offender warned. Should he go off the mat as indicated above after such warning, he shall be placed in the defensive position in the "Referee's Position on the Mat." For further violations of this rule the same penalty shall be inflicted, but for repeated violations, the Referee may, after *one* further warning, disqualify the offender.

**3. Intentionally Pushing Defensive Wrestler Off Mat.** If, in the opinion of the Referee, a contestant intentionally pushes his opponent off the mat to keep him from getting clear or from going behind, the Referee ✓ SHALL bring both men to their feet at the center of the mat if he believes this illegal action has simply prevented the

**RULE 11. Section 3**

defensive wrestler from getting free; but if he believes the defensive wrestler would have gone behind his opponent had the illegal action not occurred, he shall give the defensive wrestler the "Referee's Position Behind." For repeated infringements of this rule in the same match the Referee may, after one warning, disqualify the offender.

**4. Going Off Mat To Prevent Fall.** If, in the opinion of the Referee, the defensive wrestler intentionally crawls, or rolls off the mat, or tangles his legs or arms in the ropes to prevent a fall, the Referee SHALL give one warning, and if infringement is repeated, the Referee SHALL award a fall to his opponent. (See Rule 9, Section 1C.)

*Note.* Referees are expected to enforce the foregoing penalty.

5. For infringements on Rule 8, Sections 1 and 2, by the offensive wrestler, when injury does not result in application of penalty provided under Rule 12, Section 3, the penalty shall be loss of his position of advantage. If repeated infringements are made by the defensive wrestler, or occur when contestants are in neutral position on the feet, the Referee may award a fall to the offended wrestler.

6. **Sideline Coaching.** If, in the opinion of the Referee, Rule 17 is being infringed upon, the Referee shall stop the bout and shall give a warning in such a manner that all contestants, coaches and spectators present shall be aware of the same. If the offense is repeated, the Referee shall disqualify the representative of the offending side and the points awarded for a fall shall be scored for his opponent.

**Rule 12. Injuries and Defaults**

1. If a contestant is injured, the Referee shall allow a ✓ maximum of three minutes rest. There shall be no limit to the number of rest periods which may be taken in any match, but the total time out shall not exceed three minutes. If, at the expiration of the rest period, he is able to continue wrestling, the bout shall be resumed as if the contestants had gone out-of-bounds. (See Rule 9, Section 1.)



**RULE 12, Section 1**

If the injured contestant is unable to continue wrestling, the bout shall be awarded in accordance with Sections 2 and 3 of this Rule.

**V** *Note.* In the interpretation of this rule nosebleed is not an injury, and the number and length of rest periods to be allowed is at the discretion of the Referee.

2. **Accidental Injury.** If a contestant is accidentally injured and is unable to continue the bout, his opponent shall be awarded the match by fall.

3. **Injury from Illegal Hold.** If a contestant is so injured by an illegal hold that he is unable to continue, the bout shall be forfeited to the injured contestant and shall be scored as a fall.

4. **General Default.** If a contestant forfeits a match for reasons other than those mentioned in the foregoing, his opponent shall be awarded the full quota of points he could score by securing a fall.

5. Whenever a contestant defaults a match in any championship meet, he is thereby barred from further participation in that meet; however, this shall not make him ineligible for the third place award in case he is injured in a final first place match and is obliged to default.

## **Rule 13. Length of Bouts**

1. **Methods of Conducting and Length of All Dual Meet Bouts and First Place Bouts in Championship Meets.** All first place bouts in championship meets and all dual meet bouts shall be nine minutes in length unless a fall occurs. If no fall occurs and the Referee does not award the bout to either contestant at the expiration of this period, two extra-period bouts of two minutes each shall be wrestled.

If either contestant brings his opponent to the mat and secures a position of advantage within the first three minutes of wrestling, the bout shall become a continuous nine-minute bout. A fall in any part of this continuous nine-minute bout terminates the match.

**RULE 13, Section 1**

If neither contestant secures a fall or a position of advantage before the expiration of three minutes of wrestling, the Referee shall stop the bout and the remaining six minutes shall be divided into two three-minute periods. The Referee shall toss a coin and the winner of the toss may elect to go behind or underneath in the "Referee's Position on the Mat" at the beginning of the second three-minute bout, no rest period being allowed. At the expiration of the second three-minute bout, the Referee shall stop the bout and shall put the contestant who started with the Position of Advantage in the second bout in the position underneath at the start of the third three-minute bout, no rest period being allowed. If a contestant secures a fall in the second three-minute period, this terminates only the second three-minute bout and the third three-minute bout shall be wrestled as though no fall had resulted in the previous bout, except as provided in Sections 4 and 5B.

*Note.* If either contestant has brought his opponent to the mat and has been indicated as *having the position of advantage* by the Referee at any time in the first three minutes of wrestling in any dual meet match, or in any first place match in championship meets, the match goes on as a continuous nine-minute bout, regardless of the length of time either contestant may be behind his opponent and regardless of the position of the contestants at the expiration of this three-minute period. **V**

2. **Second and Third Place Matches in Championship Meets.** Second and third place matches shall consist of three two-minute bouts. The first two-minute bout shall start from the neutral position with both contestants on their feet. A fall in the first two-minute bout terminates the match. If neither contestant secures a fall in the first two-minute period, the Referee shall stop the bout, toss a coin and the winner of the toss may elect to go behind or underneath in the "Referee's Position on the Mat" at the beginning of the second two-minute bout, no rest period being allowed. At the expiration of the second two-minute bout, the Referee shall stop the bout and shall put the contestant who started with the Position of Advantage in the position underneath when he starts the third two-minute bout, no rest

**RULE 13, Section 2**

period being allowed. If a contestant secures a fall in the second two-minute period, this terminates only the second two-minute bout, and the third two-minute bout shall be wrestled as though no fall had resulted in the previous bout, except as provided in Rule 13, Sections 4, 5B. When a fall does not occur in these matches, the Referee is expected to name the winner; however, cases do sometimes occur in which neither contestant has shown any superiority whatsoever. In such exceptional matches the Referee may call for overtime bouts, after which he must name the winner.

**3. Extra-Period Bouts.** If the Referee makes no decision at the end of the main bout in dual meets or first place matches in championship meets, two extra periods of two minutes each shall be wrestled. If the Referee cannot make a decision at the end of the third two-minute bout in second or third place matches in championship meets, two extra periods of two minutes each shall be wrestled. Both of the extra-period bouts shall start from the "Referee's Position on the Mat." (See Rule 8, Section 3.) The flip of a coin by the Referee shall decide the choice of starting positions in the first bout. Position of contestants shall be reversed in the second bout.

*Note.* The term "main bout" refers to a continuous nine-minute bout or to the nine-minute bout when divided into the three three-minute periods, or to the three regular two-minute bouts in second and third place championship contests.

**4. Length of Championship Bouts When Falls Occur.** When a fall occurs in a second three-minute bout, a second two-minute bout, or a first extra-period bout of a Championship meet, it should be understood that the third three-minute bout, the third two-minute bout, or the second extra-period bout, terminates at the elapsed time at which the fall terminated the previous bout. Example: "A" wins fall in second three-minute bout with "B" in two minutes. The third three-minute bout is really only two minutes in length, as it would be impossible for "B" to win this bout after the two minutes have elapsed.

*Note.* For length of bouts when falls occur in dual meet matches, see Rule 16, Section 2A.

**5. Intermission.****RULE 13**

**A. Extra-Period Bouts.** Between the main bout and the first of the extra-period bouts a one-minute rest shall be allowed, during which time contestants shall not leave the mat. Contestants may receive aid and coaching *from one person only* during this period of rest.

**B. Two-Minute and Three-Minute Bouts.** Only such time shall intervene between the second and third three-minute bouts and between the second and third two-minute bouts as may be required for the Referee to bring contestants into proper position for the next bout, except when the second three-minute or second two-minute bout is terminated by a fall, in which case a one-minute rest may be allowed if, in the opinion of the Referee, either contestant needs the rest.

**Rule 14. Falls****1. Pin Falls.**

Pin falls only shall count. (Flying or rolling falls shall not be considered.) Any part of both shoulders held in contact with the mat for an *appreciable length of time* constitutes a fall. (By an "appreciable length of time" is meant the Referee's silent count of two seconds. The two-second count shall start only after the Referee is in such position that he knows positively that both of the defensive contestant's shoulders are in contact with the mat, after which shoulders must be held in continuous contact with the mat for two seconds before a fall shall be awarded.)

**2. Fall With Part of Body Off Mat.**

**A.** A fall shall not be awarded when one or both shoulders of the defensive contestant are off the mat.

**B.** *If the defensive wrestler is handicapped by having any portion of his body off the mat or in contact with the ropes,* the Referee shall stop the bout, which shall be resumed in accordance with Rule 9, Section 1, A, B and C, and Rule 11, Section 4.

*Note.* In the interpretation of this rule it should be understood that all parts of the body except the shoulders may be off the mat proper and still a legal fall may be called if the defensive wrestler is not handicapped by this position.

## RULE 14

## 3. Double Falls in Three-Minute, Two-Minute or Extra-Period Bouts.

A. In **Championship Meets**. In case both contestants secure falls in the last two three-minute, the last two two-minute or extra-period bouts, the match shall be awarded to the one securing the fall in the shorter time and he only shall be awarded a point for the fall. (See Rule 13, Section 1. and Rule 16, Section 1.)

B. In **Dual Meets**. (See Rule 13, Section 1, and Rule 16, Section 2.)

4. **Fall vs. Decision**. In championship or in dual meets, a fall shall take precedence over a decision.

### Rule 15. Decisions

1. **Regular Bouts**. If no fall has resulted after the expiration of the regular period of wrestling, as provided in Rule 13, Section 1, the Referee shall award the bout to the contestant *who shows greater wrestling ability and aggressiveness*.

2. **Second and Third Place Matches in Championship Meets**. If neither contestant secures a fall in the three two-minute bouts, the Referee shall award the decision to the contestant *who has shown greater wrestling ability and aggressiveness* except as provided in Rule 13, Section 2.

## 3. Extra-Period Bouts.

A. In **Championship Meets**. When no fall has been secured, the Referee shall award the decision to the contestant *who has shown greater wrestling ability and aggressiveness throughout the entire match*.

B. In **Dual Meets**. The Referee may award the decision as in A above, or he may declare the bout a draw if, in his opinion, neither contestant has shown sufficient superiority to warrant the award, in which case the points for a decision shall be divided between the contestants.

4. "**Near Falls**." Inasmuch as the primary object of wrestling is to pin the opponent's shoulders to the mat, the Referee is instructed in making his decision under Sections

## RULE 15, Section 4

1, 2 and 3 above, to give maximum credit to a contestant who makes an honest effort to secure falls, and especially to a contestant for securing "near falls."

### Rule 16. Scoring

## 1. Team Championship Meets.

A. In intercollegiate championships, first place in each weight shall count 5 points, second place shall count 3 points and third place shall count 1 point. One additional point shall be awarded for each fall secured throughout the meet. In case both contestants secure falls in second and third three-minute bouts, in extra-period bouts, or in the second and third two-minute bouts of second or third place matches in championship meets, only the contestant securing the fall in the shorter time shall be given a point award for a fall.

*Note.* For information concerning the length of these bouts when falls occur, see Rule 13, Sections 1, 2, 4 and 5B.

B. If in any championship meet, only one contestant enters and qualifies for any weight class, he shall be declared the winner of that weight class and the team he represents shall be awarded 5 points for first place, but no points shall be scored for a fall. Should only two or three contestants enter and qualify for any weight class, the contestant taking second or third place shall be awarded only 3 points or 1 point, respectively.

## 2. Dual Meets.

A. **Falls**. In dual meets, when only one of the two contestants in any match secures a fall, 5 points shall be awarded to the contestant securing the fall; but if both contestants secure falls in second and third three-minute bouts, or in extra-period bouts, the contestant securing the fall in the shorter time wins the bout and shall be credited with 5 points, but his opponent shall also be credited with 3 points for his fall. Both second and third three-minute bouts and extra-period bouts in dual meets shall run the full time unless stopped by falls.

B. **Decisions**. A decision shall count 3 points.

C. **Draws**.

(1) In case of a draw the points awarded for a decision shall be divided.

## RULE 16, Section 2

(2) In case both contestants secure falls in the same time (which is extremely unlikely), the points awarded for a fall shall be divided.

3. **Team Championship or Dual Meets.** If a contestant secures a fall in each of the last two three-minute, the last two two-minute or extra-period bouts in *Team Championship or Dual Meets*, he shall be credited only with points for one fall.

4. **Team Championship in Intercollegiate or Dual Meets.** The team securing the highest total of points shall be declared the winner.

## Rule 17. Sideline Coaching

Coaching from the sidelines or stands during the progress of a bout by the coach, team mates or spectators is illegal. (For Penalty, see Rule 11, Section 6.)

*Note.* All communication, either vocal or by signal, other than simple encouragement, by the Coach or members of the team with a contestant at any time during a match, except when time is taken out because of injury to one of the contestants, or during the intermission between the main bout and the first extra-period bout, or during intermission ordered by the Referee after a fall, shall be interpreted as coaching.

## Rule 18. Officials

### Referee's Duties.

1. The Referee shall have full control of the meet and his decisions shall be final and without appeal. (See Rule 15.)

2. Before the contestants come to the mat, the Referee should inspect contestants for presence of oily rub, rosin, objectional pads, improper clothing, finger rings, etc. He should also see that finger nails are trimmed short.

3. Immediately before each match the Referee shall call contestants to the center of the mat, where they shall shake hands and then retire to their respective corners. The Referee shall start the bout from this position.

## RULE 18

4. The Referee shall notify the Timekeeper as follows:
- A. When he starts a bout.
  - B. When time is to be taken out to bring contestants back to center of mat because of injury to a contestant or for any other cause.

*Note.* The Referee should give contestants to understand that he alone is authorized to stop the bout, and he should deal sternly with any contestant who presumes that he may stop wrestling for any cause before the Referee so orders.

C. When the bout is to be resumed (except in cases where the rules set a definite limit on the amount of time which shall be allowed). (See Rule 12, Section 1, and Rule 13.)

5. *The Referee should anticipate difficult positions on the edge of the mat and prevent them by changing direction of contestants or by bringing them to the center of the mat.*

6. The Referee shall be firm in warning contestants regarding such violations of the letter and the spirit of the rules as crawling off the mat, running away from an opponent, or any other form of stalling, in the use of such illegal holds as illegal face holds and interlocking of fingers, wrists or arms around body or legs while opponent is on the mat, the use of scissors for punishment alone, or the use of any other hold with which it is evident to the Referee that the man is playing for time or is using the same for punishment alone.

7. The Referee MUST enforce VIGOROUSLY and PROMPTLY the penalties for stalling, etc., as provided in Rule 11.

8. The Referee is instructed *not* to put his hand under shoulders of a contestant unless *absolutely necessary* to determine a fall.

9. The Referee should meet promptly, in a spirit of good sportsmanship, any situation developing unexpectedly.

10. If the behavior of the spectators becomes disrespectful or unsportsmanlike to the Referee or to either team,

**RULE 18. Section 10**

the Referee may stop the bout and warn the offenders, and if the warning is disregarded, he may award the bout or meet to the offended team.

11. The Referee's attention is particularly called to Rule 15, Section 4, and article, "Basis for Decisions," on page 44.

12. **Timekeepers.** In all intercollegiate matches, there shall be a Timekeeper, who shall be supplied with a stop-watch. The Timekeeper shall record the general time of the bout and shall call the minutes in each match in such manner that Referee, contestants and spectators may hear. Each contestant shall be allowed to have a representative at the Timer's table and the watch shall be in plain view of these representatives throughout the bout.

13. The Timekeeper shall be notified by the Referee when to start and to stop his watch, in accordance with Rule 18, Section 3. The Timekeeper shall be provided with a small caliber pistol, a loud gong or horn, by which he shall notify the Referee when the time limit of the bout has expired or when the time for intermissions has elapsed. (See Rule 12, Section 1, and Rule 13.)

### **Rule 19. Notification and Agreement of Meets**

1. In dual meets the selection of a Referee and the maximum weighing-in time shall be mutually agreed upon at least ten days prior to date of meet.

*Note.* In case the Coaches concerned are unable to agree on a shorter maximum weighing-in time than the five hours specified as the maximum in these rules, it is understood that the maximum amount of time as specified in the rules shall hold.

2. The home management shall notify visiting teams at least seven days prior to date of meet the exact time and place of match.

## **High School Wrestling Rules**

The Wrestling Rules Committee of the N.C.A.A. recommends that interscholastic Wrestling contests be governed as follows:

Wrestling rules of the N.C.A.A. as published in the Intercollegiate Wrestling Guide (Spalding Athletic Library Publication No. 429) shall apply in high school wrestling contests with the following modifications:

### 1. **Weight Classification.**

Competition shall be divided into nine weight classes as follows:

- 95 lbs. and under.
- 105 lbs. and under.
- 115 lbs. and under.
- 125 lbs. and under.
- 135 lbs. and under.
- 145 lbs. and under.
- 155 lbs. and under.
- 165 lbs. and under.
- 185 lbs. and under.

2. **No Weight Allowance.** Net weight shall be required in all dual and championship meets.

*Note.* The Committee wishes to emphasize the discouragement of any appreciable weight reduction *especially* among high school competitors, as it is much more apt to produce injurious effects if practised by growing boys.

3. **Weighing-in Time.** Contestants may weigh-in a maximum of one hour and a minimum of one-half hour before time meet is scheduled to begin.

### 4. **Legal and Illegal Holds.**

A. In addition to holds barred in College Rule 8, Sections 1 and 2, all "slams" from a standing position (Rule 8, Section 1, Note 6) and the "fall-back" from the stand-

**HIGH SCHOOL WRESTLING RULES**

ing position, the double wristlock and the head scissors, are barred.

*Note.* The term "fall-back" refers to the hard falling or jumping backward when opponent is on contestant's back in a "cross-scissors ride" or "body-scissors."

B. Penalty for infringement on Rule 4-A by offensive wrestler is loss of his position of advantage. (In case of injury to the defensive contestant by foregoing illegal holds, Rule 12, Section 3 of the Collegiate rules shall apply.)

**5. Bouts.****A. Method of Conducting and Length of Bouts.**

(1) **In All Dual Meet Matches and In All Final First Place Matches in Championship Meets**, the length of bouts shall be seven minutes or eight minutes, conducted as follows: If either contestant brings his opponent to the mat and secures a position of advantage within the first two minutes of wrestling, the bout shall become a continuous seven-minute bout. A fall in any part of this continuous seven-minute bout terminates the match. If neither contestant secures a position of advantage before the expiration of two minutes of wrestling, the Referee shall stop the bout, the remainder of which shall consist of two three-minute periods conducted as follows:

The Referee shall toss a coin and the winner of the toss may elect to go behind or underneath in the Referee's Position on the Mat at the beginning of the first three-minute bout.

The second three-minute bout shall start with the contestant who had the position of advantage at the beginning of the first bout, in the position underneath. Should either contestant secure a fall in the first two minutes of wrestling, this terminates the match. If, however, a contestant secures a fall in the first three-minute period, this terminates only the first three-minute

**HIGH SCHOOL WRESTLING RULES**

period, and the second three-minute bout shall be wrestled as though no fall had resulted in the previous bout, except, in championship meets, this bout shall end at the elapsed time of the fall in the first three-minute bout, unless previously terminated by a fall.

*Note 1.* These three-minute bouts should be conducted in the same manner as the three-minute bouts in the college rules, except that a one-minute rest period intervenes between the first and second three-minute bouts in the high school wrestling. (See College Rule 13.)

*Note 2.* The interval between the first and second place final bouts of a championship meet shall be not less than one (1) hour.

**B. In Championship Meets, in All Except Final First Place Matches**, the bouts shall be six minutes in length, divided into three periods of two minutes each. The first two-minute bout shall start with contestants on their feet as indicated in College Rule 18, Section 3. A fall in the first two-minute period terminates the match.

If no fall occurs in the first two minutes of wrestling, the Referee shall stop the bout and the two remaining two-minute periods shall be conducted in the same manner as the two three-minute periods in Interscholastic Rule 5-A. If neither contestant has secured a fall in any of the three two-minute periods, the Referee shall award the decision to the contestant who has shown the greater wrestling ability and aggressiveness. The Referee is expected to make a decision in these matches; however, cases do sometimes occur in which neither contestant has shown any superiority whatsoever. In such exceptional matches, the Referee may call for overtime bouts, after which he must name the winner.

*Note.* The last four minutes of these matches are divided into two two-minute periods, regardless of position of advantage secured by either contestant in the first two-minute period.

**HIGH SCHOOL WRESTLING RULES**

**C. Extra-Period Bouts.** When the Referee declares a match a draw at the end of the main bout, two extra-period bouts of two minutes each shall be wrestled.

**D. Intermissions.**

(1) **Three-Minute Bouts.** Only such time shall intervene between the end of the two-minute period and the beginning of the first three-minute period as may be necessary for the Referee to get contestants into their proper position. There shall be an intermission of one minute between the first and second three-minute bouts.

(2) **Two-Minute Bouts.** The same rules apply in the two-minute bouts in championship meets as in the three-minute bouts in dual meets.

(3) **Extra-Period Bouts.** Contestants shall have a one-minute rest between the end of the main bout and the beginning of the first two-minute bout and the same intermission between the two extra-period bouts.

**6. No Third Place Round.** Only first and second place rounds shall be conducted in championship meets and the loser in the final second-place match shall be declared the winner of third place.

**7. Eligibility.** Contestants shall be eligible under the rules of the State High School Athletic Association of the State in which their school is located.

**Index to Rules**

	RULE	SEC.	PAGE
<i>Bagnall-Wild Illustration</i> ..	6	5	15
<i>Bouts—Length of</i> .....	13	3	30
Extra-Period .....	13	3	32
For First Place .....	13	1	30
For Second and Third Places in Champion- ship Meets .....	13	2	31
Intermission Between .....	13	5	33
<i>Byes</i> .....	6	4	17
<i>Changes in Rules</i> .....	5	5	5
<i>Communicable Disease</i> .....	5	4	15
<i>Compete in One Class Only</i> ..	2	2	8
<i>Costumes</i> .....	3	2	11
<i>Decisions</i> .....	15	3	34
Basis for .....	15	4	44
Extra-Period Bouts .....	15	3	34
Regular Bouts .....	15	1	34
Second and Third Place Matches in Champion- ship Meets .....	15	2	34
<i>Defaults</i> .....	12	4-5	30
<i>Distinguishing Emblems</i> ..	3	3	11
<i>Drawings and Eliminations</i> ..	6	15	15
For First Place .....	6	3	15
For Second Place .....	6	6	19
For Third Place .....	6	7	21
Graphic Illustration of ..	6	5	17
Seeding .....	6	2	15
<i>Eligibility</i> .....	1	1	7
<i>Falls</i> .....	14	33	33
Double .....	14	3	34
Fall vs. Decision .....	14	4	34
Pin .....	14	1	33
With Part of Body Off Mat .....	13	2	33
<i>Holds—Illegal</i> .....	8	23	23
Bending of Fingers .....	8	1	23
Body Slams .....	8	1	23
Double Wristlock .....	7	1	23
Double Wristlock (High School rules) .....	4	A	39
Full Double Nelson .....	8	1	23
Hammerlock Above Right Angle .....	8	1	23
Holds Over Mouth, Nose, Eyes .....	8	1	23
Interlocking of Arms .....	8	1	23
Interlocking of Fingers ..	8	1	23
Interlocking of Hands ..	8	1	23
Over-Scissors .....	8	1	23
Strangle Holds .....	8	1	23
Twisting of Fingers .....	8	1	23
Twisting Hammerlock ..	8	1	23
Toe Hold .....	8	1	23

	RULE	SEC.	PAGE
<i>Injuries</i> .....	12	29	29
Accidental .....	12	2	30
From Illegal Hold .....	12	3	30
General Default .....	12	4	30
<i>Intermission</i> .....	13	5	33
<i>Mats</i> .....	3	1	8
<i>Near Falls</i> .....	15	4	34
<i>Notifications and Agree- ments</i> .....	19	38	38
<i>Officials</i> .....	18	36	36
Referee .....	18	1	36
Timekeeper .....	18	12	38
<i>Penalties</i> .....	11	27	27
For Illegal Holds .....	11	5	29
Off Mat to Prevent Fall ..	11	4	29
Off Mat Intentionally ..	11	2	28
Pushing Defensive Man Off Mat .....	11	3	28
Sideline Coaching .....	17	36	36
Stalling .....	11	27	27
<i>Platform</i> .....	3	1	8
<i>Position of Advantage</i> .....	7	1	21
<i>Referee's Position on Mat</i> ..	8	3	26
<i>Representation</i> .....	2	1	8
<i>Ropes</i> .....	3	1	8
<i>Roughness—Unnecessary</i> ..	8	2	25
Butting .....	8	2	25
Elbowing .....	8	2	25
Gouging .....	8	2	25
Hair Pulling .....	8	2	25
Kicking .....	8	2	25
Strangling .....	8	2	25
Striking .....	8	2	25
<i>Seeding</i> .....	6	2	15
<i>Scoring</i> .....	16	35	35
Championship Meets .....	16	1	35
Dual Meets .....	16	2	35
Team Championship or Dual Meets .....	16	3	36
Team Championship .....	16	4	36
<i>Sideline Coaching</i> .....	17	36	36
<i>Spectators' Behavior</i> .....	18	10	37
<i>Stalling</i> .....	10	1	27
<i>Weighing-in</i> .....	5	1	11
<i>Weight Classification</i> .....	4	1	11
<i>Weight Allowance</i> .....	5	2	13
Failure to Make .....	5	3	13

## Basis For Decisions

By R. G. CLAPP, M.D.,

Chairman N.C.A.A. Wrestling Rules Committee.

Frequent inquiries come to the Chairman of the Wrestling Rules Committee for an explanation of just what is meant by the statement in Rule 15, Section 4, that "maximum credit shall be given for 'near-falls.'" A number of different point systems have been drawn up, tried out and recommended to the Wrestling Rules Committee for adoption. None of the point systems thus far presented have been approved by a sufficient number of wrestling coaches and members of the Rules Committee to warrant adoption of the same by the Committee.

The most valid criticism of all point systems is the fact there is a wide variation in the credit which should be given for "Near-falls," "Take-downs," etc. In one case the "Near-fall," "Take-down," etc., is entirely earned by the contestant through his own aggressiveness and skill. In another case the advantage comes to a contestant who stalls because his opponent is trying to wrestle aggressively and throws himself open. The one who secures this advantage has shown no aggressiveness, cleverness, or even a willingness to wrestle.

Obviously, it would be most unfair to give equal credit in these two cases as, in the first case, the contestant has earned his advantage and deserves maximum credit, while in the second case, that contestant deserves little or no credit. It is my personal opinion that the Wrestling Rules Committee will never approve any point system which does not have sufficient range in credit allowed to properly evaluate earned and unearned advantages and the various gradations between these two extremes.

The Committee has agreed upon a general evaluation of the different essential points of wrestling and these are stated here to aid Referees in making decisions and to inform coaches and contestants of the Committee's convictions.

1. An *earned* "Near-fall" deserves much more credit than any other feature of wrestling except the fall itself.

2. *True* aggressiveness (i.e., real, continued effort to go behind opponent from the neutral position; real, continued effort to "pin" opponent when in the offensive position on the mat; and real, continued effort to escape or go behind when in the defensive position on the mat) deserves more credit than a single, earned "Take-down" or "Go-behind" from the defensive position on the mat.

3. Earned reversal of position from defensive "Referee's Position on Mat" deserves as much credit, or slightly more credit, than earned "Take-down from feet."

4. Earned "Take-down from feet" and earned reversal of position on mat deserves considerable credit.

5. Earned escape from defensive position on mat deserves about half the credit indicated in No. 3 and No. 4 above.

6. Unearned advantages should be given little or no credit.

7. Partially earned advantages to be evaluated in accordance with the degree of skill, etc., shown.

8. Stalling, waiting tactics, unsportsmanlike conduct, etc., to be scored against the offender. Such conduct might justifiably deprive a contestant of a match otherwise won.

It is the aim of the Committee to encourage active, aggressive wrestling and to discourage the waiting and stalling type. The Committee urges all Referees to follow the foregoing suggestions as the basis for their decisions and thereby help to improve the sport from the standpoint of both contestants and spectators.

## Questions and Answers

BY R. G. CLAPP.

### 1. RULE 3.

*Q.*—Are ropes required?

*A.*—No. They are not required. If ropes are not used, however, the mat should not be less than 24 feet by 24 feet. In the interest of good sportsmanship, visiting teams should be notified several weeks before date of meet whether ropes will or will not be used.

### 2. RULES 4 AND 5.

*Q.*—Is it permissible to allow slight overweight in dual meets?

*A.*—No. Contestants and coaches know the required weights and it is not good sportsmanship for a coach to ask the other coach to concede a handicap, and it is unfair to the contestant who has complied with the weight rules.

### 3. RULE 8, SECTION 1.

*Q.*—Is interlocking of hands or arms permissible after defensive man has taken one or both hands from the mat?

*A.*—No. So long as both knees are on the mat, no complete armlock is legal.

### 4. RULE 8, SECTIONS 1 AND 2.

*Q.*—Does the offensive wrestler lose his position of advantage when he is required by the Referee to break a dangerous or illegal hold?

*A.*—Yes. See Rule 11, Section 5.

### 5. RULE 8, SECTIONS 1 AND 2.

*Q.*—Should the defensive contestant be given a neutral position or position behind when the Referee stops an illegal or dangerous hold which he is using in his effort to come out from underneath?

*A.*—No. He should be put back into the Referee's Position Underneath and warned against repetition of the hold. (This applies to a double wristlock which is turned into a twisting hammerlock. See Rule 11, Section 5.)

6. *Q.*—What should the Referee do in case a hold which is usually considered a legitimate hold is forced to such an extent as to endanger a limb, or where the hold becomes purely a punishing hold?

*A.*—Referee should require the hold to be broken, time should be taken out and the contestant who had the advantage should be given the Referee's position behind.

### 7. RULE 9.

*Q.*—In resuming a match at the center of the mat, when should the Referee give contestants the same position they had when they left the mat?

*A.*—Only when a fall is imminent and the defensive wrestler *intentionally* worked off the mat.

### 8. RULE 10.

*Q.*—How long should a Referee allow a contestant to retain a stalling hold?

*A.*—If the contestant behind has been working hard and shows extreme breathlessness or exhaustion, he should be allowed to retain a hold of this nature for a short time; otherwise a period of thirty seconds or thereabouts should be sufficient for the Referee to decide whether or not the contestant is stalling.



9. RULE 11.  
*Q.*—Should the Referee penalize for stalling as promptly in three-minute bouts as in nine-minute bouts?  
*A.*—Yes, but the Referee should make his decision in such cases with little regard for the time advantage secured by either contestant.
10. RULE 13.  
*Q.*—When a main bout has been divided into three three-minute periods and a fall results in the second three-minute period, what is the length of the last period?  
*A.*—In championship meets the bout lasts only for the time it took the contestant to secure his fall in the second three-minute bout (*i.e.*, if the fall was secured in two minutes, the third bout lasts but two minutes unless a fall is secured in less time). In dual meets the third bout is a three-minute bout because the contestant who lost the fall in the previous bout is allowed the full three minutes in which to try to pin his opponent. If he pins him in less time, then he wins the bout. If he pins him in a longer time, he is credited with 3 points and his opponent 5 points.
11. RULE 15.  
*Q.*—Must the Referee make a decision in all championship matches?  
*A.*—Yes. See Rule 13, Section 2, and Rule 15.
12. RULE 14.  
*Q.*—May the Referee legally call a fall when part of the opponent's body is off the mat?  
*A.*—Yes. Any part of the body may be off the mat except one or both shoulders, provided, in the opinion of the Referee, the defensive contestant is not handicapped thereby.

QUESTIONS BY PROF. D. B. SWINGLE, ANSWERS BY R. G. CLAPP.

1. RULE 8.  
*Q.*—Is a full nelson taken with the legs illegal?  
*A.*—Yes.
2. RULE 6.  
*Q.*—In a triangular meet, how should the drawings be made?  
*A.*—Our rules provide for no different arrangement in triangular meets than in larger championship meets. Undoubtedly, however, in triangular meets with only one contestant representing each institution, a round robin would be the fairest and most satisfactory method, with an agreement relative to points for decision or fall.
3. RULE 8.  
*Q.*—Has a man on defense a right to hold his forearm against his opponent's throat so that he cannot get closer and make his hold more effective?  
*A.*—No.
4. RULE 10.  
*Q.*—When a man has a fairly good hold, say a headlock with the underarm included, can he be penalized for stalling if he holds it but is unable to pin his opponent?  
*A.*—If the hold is one with which, in the opinion of the Referee, the offensive wrestler has a fair chance to pin his opponent and is making a real effort to pin him, it should not be considered a stalling hold.
5. RULE 18.  
*Q.*—What is the penalty for fouling if no injury is done to the opponent?  
*A.*—The Referee has authority to disqualify if in his judgment the circumstances warrant it. See Rule 11, Section 5.

6. RULE 18.  
*Q.*—What is the penalty for making derogatory remarks to an opponent or to his coach?  
*A.*—The Referee has authority to disqualify the contestant if in his opinion the circumstances warrant it.
7. RULE 8.  
*Q.*—If a man in a body-scissors hooks one leg over the top toe of his opponent, does that class as an over-scissors?  
*A.*—Yes. According to the rules all over-scissors are barred.
8. RULE 8.  
*Q.*—Is a man on defense permitted to use toe holds, pressure across the face, twisting hammerlock, etc.?  
*A.*—No.
9. RULE 6.  
*Q.*—In a tournament a man is accidentally injured and thus loses a match. Can he enter his next regular match for a third place?  
*A.*—No. See Rule 12, Section 5.
10. RULE 6.  
*Q.*—In a tournament a man is accidentally injured, but wins the match notwithstanding. He defaults the next match, which comes the same day, because of the injury. Can he, the following day, compete for third place?  
*A.*—No. See 9 above.
11. *Q.*—If two opponents enter the ring dressed exactly alike and closely resembling each other, what can the Referee do to keep track of their identity?  
*A.*—See Rule 3, Section 4.
12. RULE 3, SECTION 2.  
*Q.*—Is a man permitted to wrestle barefooted?  
*A.*—No. The rules require light, heel-less gymnasium shoes laced by means of eyelets.
13. *Q.*—Can a wrestler be disqualified or otherwise punished for abusive language when not in a contest: (a) when on the bench; (b) when in the locker room?  
*A.*—The N.C.A.A. rules do not provide for such a matter and such a rule should be unnecessary in intercollegiate matches.
14. RULE 18, SECTIONS 1 and 9.  
*Q.*—If a man underneath slaps his opponent on the back, and becomes released as a consequence, and his opponent claims he thus concedes a fall, and he claims he was only trying to fool his opponent, what verdict should the Referee give?  
*A.*—The Referee should decide the matter on the basis of his judgment as to intent of the defensive wrestler, and in the interest of good sportsmanship. Trying to "fool" an opponent is not good sportsmanship and should be so interpreted by the Referee.
15. RULE 18, SECTION 4B.  
*Q.*—Under what condition is a man permitted or not permitted to take out time for lacing a shoe or other adjustment of his clothing?  
*A.*—Only when the Referee considers it necessary and so orders.
16. RULE 9.  
*Q.*—If a man is temporarily injured when a fall is imminent, what positions do the men take when they continue after the three-minute rest period?  
*A.*—The bout should be resumed as in Rule 9, Section 1.

## 17. RULE 8.

*Q.*—If the man behind on the mat clasps his arms about his opponent's waist and one arm, is this an illegal hold?

*A.*—Yes.

## 18. RULE 8.

*Q.*—If the defensive man frees himself from a dangerous hold by pushing against the face or throat or by twisting the fingers, what is the penalty?

*A.*—No specific penalty is provided and the Referee should decide the matter on the merits of the case.

## 19. RULE 2, SECTION 2.

*Q.*—If in a tournament a man who is a lone entry wrestles in one weight (say 165-pound class) the first day, can he drop back to a lighter class (say 155-pound) the next day if his weight will permit?

*A.*—No. He would be allowed to drop back to the lower weight on the first day before drawings are made for that class if he should see fit and if his institution is not represented by another contestant in that class.

## 20. RULE 2, SECTION 2.

*Q.*—If in a tournament a man is injured in the first round, can a reserve be put in his place for a later round?

*A.*—No.

## QUESTIONS BY DR. J. A. ROCKWELL, ANSWERS BY R. G. CLAPP.

## 1. RULE 15, SECTION 2-A.

*Q.*—Might a situation arise where two contestants are evenly matched and overtime periods fail to disclose any advantage when a draw might be the only decision?

*A.*—See No. 11 in "Q. and A." by R. G. Clapp.

## 2. RULE 12, SECTION 4.

*Q.*—If second place defendant defaults, what score is the other man entitled to?

*A.*—Three points for second place and one point for fall—total, four points.

3. *Q.*—Should not Timers call out the passing minutes so distinctly as to be heard by contestants, coaches and spectators?

*A.*—Yes.

## BY W. C. O'CONNELL.

## 1. RULE 10.

*Q.*—A man secures a riding-scissors and merely holds his opponent down, not being in a position to secure a fall and making no effort to secure a fall. Would this be construed as stalling?

*A.*—Yes.

## 2. RULE 8, SECTION 1.

*Q.*—Man underneath raises both hands from mat and sits back on haunches at the same time using his hands in an effort to escape. Can top man lock hands or arms around him?

*A.*—No. Underneath man is still on the mat.

## 3. RULE 8, SECTION 1, NOTE 3.

*Q.*—Man underneath raises one knee from mat in an effort to escape. Can underneath man lock arms or hands?

*A.*—Yes. In order to prohibit locking of arms or hands, opponent must have both knees on mat.

## Instructions to Referees and Suggestions to Coaches

By R. G. CLAPP, M.D.,

Chairman N.C.A.A. Wrestling Rules Committee.

### 1. WARNINGS BY REFEREES REGARDING STALLING

Rule 11, Section 1 (A and B), of the National Collegiate code, in the past, required the referee to penalize contestants for stalling on first offense, but most referees have hesitated to penalize as required by the rules. Therefore, the Rules Committee, after a lengthy discussion of this matter, decided that it would be fairer to all concerned to provide for a single warning. With this new provision there seems to be no logical reason why the referee shall not strictly enforce the rule, and the committee expects all referees to do so.

### 2. DANGEROUS HOLDS

Rule 8, Section 2, provides that anything which endangers life or limb is barred under the intercollegiate wrestling code. Recently the attention of the committee has been called to rather serious accidents which have resulted from the use of the "Japanese keyhold". Referees should bear in mind that much damage to intercollegiate wrestling may result from any serious accident in competition, and therefore all referees should be alert to prevent the use of dangerous holds before injury results.

Furthermore, no contestant should ever be put in a position where he must yield a fall to avoid injury to a limb or to escape severe punishment. Intercollegiate wrestling is a contest of strength, speed and skill, and not punishment, and referees are expected to require contestants to break holds which endanger life or limb, and which are primarily punishing holds. No contestant should be allowed to retain any advantage which he has secured through use of an illegitimate hold.

### 3. REFEREE'S DECISION

Unfortunately it still seems necessary to call the attention of referees to the fact that decisions should be made on aggressiveness and wrestling ability, and not on time advantage.

In cases where the offensive wrestler has not shown superior aggressiveness and wrestling ability but has been content simply to retain his position behind, the referee is expected to call for extra period bouts even though he may know that the offensive wrestler has a considerable time advantage.

### 4. FALLS

Referees should bear in mind that both shoulders of the defensive wrestler must be held in continuous contact with the mat for a full two seconds before a fall shall be awarded, and that the two-second count shall not start until

the referee is in such position that he can see clearly that both shoulders are touching the mat.

### 5. DISCOURAGE DEFENSIVE STALLING

When a defensive wrestler in the under position on the mat "closes up" and refuses to work except to prevent a fall, the referee should promptly give the two warnings required in Rule 11, Section 2B, and if the defensive wrestler still persists in doing this after the warnings, the referee should award a fall to his opponent.

### BARRING DANGEROUS HOLDS

Many requests have come to the Wrestling Rules Committee recently to add holds to the list of those already barred. These requests usually have been made because of injuries resulting from the use of certain questionable holds. The committee has taken the general stand that it is not advisable to have a long list of holds specifically barred, inasmuch as every really dangerous hold is covered under Rule 8, Section 2. The committee believes that college wrestling coaches know what holds come within the letter and spirit of our intercollegiate rules, and that coaches should avoid teaching or allowing any and all holds which are outside the spirit of the rules. The coaches hold, primarily, in their own hands the key to increased popularity and development of intercollegiate wrestling. The coach should discourage any and all holds which might result in serious injury to contestants as well as jeopardize his own personal interests through possible elimination of wrestling as an intercollegiate sport at his institution.

### TRY OUT SUGGESTED CHANGES IN RULES

A large number of suggestions relative to changes in intercollegiate rules, some of them quite radical in nature, have been brought to the attention of the Wrestling Rules Committee. The committee suggests that coaches who recommend radical changes in rules try to arrange with coaches of teams with which they compete, to conduct an occasional dual meet under the changes suggested. It would be of great value (to the committee) if the coaches would try out the various changes before they are recommended (to us) for adoption.

## Medical Suggestions for Protective and Preventive Measures

BY JOHN A. ROCKWELL, M.D.

The athletic programs in our colleges today are the culmination of evolutionary steps through years of transition from the individual effort to the group or team competition. They may be intramural or intercollegiate in nature.

Our present aim is to foster such healthy and manly contests and to offer every advantage to the participant for his enjoyment of the game, as well as for improving his physical and moral upbuilding.

In wrestling we meet with unusual demands which call for strength, intelligence, courage and fine sportsmanship. The National Collegiate Wrestling Rules Committee feels that the present rules offer the greatest opportunity possible for the individual's benefit, without deleting too severely that which is of interest to the sport-loving public.

The wrestling game is a rugged sport and quite innocently and unintentionally injuries to bones, muscles, ligaments, fingers, ears and skin may result during practice or championship bouts, notwithstanding the present regulation of the sport.

It therefore becomes the imperative and absolute duty of the coach and captain to protect their squad from any or all of these possible emergencies. The preventive measure of keeping clean the equipment, as well as the bodies and garments of contestants, is essential. Injuries should be anticipated when possible, and no candidate should be allowed to compete if structural damage is even suspected. Medical advice should be sought early in these cases.

The following two situations are detailed as guides to those in charge of candidates who may require special attention. The Rules Committee felt that this simple procedure might be of assistance to coaches and physicians in meeting any such complications.

### Impetigo

BY JOHN A. ROCKWELL, M.D.

"Impetigo contagiosa is a contagious disease of the skin, characterized by vesicles, pustules and superficial crusts, usually occurring on exposed portions—the ears, neck, face and hands—devoid of subjective sensations, and terminating without sequels." (TILBURY FOX.)

This disease is a pus infection. Abrasion of the skin surface from any cause is the entering wedge of this most contagious of the commoner skin diseases. The infection may be streptococci, staphylococci, or combined. A large number of observers have examined the lesions bacteriologically and find the majority are of staphylococci origin.

The discreet, vesicular, pustular and crusted lesions of impetigo are readily distinguished from pustular eczema by the presence in the latter of infiltration, weeping, *itching*, and the occurrence of *large* patches.

In impetigo proper the *early* lesion is a flat and erythematous (reddened) spot, which soon changes to a blister. This blister rapidly changes to a pustule which subsequently dries, forming a superficial crust.

These crusts are gummy-like, yellowish, very superficial, and appear as if stuck to the skin. They extend beyond the margin of the original area with their edges somewhat freed at the border. This crust is easily removed and the underlying skin area, which is of superficial nature, with its distinct marginal

outline, presents a weeping surface which, in turn, dries and is the base of another crust formation. These areas vary in size from a pin head to that of a dime, or even larger.

Because of the non-irritating nature of this disease, it is frequently disregarded and considered merely as a so-called fever blister. Before the individual is aware of the true nature of his skin condition, he may have transmitted the infection to others. It therefore becomes the duty of any coach, manager or captain of a group of athletes, to note carefully any skin affliction appearing in his squad.

*Treatment:* Absolute cleanliness precludes any chance of contagion. The preventive side, therefore, constitutes the initial treatment. Wrestling covers, clothing and the individual contestant should all come under the observation and general inspection of the authorities in charge of the health program. Through carelessness, neglect and unintentional disregard of a skin lesion by the individual, whole squads have been known to become the victims of impetigo, with the resulting cancellation of intercollegiate contests.

The scales, or crusts, should be carefully removed and burned or otherwise destroyed. The underlying reddened moist surface is then firmly wiped with cotton or gauze saturated with any antiseptic lotion (bleach solution, 1:2000; saturated boric acid solution, a permanganate of potassium solution; hexylresorcinol, 1:1000; metaphen, 1:2000, etc.). When the areas have been thoroughly washed, using firm pressure on the cotton applicator, the surfaces should be anointed with some mercurial ointment. Ammoniated mercury ointment, 4 to 10 per cent, is the standard application. The procedure should be repeated once or twice daily until all signs of crusting and oozing of the various areas have subsided.

Athletes inflicted with impetigo should not compete in contact sports while under treatment. There is no objection to the individuals exercising in the open air for conditioning purposes. Their linen and towels, brushes, combs and other toilet articles should be either destroyed or thoroughly soaked in any of the numerous antiseptic solutions and placed in the sunlight for drying.

*Note:* Whereas persistent, careful and thorough treatment of impetigo is essential, it is quite possible to apply an aggressiveness of treatment over and above the required measures necessary and create an irritation of the skin, resulting in an eczema, or some other complication.

Whereas, in adults, impetigo is a purely local condition causing no constitutional symptoms, the general laws governing hygienic living should be rigorously adhered to, such as adequate nourishment, taking freely of fluids, good elimination, systematic exercise and regular hours of sleep.

## Watch the Ears Carefully

By DONALD B. SINCLAIR, M.D., PRINCETON UNIVERSITY.

The external ear is, to all practical purposes, a sandwich, with a single layer of cartilage between two layers of skin. These layers of skin are not very tightly attached to the cartilage, and any hard rubbing or rolling motion separates the skin from the cartilage, much as the skin of a peach can be rubbed off the fruit. The bleeding caused by this separation, though not visible on the surface, makes a pool of varying size between the skin and cartilage, and, if not properly and promptly treated, the blood first clots, and then changes into definite solid tissue, making that part of the ear hard and thick—the familiar cauliflower ear.

The treatment of this condition divides itself naturally into two classes—prevention and cure. In the realm of prevention, there are several designs of helmets which can be used in practice, to avoid the development of a large number of injured ears.

After the first injury, however, when the hematoma, or blood clot, has been formed, the need for cure appears, and it is here that most of the bad results that one sees, have their start. The ideal treatment of the condition, from this point on, consists of two parts: (1) relief of the swelling already formed, and (2) avoidance of further injury, until the affected part has had a chance to return to normal. The swelling can best be relieved by the immediate removal of the blood under the skin. This is most satisfactorily accomplished by aspiration of the fluid blood with an ordinary hypodermic needle and syringe; but this *must* be done under strict aseptic precautions, and by a properly qualified doctor, for the danger of infection in freshly damaged tissue is very great. A pressure dressing is then applied, to prevent further seepage of blood or serum between the skin and cartilage. This dressing may be of a number of types: pads of gauze, held in place with tight adhesive strips, with or without the addition of sponge rubber pads for additional pressure; or a pad of cotton and collodion, applied to the whole ear, from the middle out to the surface, in thin layers laid on successively, each layer being allowed to harden before the next is applied. The latter type is probably more comfortable than the dressing of gauze with tight pressure, but in severe cases the heavier pressure may be found necessary, at least for a time. In mild cases this treatment alone—aspiration plus the collodion dressing—may be sufficient. In severe cases it may be necessary to have the ear aspirated a number of times, to get rid of the serum that will collect, even after all active bleeding has ceased; the pressure bandage being replaced immediately after each aspiration.

In the meantime, until the ear has returned to normal, and all tendency to fill up again has disappeared, the wrestler must not risk any further injury, either refraining from wrestling altogether, or doing so only with adequate protection in the form of a headguard.

An ear which has already reached the typical cauliflower stage—hard, deformed and hideous—can be repaired and brought back nearly, if not quite, to normal contours, through the services of a capable and experienced plastic surgeon.

## Dehydration

By DR. JOHN A. ROCKWELL, MASSACHUSETTS INSTITUTE OF TECHNOLOGY.

The following paragraphs express the views of a few physicians interested in physical education and the intelligent physical development of youth: without carrying the athletic program to the point of excess and strain to the individual, to say nothing of permanent injury. The point which I was asked to consider in detail was that of making weights.

Our first interest should be for the welfare of our young athlete, not only to protect him by having specified weight classes, but to prevent any drastic measures which, when used, find him in a lower weight class than the one in which he naturally should be placed. There is no objection to conditioning a man who has gained weight during the summer holidays. In this group, the training process, no matter what department of physical exercise he selects, takes care of itself. Our endeavor is to protect the man who is down to his best weight but yet finds himself five or six pounds above the class he hopes to make and then strip him of these pounds through dehydration, that he may be able to compete in this special class. This is the danger which many coaches fail to realize and which has prompted this constructive criticism of a truly pernicious practice in contests where the necessity of "making weights" is required.

The process known in the medical discussions as dehydration is the removal of body fluids to a point where first the kidneys, then the heart, and finally, the muscles, become taxed well beyond their normal physiological limits. Any athlete entering a rigorous contest dehydrated, immediately finds himself at a disadvantage because of kidney, heart and muscle deficiencies. He competes with uncertain results as to victory, but with definite results as to increasing the strain on these **three groups of tissues**. Any injury which may not be fully recognized at the moment often forms the basis for true pathological conditions and, in certain instances, has demonstrated definite permanent injuries to the individual as a consequence of this vicious weight-making process.

Following a full discussion of this question and to prevent certain coaches who are indifferent to the individual's health because of a desire to have a winning team, the Eastern Intercollegiate Wrestling Association adopted two new rules governing their intercollegiate championships: *i. e.*, (1) Net weights for intercollegiate wrestling on the day before the finals and one pound allowance on the day of the finals; (2) The "weighing-in" time to be not longer than three hours before the contest. By circumscribing these two mooted questions of "making weight" and "weighing-in" time with the foregoing rules of limitation, it is hoped to prevent any further practices which an indifferent coach or captain may be guilty of exercising in future contests. Many coaches have learned to their sorrow that this practice has so enervated their prospect in the class entered, that he has failed to make a good showing, which condition would not have maintained had he been in his best physical condition, even in a higher class.

These points cannot be emphasized too strongly, and it is the hope that all coaching forces interested in wrestling, boxing and 150-pound crews, etc., will have this matter brought very definitely to their attention. It is a subject which should have the sanction of all the prominent medical advisors.

The National Intercollegiate Rowing Association in 1925, after an extended discussion on this subject, voted for net weights in their 150-pound crews. In eight-oared shells it is an advantage to have extra weight in the waist of the boat. To meet this necessity, a 5-pound overweight allowance is permitted for those men occupying this position. The sum total of the eight men, however, must be an average of not more than 150 pounds per man. At this time, emphasis was placed on the permanent injury which may and does come to athletes who force themselves to a weight below their best and safe physical efforts.

## Attention to Details will Ensure Safety

By HUGO OTOPALIK, IOWA STATE COLLEGE.

The N.C.A.A. Wrestling Rules Committee recently suggested that the coaches' association send out a questionnaire dealing with injuries caused while wrestling. This questionnaire was compiled and mailed to approximately a hundred coaches in colleges, athletic clubs, Y.M.C.A.'s and high schools. Few responded with information, due either to lack of interest or because they felt the information of no moment, or it might have been that they had no injuries to report. The fact that coaches who returned blanks had charge of approximately a thousand wrestlers, ranging in age from 17 to 24, the average being 20 years, and their weights varying from 95 to 200, with an average of 145 pounds, may be of interest. There were more injuries in the lighter four weights than in the heavier classes. Of course there are more wrestlers in the lighter weights in all schools.

Considering the number of injuries among this one thousand men participating in wrestling, it may be truthfully said that incapacities were very few when compared with a majority of other sports, and certainly there have been practically no serious or permanent injuries. Cauliflower ears take first rank in the number of injuries, and this probably is the most serious objection that can be brought up against this ancient sport.

Infections caused by improper care of mat burns, scratches, etc., come second. It is brought out that unsanitary rooms, mat covers and unclean clothes are a great factor in these infections. Broken bones, dislocations and sprains come next in order, and these are caused primarily by body slams, use of wristlocks or hammerlocks, or tripping over loose mat covers and falling to mat. Practically all dislocations occurred at the elbow, and sprains at the shoulder.

As may be expected, the greater number of injuries occur to beginners or those who are not in the best of physical and, it might be said, mental condition.

The general causes of injuries as reported by the coaches were as follows: Use of headlocks, body slams, head scissors, keylock, wristlock, falling on shoulder or elbow, falling or tripping over loose covers, improper use of switch, blocking the wristlock, and falling on bare floors, surrounding the mat proper. One case of cauliflower ears was caused by wrestling while the ears were frozen, and another reported that "plain, dumb clumsiness" caused a dislocated elbow.

It is interesting to note that a large majority of injuries were received when the injured man was in defense. It would seem then that we should train and coach our men to use offensive tactics more than they have in the past. Holds used when injuries occurred were declared legal in practically all cases; only two were noted otherwise.

It was while at practice that most injuries took place. Possibly wrestling too carelessly or loosely, or being unfamiliar with the dangers, caused the accidents. There were as many mishaps in the early part of the bouts as in the latter part. Strange as it may seem, most injuries occurred in the latter part of the season at a time when the men are supposed to be in the best condition. None of the coaches admitted their men were wrestling with superior opponents. It might be the "tougher competition," or it might be carelessness or staleness, when a greater number of accidents occur in the latter part of the season.

In the main the injuries that were reported incapacitated the men for the remainder of the season. The average loss of time was three weeks. In every

case the coach was present when injuries occurred, and in only one or two instances was improper equipment the cause.

Let it be said here most emphatically, that in a sport such as wrestling, where most serious injuries often occur, no boys should be allowed the use of the wrestling room and mats without proper supervision at any time.

It is good to hear that many coaches had no injuries whatsoever, while others reported a considerable number. As a whole the coaches seem satisfied with the present rules, although the following suggestions were offered to bring about a more satisfactory state of affairs in amateur wrestling:

"Compel the officials to learn the rules and enforce them as they should be."

"Eliminate the head scissors; it is a dangerous hold and repulsive to the spectators; too many bad ears result from its use."

"No injuries to speak of this year; a couple of bad ears caused by head scissors and headlocks; cut out the head scissors."

"Wrestling and all personal contact sports will always provide accidents; leave the rules alone."

"We need more definite legislation in regard to double wristlocks. No two officials have the same idea about coping with the delicate situation that comes up when the wristlock is used. Rules are not definite enough on this point. Bar the wristlock if we can't agree on how it should be handled."

"Unrestrained and impetuous eagerness among beginners has been largely responsible for injuries sustained by my group of wrestlers."

"We did not have a single injury that required the attention of a doctor or nurse, in spite of the fact that we have 145 boys reporting. We stress the reporting of the slightest injury and the necessity of proper care."

"'Bad ear': this is the only injury of any kind I have experienced on my squad in five years."

"No injuries except one bad ear and a couple of boils. There have been injuries in wrestling, but half have been the fault of the referee for not stopping abuses that cause injuries. It will be a good thing to determine what is the cause of injuries. Infections and boils can be educated out of the wrestling business. Wrestling half speed causes most injuries, or the misuse of wristlocks."

"Prohibit double bar arm over head; educate the referee more; prohibit use of scissors for punishment; compel coaches to submit lineup at least one-half hour before meet starts."

"Good coaching and proper training, a larger and thicker mat cover, good and clean covers daily, plenty of space around mat, covered walls, good ventilation, sunshine, tight mat covers, good clothing for wrestlers, headgears, personal cleanliness, alcoholic rub after workout, prevention of colds, will help make wrestling a better and safer sport for our boys."

One of the more serious sides and more harmful phases of the game is the unforgivable excessive weight reduction as practiced by a few thoughtless coaches. There probably isn't another single factor that parents and physical education authorities object to in wrestling as this malicious practice; any number of cases may be mentioned where during "college days" a boy has been starved and dried out to such an extent that he never returned to normal weight.

The Big Six conference directors, seeing the dangers, have made a move in the right direction when a ruling was passed in the spring of 1935, compelling wrestlers to weigh in not earlier than one hour before competition begins. This should to a great extent, stop this obnoxious practice and should equalize competition.

## Popularizing Wrestling in School and College

BY W. AUSTIN BISHOP.

*Coach of Wrestling, University of Pennsylvania.*

Reliable reports from several sections of the country, notably Long Island, northern New Jersey, western Pennsylvania, eastern Ohio, and Oklahoma, indicate that numerous schools and colleges have recently made provision for the inclusion of wrestling in their athletic programs. Student-participation and spectator-interest in certain other geographical areas have shown steady and substantial growth tendencies. The time is soon at hand, we hope, when wrestling will be recognized universally as a desirable developmental activity and a valuable educational experience.

There are unfortunately some parts of the country still in which school and college wrestling activities are nonexistent. From these quarters come frequent inquiries from wrestling enthusiasts asking what they might do to correct this anomalous situation. Without claim to magic formulae or to any one infallible solution to the problem, we shall present herewith several procedures which have been found to be successful in stimulating student and spectator-interest in wrestling in both secondary schools and colleges.

### HOW TO INCREASE STUDENT-PARTICIPATION.

The underlying success factor in any popular school or college wrestling program is intelligent and inspiring leadership. Centers of keen interest, such as Oklahoma A.&M., Lehigh, and Franklin and Marshall are not the result of some spontaneous interest phenomenon peculiar to the particular sections in which these institutions are located. Instead, they reflect the effective promotional efforts of three great sports leaders—Coaches Gallagher, Sheridan and Mays, respectively. Confirmed in the belief that the experiences of the wrestling room would contribute to the well-being of most college men, these practical educators set out independently to serve as large a number of them as possible. The winning proclivities of their teams were, and are still, the incidental by-products of the instructional and conditioning processes. The perennial efficiency of these institutions in intercollegiate competition is due in no small part to the large number of boys aspiring to team membership. The significant contributions of these programs, however, is the rich measure of physical, mental and moral development experienced by the host of boys who never "make" the team.

Strangely enough, the boys who most need the benefits of athletic training are frequently the last to seek them. For these boys I know of no more effective approach than a direct and personal invitation to join the squad. Convince them of the values to be gained and refuse to take "No" for an answer. They will thank you later.

Never exploit a beginner. Induct him carefully and progressively into the several phases of the game. Do not over-match him; provide an early oppor-

tunity for success. "Exposure" during the first week or two of practice frequently determines whether he will become a real wrestling enthusiast or just another "never again."

Call attention frequently to the skill of other members of the squad who were once beginners. Encourage novices to study the styles of these men. Assign to each expert wrestler one or more novices for whose progress he is to be held largely responsible.

Urge older members of the squad to recruit new candidates. Impress upon them the value of this form of service and insist on its being taken into account when the time comes to select a new captain.

Invite famous wrestlers to frequent the wrestling room. Have them demonstrate their favorite holds and work out with your more advanced students. Encourage students generally to come out occasionally to see the squad practice.

Publicize wrestling activities within the school. Exhibition matches, comedy skits, slow-motion demonstrations of holds, and rules interpretation clinics have been successfully presented in the form of assembly programs. Motion pictures of the matches of the National Collegiate Championships\* have also been used with gratifying results.

The sport never suffers from the lack of newspaper publicity when the sports writers once get the notion of "what it's all about." It is the responsibility of the coach to make a wrestling expert of every correspondent of his acquaintance. It is well to remember that most boys prefer to engage in a sport in which some spectator-interest is manifestly present.

Use every means at your disposal to educate the community concerning the essential differences between amateur and professional wrestling. Emphasize the positive values of the sport as a school and college athletic activity.†

Provide appropriate awards. Recognize the "most valuable" and the "most improved" members of the squad. Major awards should occasion impressive presentation ceremonies, preferably as a part of the assembly program.

Organize a chapter of the "Grapplers' Club"‡ devoted to the perpetuation of wrestling at your institution and to the promotion of good fellowship among the undergraduates and alumni interested in the sport. Carefully conceived membership requirements will serve effectively in promoting loyal and faithful service to the squad.

Have this wrestling club sponsor annual banquets honoring the team and encourage members of the squad to bring their fathers and friends with them. Alumni members will welcome this opportunity to renew old friendships and to make new acquaintances. They will welcome the opportunity, too, of finding ways and means of further promoting the welfare of the sport of their choice.

Finally, make the instructional program itself as attractive and stimulating as possible. Divide your efforts and attention fairly among all members of the squad. Neglect no one. Provide at least one new learning experience daily. Carefully guard against monotony; do not allow a pleasurable pastime to

become sheer work and drudgery. To most boys, practice and training are merely means to an end. The ultimate objective is the thrill and satisfaction of actual competition with a worthy opponent. It is important, therefore, that opportunities for competition of some kind or another be provided for as large a number of boys as possible. The coach who sponsors an attractive program of intramural activities and arranges schedules of dual meets for two or three teams will have little difficulty in attracting to his sport as many boys as he is able to accommodate.

#### HOW TO STIMULATE SPECTATOR-INTEREST.

Obviously the most effective way of getting a large crowd out to see your team is to develop a championship combination. Nearly everyone likes a winner. There are times, however, when the team will not win consistently. Unless the coach has been educating the spectators meanwhile to the point where they are able to understand, appreciate and enjoy a scientific wrestling contest despite the outcome, they will desert the team when it loses. Lehigh University wrestlers may well look forward to a capacity crowd for every home meet whether their team is of championship caliber or of mediocre quality. The fact is that students and townfolk alike, know and enjoy good wrestling. Lehigh may win, lose, or draw, but the fans will turn out to see them do it.\*

Consequently, it is essential that every effort be made to educate the spectator. Printed or mimeographed programs, with an explanation of the more salient rules, demonstrations of legal and illegal holds before the meet, and more recently the use of objective point systems employing scoreboards, have all been used with some measure of success to make wrestling fans of casual spectators.

\*Bishop, W. Austin: "What's Wrong With the Game?," pp. 51-52, N.C.A.A. Official Wrestling Guide, 1937-38 (Spalding Athletic Library No. 118R).

\*Films may be rented at nominal cost. Apply to Dr. R. G. Clapp, University of Nebraska, Lincoln, Neb., or to Mr. E. R. Patterson, Kansas State College, Manhattan, Kansas.

†University of Michigan study on comparative developmental results. Write Coach Clifford Keen, University of Michigan, Ann Arbor, Mich.

‡Scholastic achievement among college wrestlers: See Carnegie Foundation report.

§Successful clubs in operation at Syracuse, Columbia and Pennsylvania.

## Training Wrestling Officials

BY BLISS P. SARGEANT, JR.,

*Professor of Health and Physical Education, Springfield College.*

The course in Wrestling Officiating offered at Springfield College began in 1935 as an outgrowth of the writer's experience and firm belief that one of the main difficulties impeding the progress of intercollegiate wrestling was the lack of properly trained intercollegiate wrestling officials.

The materials of the course were presented through a combination of lecture, demonstration and active participation by all members of the class. The major portion of the time was spent on intercollegiate rules, although ample opportunity was provided to cover interscholastic, A.A.U. and Olympic rules. During the practical part of the course, actual wrestling meet situations were staged and each class member had an opportunity to act in the capacity of official, coach, timer, announcer, manager, spectator, etc. A one-hour final examination in theory was given at the end of the course. Many of the men received additional practical experience by officiating in local meets. Each class from 1935 to 1937 averaged approximately nine members.

In 1938 the course was combined with several others into a General Sports Officiating course. The enrollment increased to twenty-eight members. Supplementary to the regular class work, each student was required to chart at least ten different wrestling bouts for data, which tends to develop one's interest and to increase one's knowledge of the sport. Each student was also required to hand in a written report on at least two wrestling officials whom he had observed in action. (The "Wrestling Data" and "Report on Wrestling Official" mimeographed sheets may be obtained from the writer upon request.)

A brief outline of the additional material covered in the course is as follows:

- (1) Introduction and brief history.
- (2) Cooperation of Wrestling Officials and Athletic Departments.
- (3) Wrestling officials' qualifications and duties.
- (4) Wrestling officials' code of signals.
- (5) Present rules vs. proposed changes.
- (6) Suggestions to wrestling coaches from the officials' viewpoint.
- (7) Suggestions to wrestling officials.

The results accruing from this course have been very gratifying, and it is my belief that each prospective wrestling official should receive such essential training. This training could be secured in the following manner:

Rules interpretation meetings for coaches and officials should be held each year in each district at the beginning of the wrestling season. These meetings should be in charge of a member of the N.C.A.A. Wrestling Rules Committee or a member of the Advisory Committee. I have discussed this problem with many coaches and officials and they agree that if wrestling clinics of this nature were held each year it would enable both officials and coaches to secure more uniformity of knowledge concerning interpretation of rules. This would tend to eliminate to a large degree the intense feeling which oftentimes arises between coaches and wrestlers and the officials.

At the present time many coaches and officials seem to be at a loss in their attempts to definitely decide just how the winner of a wrestling bout should be determined. Since, in one sense, our rules are very subjective, we should require our officials to be trained to a certain high standard of proficiency in their interpretation of rules. At present many officials use their own interpretations simply because we have no organization of wrestling officials that aims at the development of this particular phase of the sport.

Should we not form a National Wrestling Officials Association and cooperate with the National Collegiate Wrestling Rules Committee and the National Collegiate Wrestling Coaches Association to establish standard rules and interpretations that may be carried to all parts of the country? If not, then I believe we are "stalling" and the public will penalize us even more than they have in the past decade.

After a set of standards is firmly established, then each prospective official should be required to pass a practical examination and a written theoretical examination to the satisfaction of a district examining board before becoming certified. Certification in this manner would certainly improve present standards. In addition, it would be an easy matter for each certified official to keep up to date by attending his district meetings at the beginning of each season. For best results, such meetings should also be held at the close of the wrestling season—perhaps at the time of the conference championships. All recommendations from each district could then be forwarded to the National Wrestling Rules Committee for consideration.

Certified officials qualified in this manner will enforce the rules as written and in a few years we will be in agreement upon adopting a standard set of rules which will need little or no revision from year to year.

### Coaches and Contestants—Attention

Much severe criticism of amateur wrestling is caused by the disgusting, unsanitary, and usually unnecessary habit of many wrestlers of expectorating on the wrestling mat or on the floor outside the mat, blowing the nose without use of handkerchief, wiping the nose with the back of the hand and then wiping the hand off on the trunks, etc. Such habits are repulsive to people of culture. The foreign representatives at the Olympics at Los Angeles in 1932 were astonished at the degree to which this was prevalent among our wrestlers. I am informed that many ladies refuse to attend wrestling matches for this reason. There are so many good reasons against and none for these practices that all interested in the development of amateur wrestling should cooperate in the elimination of this evil. The following suggestions, if carried out in both practice and competition, would unquestionably eliminate these practices in a comparatively short time: First, education of the contestants by the coaches as to the detrimental effects of these practices; second, if it is considered necessary (which I personally doubt) for the contestants to have something into which to expectorate during matches, two small boxes of sawdust should be placed at opposite corners of the mat; and, third, much preferable to the second suggestion, require each contestant to carry a small handkerchief somewhere in his "jeans" and use this when necessary. The latter custom is quite common among foreign wrestlers.



# • TOURNAMENTS •

## National Collegiate A.A. Championships

By Charles M. Speidel, Wrestling Coach, Pennsylvania State College.

The eleventh annual National Collegiate Athletic Association wrestling championship tournament was returned to the East in 1938 and held in the spacious Recreation Hall of Pennsylvania State College, at State College, on March 25-26, 1938. Eighty-six wrestlers from twenty-nine colleges in sixteen states took part in the tournament.

The Cowboys from Oklahoma A. & M. maintained their monopoly on the team title, scoring 19 points to 15 for Illinois and 12 for Indiana. It had been expected that the tourney would be a walkaway for the team coached by the veteran Ed Gallagher, but surprising opposition came from the midwestern colleges.

The tournament was a championship of champions, with all the sectional leaders represented. Newcomers to the Nationals were Utah State, San Jose College of California, and City College of New York.

Competition was keen and a great deal of clever wrestling exhibited. Of significance was the interesting variance in wrestling styles demonstrated by grapplers from the different sections. It was also interesting to note that a few of the better Eastern competitors showed the most open style, and because of the variety of their maneuvers proved most entertaining for the spectators. This was particularly true with respect to Dick Harding of Princeton, who had reached the semi-finals, and Curtis Ford of Lehigh, a finalist in the 165-lb. class.

Lads from the Big Ten seemed generally more rugged, and for the most part were conservative, cautious wrestlers. From the West and Southwest the boys were versatile and skilled enough to adapt a style necessary for any particular bout. The knowledge, experience and general equipment of the Oklahomans was again much in evidence, but it was heartening for other coaches to note marked improvement in the representatives of other sections.

It was the general opinion of the coaches that the rule changes brought about a more aggressive, popularized style in the 1938 tournament and that the elimination of the watch had in turn eliminated a good bit of offensive stalling.

The organization and management of the tournament on the part of the Rules Committee, Penn State Athletic Association officials and student managerial staff was highly efficient and especially reflected credit on the tourney manager, George Jarden, who not only directed the thousand-and-one details to perfection but handled the public address system like a professional.

For the consideration of future tournament managers it might be pointed out that the finals, for the first time, were run off without the distraction of second and third place bouts going on simultaneously. This was a popular move from a spectator standpoint and improved the "staging" of the affair from a dramatic angle. In this respect, Klieg lights and low overhanging lights, with movie

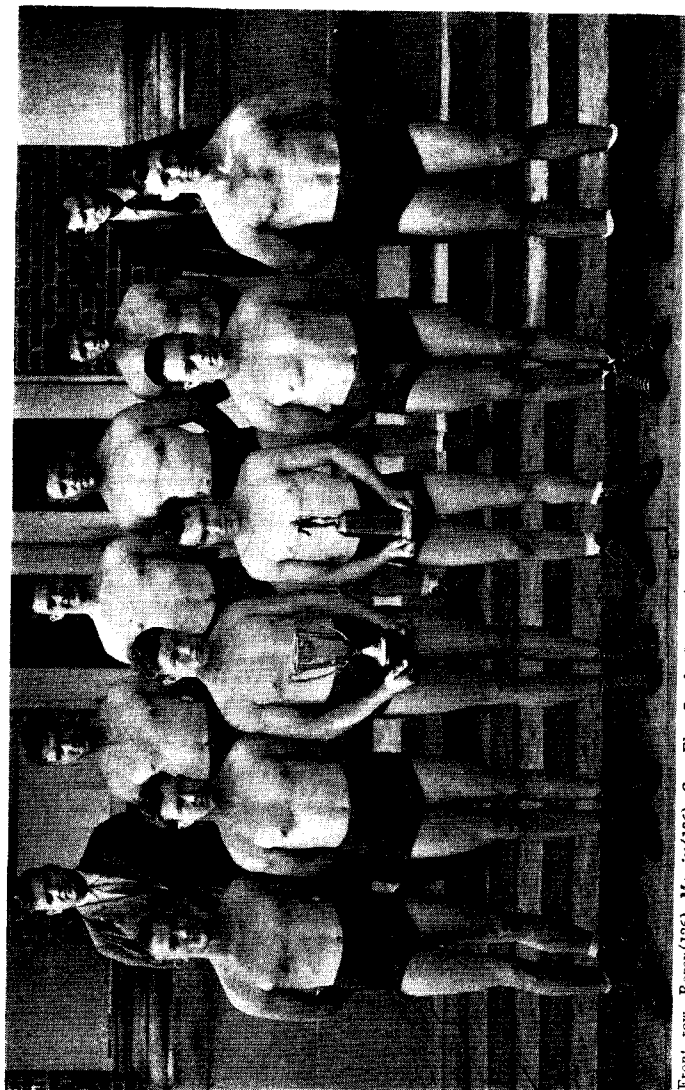

Front row—Borex (126) Merritt (126) Capt. Elect Stanley Henson (145) Joe Mc Daniels (118) Neil (135) Dale Serrivers (153) Back row—Ass. Coach Raymond Swartz Williams (175) Harrell (167) Chiga (167) Harvey Base (165) Coach Ed Gallagher.

OKLAHOMA A. & M. COLLEGE, STILLWATER, OKLA.—NATIONAL COLLEGIATE ATHLETIC ASSOCIATION CHAMPIONS.

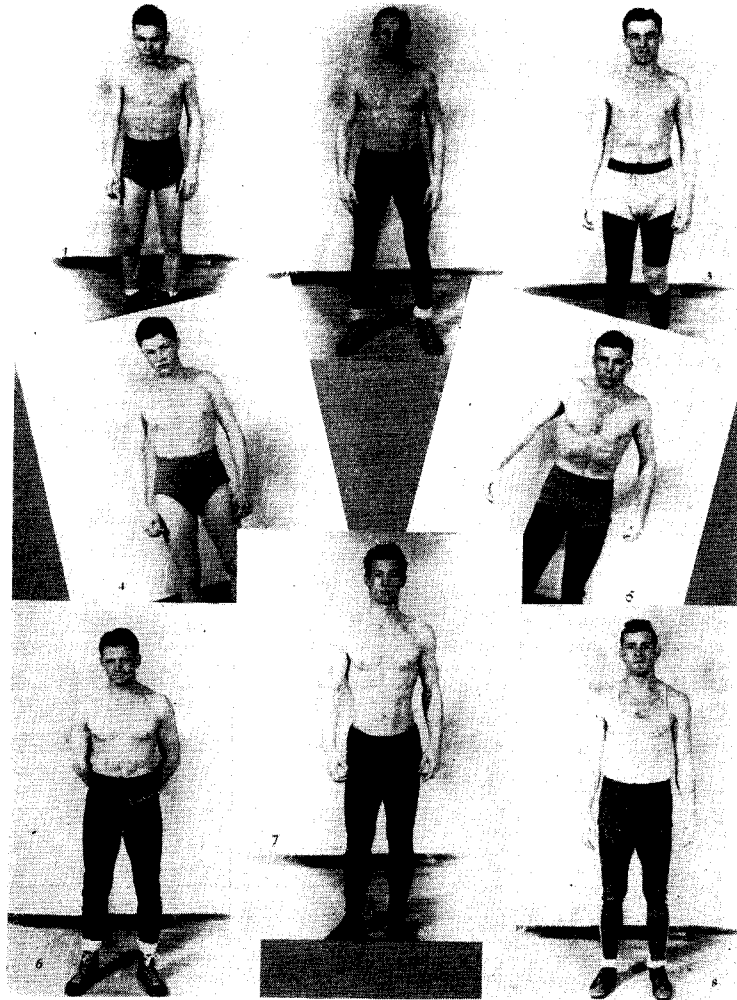

1. Joseph McDaniels (Oklahoma A&M), 118 lbs.; 2. Allen Sapora (University of Illinois), 126 lbs.; 3. David Matthews (University of Oklahoma), 135 lbs.; 4. Stanley Henson (Oklahoma A&M), 145 lbs.; 5. Dale Scrivens (Oklahoma A&M), 155 lbs.; 6. John Ginay (University of Illinois), 165 lbs.; 7. John Harkness (Harvard), 175 lbs.; 8. Charles McDaniel (Indiana University), heavyweight.

NATIONAL COLLEGIATE ATHLETIC ASSOCIATION CHAMPIONSHIP WINNERS.

cameras clicking and the rest of the hall darkened, all added to the impressiveness of the finals.

One thing proved definitely was that the all-night sessions which marred past tournaments are needless in the future if the tournament is held where three mats can be utilized and if it is managed properly. In 1933 three mats were used for the preliminaries, which were completed before eleven o'clock. The finals, followed by all the consolation bouts (three mats), were also completed before eleven.

The Coaches' Trophy for the outstanding wrestler in the tournament was presented to Joseph McDaniels of Oklahoma A.& M., the 118-lb. champion. McDaniels successfully defended his title with ease, outclassing a field of exceptional wrestlers including several sectional champions.

Individual place winners were as follows:

- |   |   |
|---|---|
| <p>118-LB. CLASS.</p> <ol style="list-style-type: none"> <li>1. McDaniels (Oklahoma A&amp;M)</li> <li>2. Duffy (Indiana)</li> <li>3. Natvig (Iowa State Thrs)</li> </ol> <p>126-LB. CLASS.</p> <ol style="list-style-type: none"> <li>1. Sapora (Illinois)</li> <li>2. Murray (Cornell College of Iowa)</li> <li>3. Stone (Oklahoma)</li> </ol> <p>135-LB. CLASS.</p> <ol style="list-style-type: none"> <li>1. Matthews (Oklahoma)</li> <li>2. Deutschman (Illinois)</li> <li>3. Parkey (Oklahoma A&amp;M)</li> </ol> <p>145-LB. CLASS.</p> <ol style="list-style-type: none"> <li>1. Henson (Oklahoma A&amp;M)</li> <li>2. Finwall (Chicago)</li> <li>3. Linn (Iowa State)</li> </ol> | <p>155-LB. CLASS.</p> <ol style="list-style-type: none"> <li>1. Scrivens (Oklahoma A&amp;M)</li> <li>2. Knight (Southwestern Okla Thrs)</li> <li>3. Loucks (Iowa State)</li> </ol> <p>165-LB. CLASS.</p> <ol style="list-style-type: none"> <li>1. Ginay (Illinois)</li> <li>2. Ford (Lehigh)</li> <li>3. Wittenberg (CCNY)</li> </ol> <p>175-LB. CLASS.</p> <ol style="list-style-type: none"> <li>1. Harkness (Harvard)</li> <li>2. Olsen (Southwestern Okla Thrs)</li> <li>3. Traicoff (Indiana)</li> </ol> <p>HEAVYWEIGHT CLASS.</p> <ol style="list-style-type: none"> <li>1. McDaniel (Indiana)</li> <li>2. Gustafson (Minnesota)</li> <li>3. Kygar (Southwestern Okla Thrs)</li> </ol> |
|---|---|

POINTS SCORED BY TEAMS.

	Plmts.	Falls	Tot.		Plmts.	Falls	Tot.
Oklahoma A&M	16	3	19	Chicago	3	1	4
Illinois	13	2	15	Franklin & Marshall	0	3	3
Indiana	9	3	12	Princeton	0	3	3
Southwestern Thr (Okla)	7	1	8	Iowa State	2	1	3
Oklahoma	6	2	8	Iowa State Teachers	1	2	3
Minnesota	3	3	6	City College New York	1	1	2
Lehigh	3	2	5	Nebraska	0	1	1
Harvard	5	0	5	Syracuse	0	1	1
Cornell of Iowa	3	2	5				

# Western Conference (Big Ten)

By Clifford Keen, Coach University of Michigan.

Every college in the Big Ten Conference had a wrestling team in 1938 and each had a complete dual meet schedule. There were three outstanding teams, Illinois, Indiana and Michigan, with all quite evenly matched. The conference championship was decided solely on the basis of points scored in the conference tournament held at Northwestern University. Indiana was undefeated in dual meet competition, but was nosed out by Michigan in the tournament. Points scored toward the team championship were as follows:

### TEAM POINT SCORES.

Michigan	28	Wisconsin	5	Iowa	1
Indiana	25	Minnesota	3	Northwestern	0
Illinois	19	Ohio State	2	Purdue	0
Chicago	5				

In the 118-lb. class John Speicher of Michigan won the title, finally achieving his ambition by defeating Bob Myers of Indiana, defending champion. Myers was second and Dale Hanson of Minnesota third.

In the 126-lb. division Al Sapora of Illinois, defending champion, was defeated by Willard Duffy of Indiana. Sapora won second and Paul Cameron of Michigan was third.

In the 135-lb. division another conference champion lost his title when Earl Thomas of Michigan was defeated by Joe Romar, outstanding Indiana sophomore. Romar was defeated in the finals by Archie Deutschman of Illinois. Deutschman was first, Romar second and Thomas third.

In the 145-lb. division another conference champion was defeated when Bob Finwall of University of Chicago bowed to Lederman of Wisconsin. Lederman was first, Finwall second and Harold Nichols of Michigan third.

In the 155-lb. division Harland Danner of Michigan won the title. Keeler of Indiana was second and Meyer of Ohio State University third.

In the 165-lb. division John Ginay of Illinois was the only champion from 1937 who was successful in protecting his title. Dick Tasch of Michigan was second and Sam Hyde of Indiana third.

In the 175-lb. class Don Nichols, brilliant sophomore from University of Michigan, was first; Traicoff of Indiana was second and Mutter of Illinois third.

In the heavyweight division Joe McDaniels won first, Gustafson of Minnesota, defending champion, was second and Downs from Ohio State third.

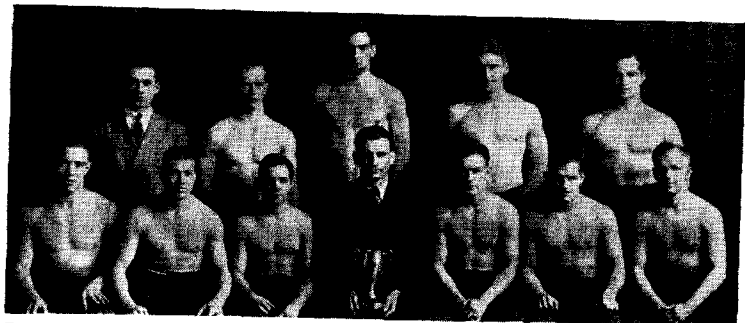

Front row—Dick Tasch Jim Mericka John Speicher(Co-C) Coach Cliff Keen Earl Thomas(Co-C) Harold Nichols Paul Cameron. Back row—Ned Kilmer(M) Harland Danner Joe Savilla Tim Hird Don Nichols. Rentschler, Photo

UNIVERSITY OF MICHIGAN, ANN ARBOR, MICH.

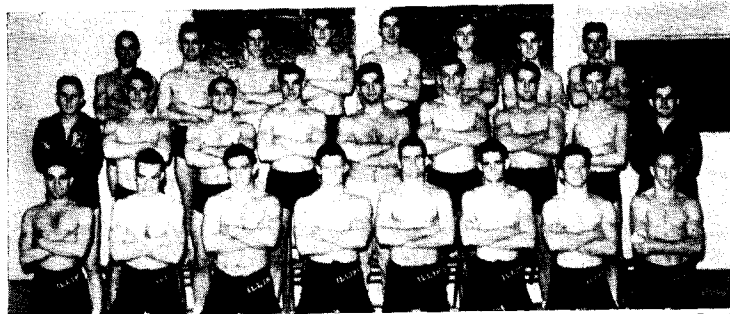

Front row—Helman Boyd Mutter Ginay Lynch Emmons Deutschman Sapora. Row 2—Coach Kenney Price Leeman Brennan Battaglia Huth Leverich Carpenter AsstCoach Law. Back row—Buchman Powless LaRocque Thune Werner Ash George Lutz.

UNIVERSITY OF ILLINOIS, URBANA, ILL.



Front row—Quincannon Rochon Knoll Newbury. Back row—Coach Martin Lederman(C) Piatkiewicz Anderson Merry Andreae(M).

UNIVERSITY OF WISCONSIN, MADISON, WIS.



Front row—Robert Zabel William Culbertson John Matton Earl Steidler Rudie Baack. Back row—Clifton Gustafson(C) Robert Bergen Harold Trahms Lloyd Schumacher Coach Dave Bartelma.

UNIVERSITY OF MINNESOTA, MINNEAPOLIS, MINN.

## Missouri Valley I.C.A.A. (Big Six) Conference

By Paul V. Keen, University of Oklahoma.

Wrestling in the Big Six Conference for 1938 was about on a par with the sport in other years. Kansas University and Missouri University did not have teams, but the other four teams—Iowa State, Kansas State, Nebraska and Oklahoma—completed dual meet schedules and entered full teams in the conference tournament held at Ames, Iowa, March 4 and 5.

In the latter tournament, competition was the closest it has ever been in the ten years the conference has been organized. The championship was decided in the final match. Robertson of Oklahoma won a fall from Clare of Nebraska for third place and the team championship for Oklahoma.

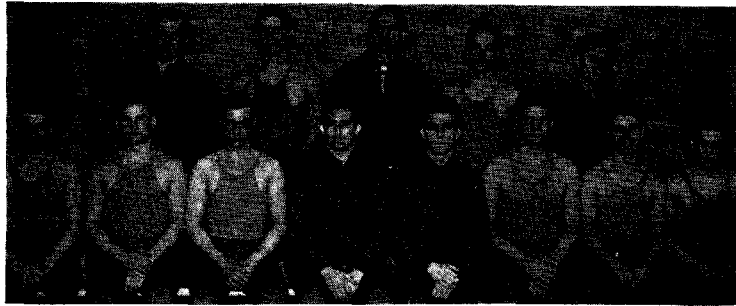

Front row—Tuckey Peltier Jones Boehm(Go-C) Mindlin(Co-C) Downes Hindmarsh Varney.  
Back row—Haugh Hudson Coach Mooney Meyer Terrill.  
OHIO STATE UNIVERSITY, COLUMBUS, OHIO.



Front row—Ektelt Millen Krouse Kingsbury McDowell. Back row—Coach Howard Kemp Vergamini Nead Campbell Williams Smith.  
STATE UNIVERSITY OF IOWA, IOWA CITY.

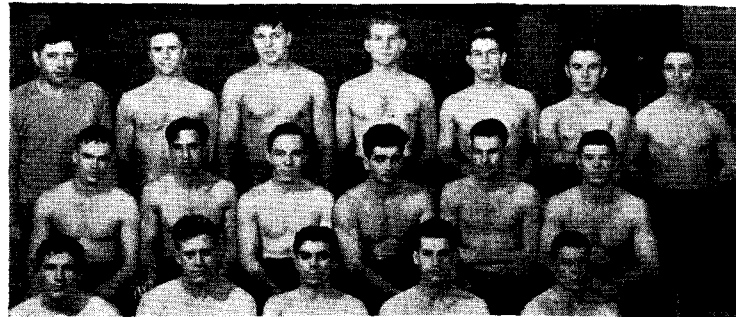

Front row—W.P.Tyrrell J.R.Pratt I.E.Linderman N.C.Gossard S.A.Beem. Row 2—W.H.Dix H.J.Sieber H.L.Timms C.J.Huffman A.W.Dawson A.R.Willy. Back row—Coach Claude Reeck H.V.McKinney A.M.Juska H.K.Larsen A.B.Huston G.Saboff H.A.Berkheiser. Allen & Son,Photo  
PURDUE UNIVERSITY, LAFAYETTE, IND.

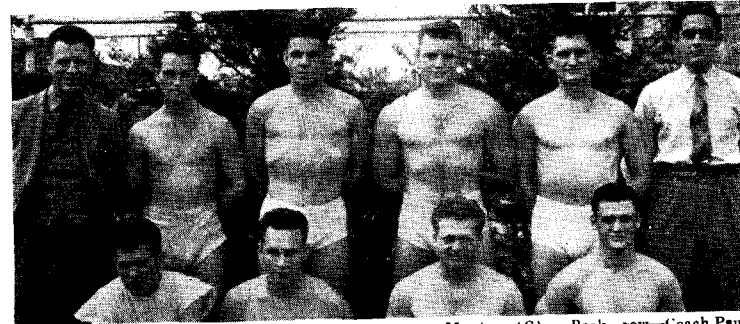

Front row—Dick Adams(lr) Cecil Cross Hoy Stone Matthews(C). Back row—Coach Paul Keen Gene Ross Charlie Robertson Fred Ball Ben Bell Adolph Brown(M). Heffner,Photo  
UNIVERSITY OF OKLAHOMA, NORMAN, OKLA.

### TEAM POINT SCORES.

Oklahoma	25	Iowa State	24
Kansas State	24	Nebraska	5

Previous Winners of Championships—Oklahoma, 1930-32-34-35-36; Iowa State, 1929-33-37; Kansas State, 1931.

Individual championships were evenly divided. Stone of Oklahoma won the 125-lb. class, and his team mates, Matthews and Word, in the 135-lb. and 165-lb. classes, respectively. Linn of Iowa State won the 145-lb. title and Stewart of the same college at 118 lbs. Three men representing Kansas State accounted for victories, VanVleet at 135 lbs.; Reynard, 175 lbs., and Hackney, heavyweight. Matthews of Oklahoma went on to win the N.C.A.A. 135-lb. championship:

## Intercollegiate Wrestling in Oklahoma

By E. C. Gallagher, Oklahoma A.& M. College.

Oklahoma again strengthened its ranking as the nation's No. 1 wrestling state by capturing both national championships. Oklahoma A.& M. College, undefeated in nine dual meet matches for the season, won both the National Collegiate A. A. and National A.A.U. team titles.

University of Oklahoma and Southwestern State Teachers of Weatherford tied for fourth place in team standings at the national intercollegiate. Addi-

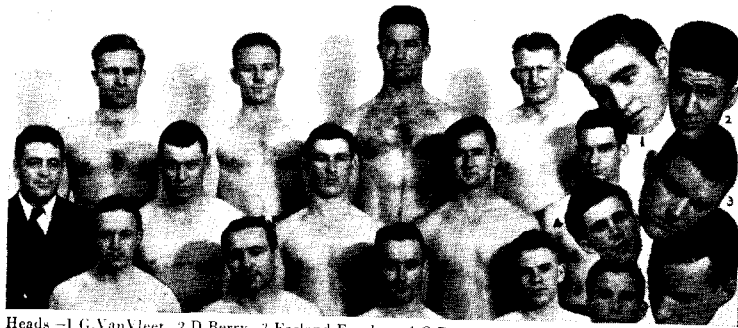

Heads—1 C. VanVleet 2 D. Berry 3 Farland Fansher 4 C. Duncan 5 D. Duncan 6 Forrest Fansher.  
 Front row—J. Payne C. Warner(C) J. Brown T. Beard. Row 2—Coach Patterson K. Norton W. Johnson E. Betz H. Watson. Back row—W. Carleton L. Reynard F. Hackney E. Keller.  
 KANSAS STATE COLLEGE, MANHATTAN, KANSAS.



Front row—Stewart Larson. Row 2—Linn(C) Cutler Cox Kirstein Buckingham. Back row—Coach Hugo Otopalik Loucks Henderson Stoecker Buck Rowe(M).  
 IOWA STATE COLLEGE, AMES, IOWA.

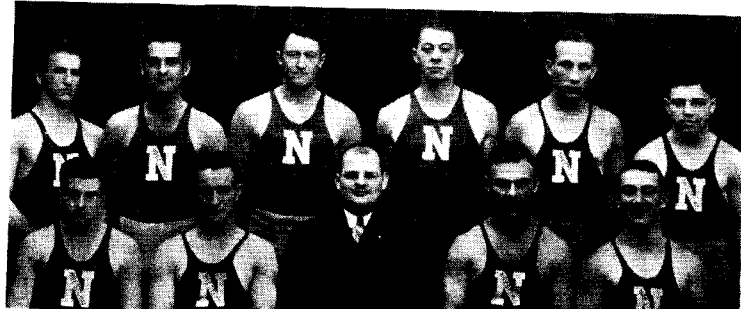

Front row—Webster Knight Coach Jerry Adam Johnson Luke. Back row—Miegel Tomes Fidler Adam Marsh Clare.  
 UNIVERSITY OF NEBRASKA, LINCOLN, NEB.

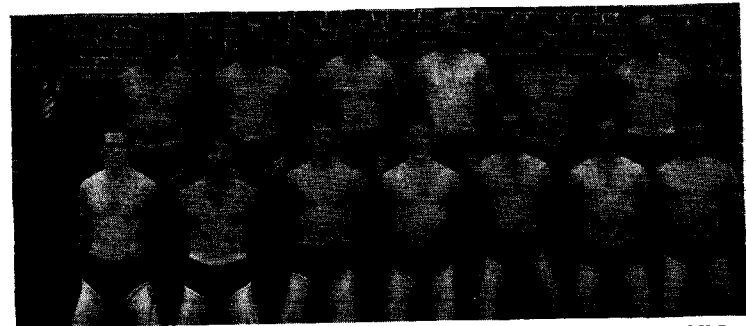

Front row—Knight Bogle Peck Renfro(C) Martin Lawley Engle. Back row—Coach M.H. Surbeck Kygar Caves Olson Smith Tyszkowski Cooper.

WEATHERFORD (OKLA.) TEACHERS COLLEGE.

tional state honors included the championship of the annual Big Six Conference tournament, won by Oklahoma University.

Within the state, A. & M. regained its state college league championship, relinquished for the first time to Southwestern a year previously. A. & M. was the state's only unbeaten team and gained permanent possession of the Sam Avey trophy for winning three state team titles since the cup was first offered.

Southwestern, defending league champion, was runner-up to A. & M. last season and won the state teachers college conference championship for 1938. Oklahoma University finished third in the state league, nosing out Central State Teachers of Edmond by a surprising win in the final league match of the year.

Final standings in the state college league for 1938:

Teams.	Won.	Lost.	Tie.	PC.	Teams.	Won.	Lost.	Tie.	PC.
Oklahoma A. & M.	7	0	0	1.000	Central Thrs.	2	4	0	.333
Southwestern Thrs.	3	2	1	*.583	Northeastern Thrs.	0	4	0	.000
Oklahoma University	2	4	1	*.384					

\*Tie figured half-match won, half-match lost.

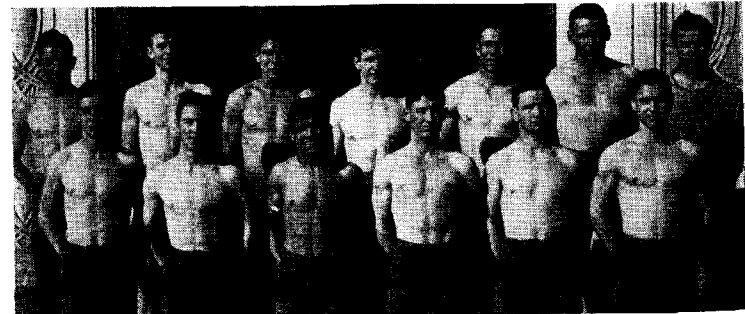

Front row—Hart Wright Villa Real Devine Anderson Hill. Back row—Allen Manning Juby Barnett Taylor Thompson Coach Smith.

EDMOND (OKLA.) TEACHERS COLLEGE.

## Eastern Intercollegiate Championships

By William Sheridan, Coach Lehigh University.

The thirty-fifth annual Eastern Intercollegiate Wrestling Association championships were held at Cornell University, March 11 and 12, 1933, and once more the intense rivalry of the league resulted in some exceptionally keen battles for individual honors.

The team title was won by Lehigh by a margin of two points over Princeton, an almost exact duplicate of the meet held at Princeton two years previously. The ultimate winner of the championship was not determined until the final third-place matches were completed, so that the interest of spectators and competitors alike was at a high pitch until the last decision was rendered.

Lehigh and Princeton each had three individual champions, Harvard had one and Cornell one. John C. Harkness of Harvard, winner of the title in the 175-lb. division, was the recipient of the trophy awarded to the "outstanding wrestler of the tournament." Harkness was also winner of the 175-lb. national championship title in the National Collegiate A.A. championships at Penn State College two weeks later.

The Eastern Intercollegiate tournament is the oldest wrestling tournament in the country and each year the interest of spectators and competitors seems to be on the increase.

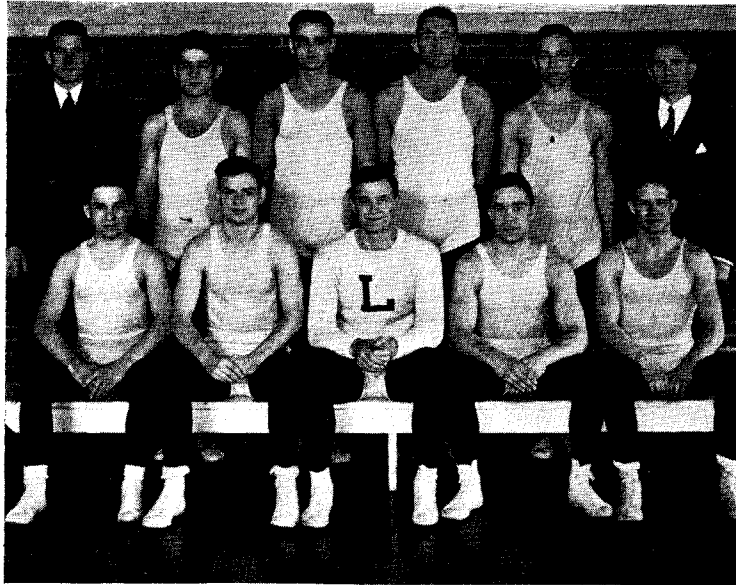

Front row—Walter Allen Stone Richard Bishop(C) Masem Burnett. Back row—Young(M) Small Curtis Ford Sterngold Edward Hagerman Coach William Sheridan. McCas, Photo

LEHIGH UNIVERSITY—EASTERN INTERCOLLEGIATE CHAMPIONS.

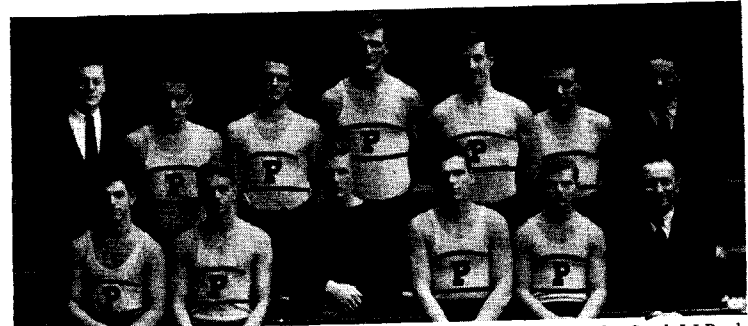

Front row—Carl Elkan R.B.Harding M.S.Emory(C) C.A.Powers A.Y.Foshay Jr. Coach J.J.Reed. Back row—N.M.Stahl(M) F.W.Capers A.J.Barzaghi C.H.Toll Jr. R.H.Smith F.C.Field Jr. Edward Zanfrini(Tr). OrrenJackTurner,Photo

PRINCETON UNIVERSITY, PRINCETON, N. J.

### TEAM POINT SCORES EASTERN INTERCOLLEGIATE CHAMPIONSHIPS.

Lehigh .....	25	Penn State .....	11	Harvard .....	*2
Princeton .....	23	Cornell .....	7	Syracuse .....	2
Yale .....	18	Pennsylvania .....	4	Columbia .....	0

\*Harvard penalized 5 points for one man short of full team.

Following is a summary of first, second and third place winners:

118 lbs.—Mathas (Cornell), won; Allman (Pennsylvania), second; Burnett (Lehigh), third. 126 lbs.—Harding (Princeton), won; Craighead (Penn State), second; Hamman (Yale), third. 135 lbs.—Masem (Lehigh), won; Bird (Yale), second; Reynolds (Penn State), third. 145 lbs.—Hagerman (Lehigh), won; Capers (Princeton), second; Gerber (Yale), third. 155 lbs.—Powers (Princeton), won; Bird (Yale), second; Trousdell (Cornell), third. 165 lbs.—Ford (Lehigh), won; Woodland (Yale), second; Daughaday (Harvard), third. 175 lbs.—Harkness (Harvard), won; Shaffer (Penn State), second; Small (Lehigh), third. Heavyweight—Toll (Princeton), won; Pickett (Yale), second; Sterngoid (Lehigh), third.

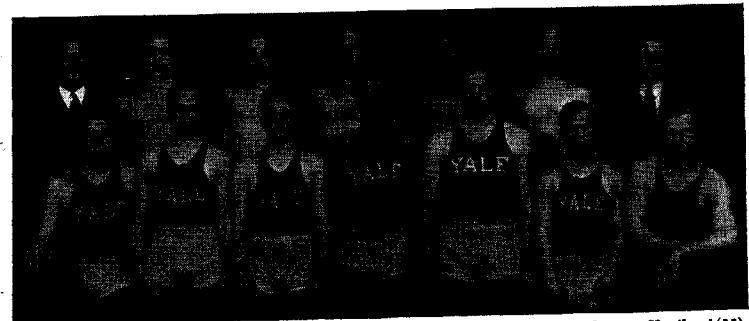

Front row—Clark Hatman W.Bird Woodland(C) Pickett Mallin Cutler. Back row: Haviland(M) Mann Ely Gerber Jopling J.Bird Brightwell.

YALE UNIVERSITY, NEW HAVEN, CONN.





Front row—Coach Speidel Bachman Shaffer Zazzi Jardin(M). Back row—F.Craighead Reynolds Bortz Priolo King J.Craighead.

PENN STATE COLLEGE, STATE COLLEGE, PA.

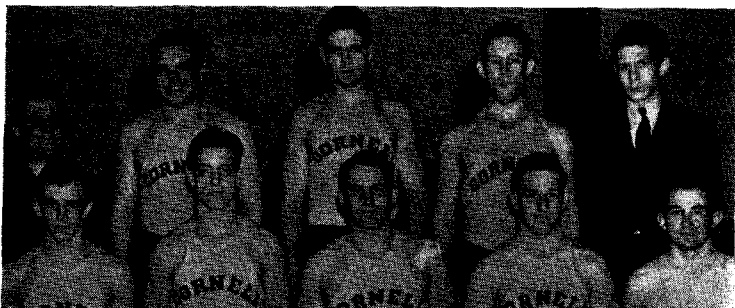

Front row Mathas Oaks Kiehle Kuchler Blackmore. Back row—Coach Walt O'Connell Jeannopoulos Leavitt Trousdell Fred Lourie(M).

CORNELL UNIVERSITY, ITHACA, N.Y.



Front row—Coach W.Austin Bishop Norman Bond Calvin Hollis Ben Ruggiero(C) William Hill Robert Allman AsstCoach Eugene L.Jenness. Back row—John Brennan(Ty) Morgan Berthrong William McKee Richard Miller Philip Voorhees John Maleno William Long Joseph Sataloff Richard Creighton(M).

UNIVERSITY OF PENNSYLVANIA, PHILADELPHIA, PA.



Front row—Daughaday Ross Harkness Ach Pope. Back row—Coach Pat O.Johnson Gosline Glendinning Barnes Bart(M). Notman,Photo

HARVARD UNIVERSITY, CAMBRIDGE, MASS.



Front row—Fred Jenner Karl Metz Willard Wilder Edwin Cubby(M) Roy Gertmenian Coach William J.Davison Enrico Williams Charles Theroux. Row 2—Thomas Carter Clarence Patten Harold Symons Eugene Wilson Arthur Becker John Rogers Stan Moduszewski Burt Bryant Abe Rosenberg. Back row—John Mathieson George Hooper R.A.Hemingway Robert Armstrong Howard Peters(C) Reuben Keppel Porter Sheldon Robert Woodard.

SYRACUSE UNIVERSITY, SYRACUSE, N.Y.



Front row—Victor Bucci Frank Cerzosimo. Row 2—Harold Zaret Robert Booth Robert Taylor(C) James Frost Charles Holt. Row 3—Lenox Muldoon Joseph Bartolf Cloyd Snavely Andrew Jochum. Back row—John Alexander Robert Minervini(M) Coach Gus Peterson AsstCoach Richard Waite.

COLUMBIA UNIVERSITY, NEW YORK CITY.

# Southern Conference

By H. M. Read, Virginia Military Institute.

## WRESTLING IN DISTRICT III

Intercollegiate wrestling in District III continued to be supported by about twenty teams, seven of which are members of the Southern Conference, with a membership of fifteen institutions. Interest from the Mississippi River up through Maryland is chiefly centered in the States of Virginia and North Carolina. The revival of the Southern Conference tournament aid much to encourage the sport in conference territory. Held under the auspices of Virginia Polytechnic Institute, March 4 and 5, 1938, the sixth annual tournament was won by Virginia Military Institute with a team score of 32 points. Washington and Lee, with 29 points, was runner-up, reversing the 1936 result when Washington and Lee nosed out V.M.I., 33 to 30. No tournament was held in 1937.

The V.M.I. Cadets dominated the championships in the individual classes, crowning four titleholders and scoring three second places and one third place. Seven teams were entered, but North Carolina State College wrestlers were forced to withdraw because of term examinations. The State team won six of seven dual meets, losing only to Washington and Lee.

In meets with strong teams outside the conference, the members of the conference made much better showings than some of the dual meet scores would indicate.

Results of the Southern Conference championships were as follows:

### TEAM SCORES.

Virginia Military Institute.....	32	Davidson .....	7
Washington and Lee.....	29	Virginia Polytechnic Institute.....	5
North Carolina .....	7	Duke .....	1

**118 lbs.**—Kemp (W&L), won; Strate (VMI), second; Harris (North Carolina), third. **126 lbs.**—Foust (VMI), won; Pittman (VPI), second; Eaton (W&L), third. **135 lbs.**—Reeves (VMI), won; Broome (W&L), second; Craver (Davidson), third. **145 lbs.**—Pitts (North Carolina), won; Nielson (W&L), second; Talman (VMI), third. **155 lbs.**—Thomas (W&L), won; Hill (VMI), second; Summerville (Duke), third. **165 lbs.**—Steidtmann (VMI), won; Farrier (W&L), second; King (VPI), third. **175 lbs.**—Martin (VMI), won; Braun (W&L), second; Tsurounis (VPI), third. **Unlimited**—H. McFayden (Davidson), won; Fiedler (VMI), second; Lykes (W&L), third.



Front row—Coach Mathis Kemp Bosmaa Eaton Nielsen Thomas Farrier Braun Lykes Broders(M). Back row—Mehler Crane Summerall McInerney Broome Hillier Parkey Alford Buxton Bowles. WASHINGTON AND LEE UNIVERSITY, LEXINGTON, VA.



Front row—L.S.Reynolds N.J.Kless C.R.Chandler R.E.Mason A.Minsville H.Player(C) R.F.DuBois E.F.Conrad C.F. Leigh W.C.Shaffer Jr. F.W.Silk. Row 2—Lt.Cdr.W.F.Fitzgerald(Off Rep) G.A.Wolf A.B.Ostroski J.S.Claypoole W.L.Lamb J.B.Mitty T.H.Laylor R.T.Bailey R.D.Mugg D.K.Mitchell G.H.Abel G.Gould J.P.Rossie O.W.Bagby(M) Coach John Schatz. Back row—H.Palmer J.C.Harr H.F.Wells J.P.Arrezo J.C.H.Smith M.E.Kerns T.S.Sutherland H.Spector R.F.Smith J.M.Reigart J.M.Schaser H.M.Born in U.S.

UNITED STATES NAVAL ACADEMY, ANNAPOLIS, MD.



Front row—Strate Kandel Foust Reeves Talman Steidtmann(C) Hill Martin Wasdell Bickford. Back row—Coach Barnes Chapman Jeffrey Matter West Booth Bayless Dudley Opie Hoge Minns McGuire(M).

VIRGINIA MILITARY INSTITUTE, LEXINGTON, VA.





Front row—Pitts Davison Zink Tankersly Harriss James. Row 2—Faireloth Patrick Davis Morgan Joyner. Back row—Coach Quinlan Peterson(M) Woodson Clements Strickler Sunstein(M).

UNIVERSITY OF NORTH CAROLINA, CHAPEL HILL, N.C.

#### DUAL MEET RECORDS, DISTRICT III.

##### Davidson College, Davidson, N.C.

14—Winston YMCA 16      11—North Carolina 21      14—No Carolina State 16  
24—Duke 8              3—Washington & Lee 27      13½—Va Mil Inst 14½  
6—Va Poly Inst 18

##### University of North Carolina, Chapel Hill.

11—Va Poly Inst 17      4½—Wash & Lee 23½      31—Duke 3  
11—Navy 21              21—Davidson 11              11—No Carolina State 21

##### Virginia Military Institute, Lexington

1½—Lehigh 30½      16½—Va Poly Inst 7½      9—Kansas State 19  
15½—Navy 12½      0—Indiana Univ 26              14½—Davidson 13½

##### Washington and Lee University, Lexington, Va.

22—No Carolina State 8      11—Princeton 23              8—Kansas State 18  
23½—North Carolina 4½      27—Davidson 3              25—Va Poly Inst 3

##### Duke University, Durham, N.C.

8—Davidson 24              0—No Carolina State 32      3—North Carolina 31  
8—Norfolk YMCA 28

##### North Carolina State College, Raleigh.

8—Washington & Lee 22      35—Tennessee 3              16—Davidson 14  
19—Va Poly Inst 9              32—Duke 0                      21—North Carolina 11  
23½—Maryville 4½

##### Virginia Polytechnic Institute, Blacksburg.

17—North Carolina 11      7½—Va Mil Inst 16½      3—Washington & Lee 25  
19—No Carolina State 9      18—Davidson 6

##### United States Naval Academy, Annapolis, Md.

12½—Va Mil Inst 15½      6—Indiana Univ. 22              24½—Pennsylvania 9½  
21—North Carolina 11      20—Harvard 8                  9—Penn State 17  
4½—Lehigh 25½

The United States Naval Academy is not a member of the Southern Conference; other teams listed are members.

Dual meet records were not received from following schools supporting wrestling in District III (repeated requests were made): Appalachian State Teachers College, Cumberland University, Maryville College, Johns Hopkins University, University of Miami, University of Tennessee, Vanderbilt University.

## Intercollegiate Wrestling in the Rocky Mountain Region

By John W. Hancock, Greeley State College.

Interest and participation in intercollegiate wrestling in the Rocky Mountain region is greater than ever before. Reports from nearly every college indicate that there are more men out for wrestling now than at any time in the past.

Intercollegiate wrestling in the Rocky Mountain region consists of two groups—the Mountain States Conference (Big Seven) and the Rocky Mountain Conference. The Mountain States Conference is divided into Eastern and Western divisions. Eastern Division schools are: Colorado University, Wyoming University, Denver University and Colorado State. Western Division schools comprise: Utah University, Utah State and Brigham Young University. Utah State won

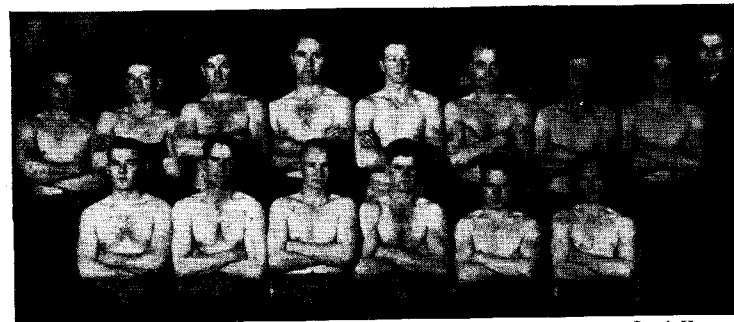

Front row—Tucker Wedemeyer Blake Godley Martin Conant. Back row—Coach Hancock Heinze Bohlander Slack TeMaat Provart Klein MacBeth Miller AsstCoach Rose.

GREELEY (COLO.) TEACHERS COLLEGE.

the Western Division championship and Colorado University won the Eastern Division honors.

Five schools form the Rocky Mountain Conference: Montana State College, Western State College, Colorado College, Colorado Mines and Greeley State. The wrestling title in this conference last season ended in a tie, with Western State and Greeley State as co-champions.

Individual champions in the Rocky Mountain Conference and Mountain States Conference (Eastern Division) are as follows:

Mountain States.		Rocky Mountain.	
118 lbs.—Adachi (Wyoming)		118 lbs.—Dickinson (Colorado Mines)	
126 lbs.—McKee (Denver)		126 lbs.—Martin (Greeley State)	
135 lbs.—Fischel (Colorado)		135 lbs.—Miller (Greeley State)	
145 lbs.—Herzberger (Colorado State)		145 lbs.—Morris (Western State)	
155 lbs.—Sibley (Colorado)		155 lbs.—Turner (Greeley State)	
165 lbs.—Garlitz (Colorado State)		165 lbs.—Provart (Western State)	
175 lbs.—Devet (Colorado State)		175 lbs.—Thompson (Western State)	
Heavyweight—Woudenburg (Denver)		Heavyweight—Otto (Western State)	

## Mountain States Athletic Conference

By Pete Couch, Coach University of Utah.

Athletic officials as well as wrestling coaches in the Western Division of the Mountain Athletic Conference were greatly encouraged with the added interest shown the past year.

Competition is becoming so keen that only three points separated the title-winning Utah State College and the third place Utah University team, Brigham Young University finishing second.

Utah University, four-time conference winners were forced to relinquish their title to one of the best balanced teams ever to represent Utah State College.

Individual titles were well distributed, Utah University winning in the 145-lb., 175-lb. and heavyweight divisions. Utah State College won the 118, 126 and 165-lb. classes, while B.Y.U. carried off honors in 135 and 155-lb. events.

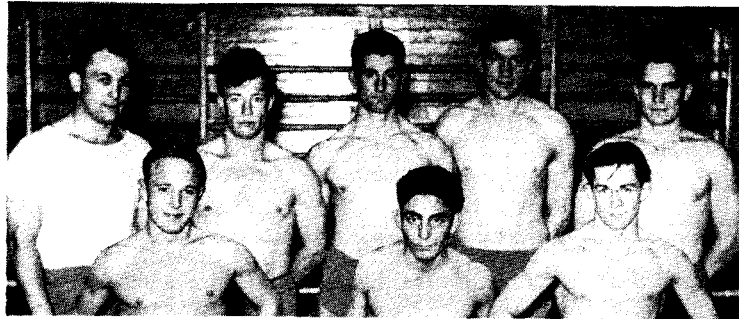

Front row—Fischel Ortiz McNeill. Back row—Coach Sayre Thompson Rubright Dow Sibley.  
UNIVERSITY OF COLORADO, BOULDER, COLO.



Front row—Spishakoff Stone Fox Grenard Herzberger Hollar. Row 2—Glass Spradlin Fritchman Garlitz Thuelin Good. Back row—Coach Wagner Hall Devet Kinchelov Theos Rooney.  
COLORADO STATE COLLEGE, FORT COLLINS, COLO.

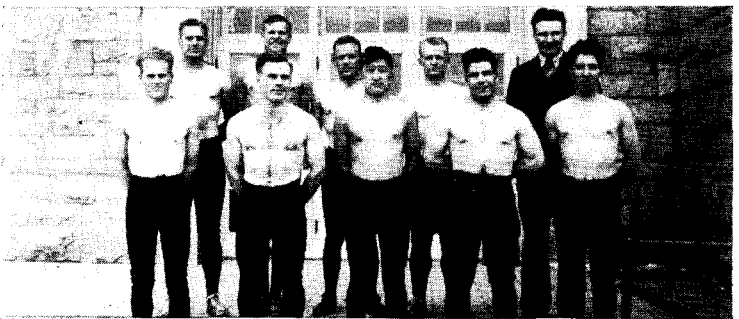

Front row—Lieberman Bruner Adachi Bertagnolli Sandoval. Back row—Nipper Wibel Bjorn Hart Coach Lantz.  
UNIVERSITY OF WYOMING, LARAMIE, WYO.

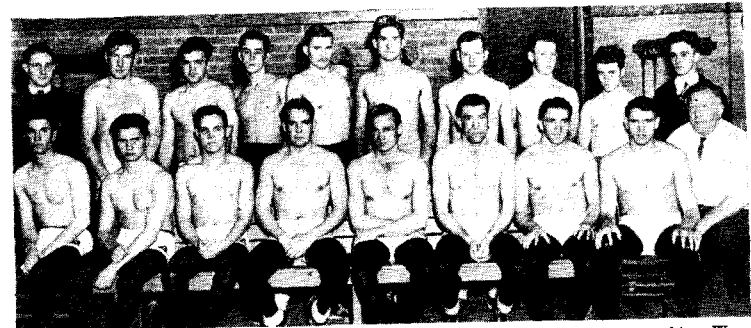

Front row—Darwin Perkins DeWitt Grandy Rollo Larsen David Greene Douglas Perkins Wendell Twitchell Ace Roundy Sherm Gold Coach George Nelson. Back row—LaVan Hendricks (M) Parley Young Crosby Bott Don Erickson Velt Erickson Frank Bringham Harold Serale Sam Hilton Grant Johnson Jay Bingham (M).

UTAH STATE COLLEGE, LOGAN, UTAH.

It is hoped that within the next year or two a regular Mountain States Conference meet will be held in which the seven schools will compete for conference honors rather than having an Eastern and a Western division.

In the final standing of the Western Division meet, held at Utah State College, Logan, Utah State won with 31 points, B.Y.U. was second with 30, and Utah University with 28. Individual title winners were as follows:

- |                               |                                |
|-------------------------------|--------------------------------|
| 118 lbs.—Bench (Utah State).  | 155 lbs.—Hullinger (BYU).      |
| 126 lbs.—Grandy (Utah State). | 165 lbs.—Roundy (Utah State).  |
| 135 lbs.—Lewis (BYU).         | 175 lbs.—Armantrout (Utah).    |
| 145 lbs.—Banks (Utah).        | Heavyweight—Schleckman (Utah). |

Utah State also won the state title by defeating both Utah and B.Y.U. In dual competition Utah defeated B.Y.U.

The Utah State High School Association held a state wrestling meet for the first time last season. This should add considerable interest to the already popular college sport.

## Intercollegiate Wrestling on Pacific Coast

By Henry A. Stone, University of California.

Wrestling is showing a slow but steady growth in the Northern Division of the Conference. Last season a few non-Conference colleges added wrestling to their athletic program. The University of Idaho was undefeated in dual competition. Washington, Montana and Washington State College all lost to the Vandal matmen, but in a return engagement Washington State held them to a tie. The Northern Division championships were held at Seattle on March 12, 1938. The best Idaho, defending champion, could do was third, behind Washington State and University of Washington, who tied for first place. The Northern Division produced outstanding men in Kawahara (Washington), Huntington (Idaho) and Semanek (Washington State College).

Individual championships were distributed as follows:

118 lbs.—Eamon (Washington State). 126 lbs.—Kawahara (Washington).  
135 lbs.—Macy (Idaho). 145 lbs.—Huntington (Idaho). 155 lbs.—Truscott (Washington).  
165 lbs.—Tschantz (Washington State). 175 lbs.—Arwood (Washington).  
Heavyweight—Semanek (Washington State).

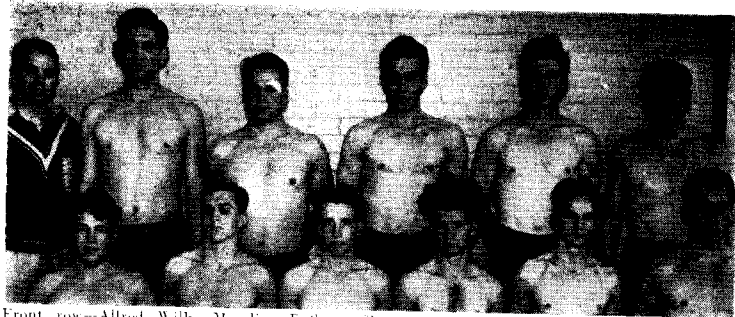

Front row—Alfred Wilks, Marahus, Fullmer, Slaughter, Banks. Back row—Coach Pete Couch, Schreckman, Armantrout, Stirk, McCloy, Hess (C).

UNIVERSITY OF UTAH, SALT LAKE CITY.



1 Chris Mortensen 2 Jack Stringham 3 Ronald Jeffery 4 Eddie Allen 5 Max Bateman 6 Lawrence Golding 7 Robert Tschert 8 Orville Hollinger 9 Ronald Larsen 10 Gerald Gillespi 11 LeGrande Lewis (C) 12 Coach Neff Smart.

BRIGHAM YOUNG UNIVERSITY, PROVO, UTAH.

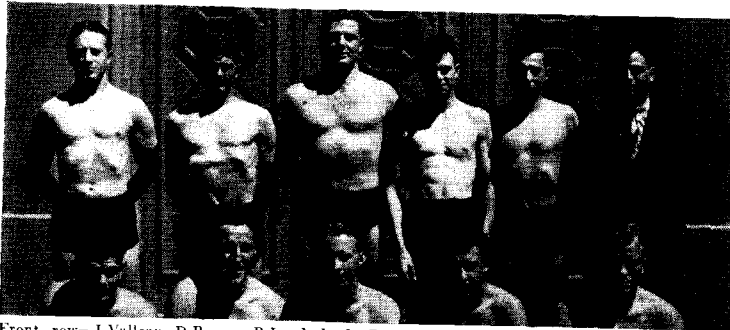

Front row—J. Valleau, D. Berger, B. Lauderbach, B. Dake, D. Peterson. Back row—F. Roberts, H. Schaffer, W. Williams, C. Francis, M. Meyers, Coach Alvan Bogue.

UNIVERSITY OF OREGON, EUGENE, ORE.



Front row—Arnold Dillard, Bill Tschantz, Bob Christensen, Don Peters, Dean Cooper, James Eamon. Back row—Coach Robert S. Neilson, Bob Wilcoxon, Newell Groves, Charles Semanek (C), Frank Bratonia, Joe Riker, Dr. Wilbur H. S. Bohm, Hutchison, Photo

WASHINGTON STATE COLLEGE, PULLMAN, WASH.

In the Southern Division the season was a great success. There is more interest than ever before. University of Nevada and Whittier College have added wrestling to their list of competitive sports. San Jose State College was undefeated in all their dual meets. University of California, after dropping their first meet of the season to San Jose, completed the remainder of the season with a clear record. The conference championships were held at Berkeley, April 7 and 8, 1938. University of California won its tenth consecutive championship, scoring 42 points. The conference championships were held at Berkeley, April 7 and 8, 1938. University of California won its tenth consecutive championship, scoring 42 points. San Jose State was second, with 29; University of California at Los Angeles was third, with 21, and Nevada fourth, with 5. Other entrants failed to score. Outstanding performers were Dalo (California) and Kerfoot (UCLA). Results:

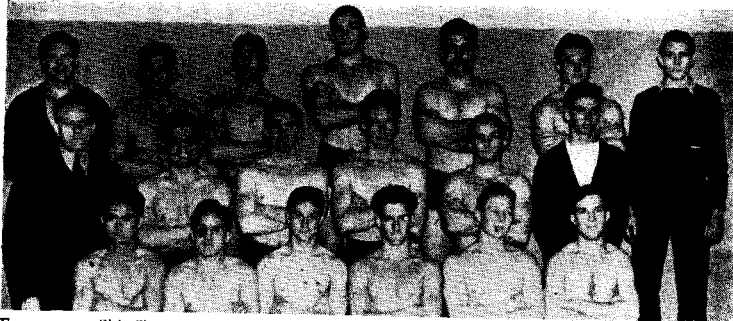

Front row—Chic Tonouye Jack Fiebig Keith Hughes Martin Olavarri(C) Hugo Pink Clifford Horn. Row 2—Coach Eugene B.Grattan Gabriel Velez Carlton Lindgren Melvin Rush George Wenglein Leroy Hill(AM). Back row—Willard LeCrov(M) Robert Riddle Joe Reginato John Jones Sam DellaMaggiore Jack Smith John Holtorf(AM).

#### SAN JOSE (CALIF.) STATE COLLEGE.

118 lbs.—Masaki (UCLA), won; Fujioka (California), second; Janoye (San Jose), third. 126 lbs.—Dato (California), won; Hughes (San Jose), second; Thomas (UCLA), third. 135 lbs.—Funk (California), won; Kulhan (Nevada), second; Woolsey (UCLA), third. 145 lbs.—Kerfoot (UCLA), won; Watt (California), second; Huebner (Nevada), third. 155 lbs.—Winglein (San Jose), won; Enos (California), second; Moore (Nevada), third. 165 lbs.—Rush (San Jose), won; Benson (California), second; Sellars (UCLA), third. 175 lbs.—Shepard (California), won; Smith (San Jose), second; Roberts (UCLA), third. **Heavyweight**—Jones (San Jose), won; Spear (California), second; Jones (UCLA), third.

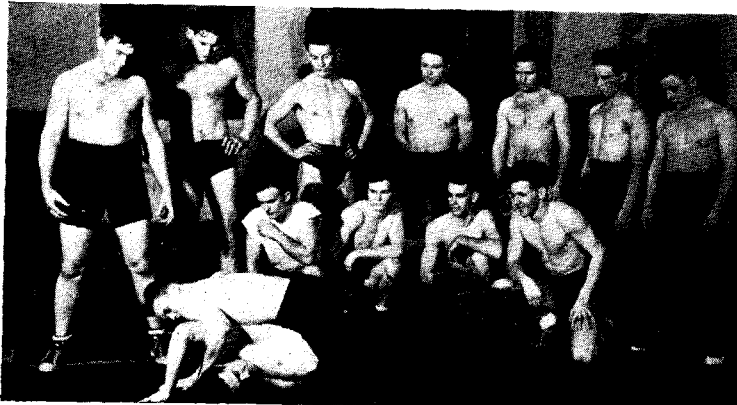

On mat—Mike Nelson(top) Jack Smith. Front row—Harold Elg Joe Mills Clarence Kassens Bert Huntington(C). Back row—Stonko Pavkov Forrest Ober Dennis Hess Dee Fjeldstead Corlys Hubbard Noel Hallett William Barrett.

#### UNIVERSITY OF IDAHO, MOSCOW, IDAHO.

## Wrestling in California Junior Colleges

By Alvin Stonehocker, Fullerton Junior College.

The past two years have been marked by a great increase in interest and participation in wrestling in California junior colleges. In Northern California, Modesto Junior College and San Mateo Junior College have both been represented in competition, scheduling high schools and college freshman teams. In the southern part of the state Fullerton Junior College has had a successful season.

Fifty boys reported to Coach Alvin Stonehocker at Fullerton Junior College last season. Their dual meet schedule consisted of eight meets. In junior college competition they remained undefeated for the second year and were beaten only by a narrow margin by San Jose State and Whittier.

Los Angeles Junior College continued its 1938 wrestling season under the direction of Coach Milton Hand. They are members of the S.P.A.A.U. Wrestling League, which has a dual schedule consisting of eight dual meets. In this still competition they were unable to place very high. However, they took first in the S.P.A.A.U. Novice Tournament, with one first and three seconds, to gain a net total of 14 points.

Santa Monica Junior College, under its new coach, James Crossman, entered a full team in the Southern California Junior College Association tournament. This is an increase over the previous year, showing that wrestling has become more popular at that institution. Although their point tally in the tournament was small, their squad showed a definite improvement in both wrestling ability and competitive spirit. Intramural wrestling constituted their main events and no dual meets were scheduled. This year they hope to enter in a regular dual schedule with other junior colleges in the Southern California section.

The second annual Southern California Junior College championships were held at Fullerton, May 6, 1938. A total of forty-two entries were received. Fullerton J.C. won, with 55 points; Los Angeles J.C. was second, with 38 points, and Santa Monica J.C. third, with 6 points. Individual winners were as follows:

112 lbs.—Norte (LAJC). 118 lbs.—Ymuchi (LAJC). 126 lbs.—Glasheen (FJC). 135 lbs.—Blue (LAJC). 145 lbs.—Barels (FJC). 155 lbs.—Cummins (FJC). 165 lbs.—White (FJC). 175 lbs.—Winters (FJC). **Heavyweight**—Chantiles (FJC).



Front row—T.Imoto K.Oviatt R.Barels H.Cummins T.Chantiles E.White T.Glasheen. Row 2—Coach O.Stonehocker N.Tashima H.Messamer E.Gagnon R.Young D.Davis R.Law D.Adams. Back row—B.Ainsworth G.Nugent B.Beauchamp G.Madge J.Ryan L.Richardson P.Hildebrand.

#### FULLERTON (CALIF.) JUNIOR COLLEGE.

## "Little Three" Championships

The first "Little Three"—Amherst, Wesleyan and Williams—wrestling championship tournament was held at Wesleyan University, Middletown, Conn., March 5, 1938, and produced close and interesting competition. Williams won, with 30 points; Wesleyan was second, with 26 points, and Amherst third, with 23 points. Gold medals were awarded to individual class winners listed here-with:

118 lbs.—Jones (Williams), 126 lbs.—Handyside (Amherst), 135 lbs.—Minnick (Amherst), 145 lbs.—Esterbrook (Wesleyan), 155 lbs.—Dorsey (Williams), 165 lbs.—Petherbridge (Wesleyan), 175 lbs.—Eldaer (Williams). Un-limited—Tenny (Williams).

While no New England tournament was held last season the teams of the conference nevertheless participated in full dual meet schedules, Yale being the only one to remain undefeated. Many fine wrestlers were in evidence, especially among freshmen teams. It is hoped that the conference meet will be resumed this year.



Front row—J.Cranshaw B.Minnick R.Benedict D.Minnick(C) A.Miller S.Handyside G.Bartlett. Back row—A.Davis(AM) R.Buehler(M) R.Harding H.Whitten J.Ruthenberg Coach C.Soleau.  
AMHERST (MASS.) COLLEGE. Photo Shop

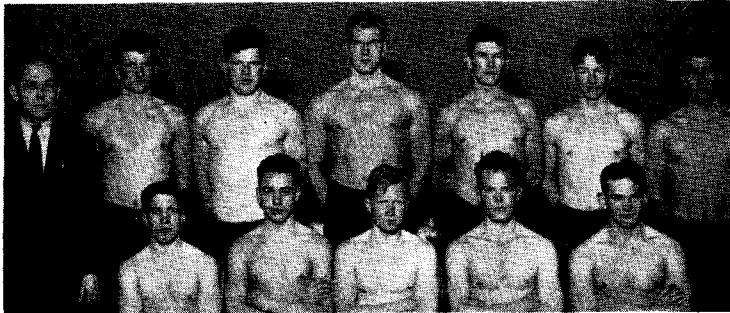

Front row—C.Baker Renhault J.Watson W.Garney L.JaPalme. Back row—U.Koskela(M) C.Walbridge R.Sherry R.Herman J.Colleton R.Spencer J.Sweeney.  
TUFTS COLLEGE, MEDFORD, MASS.

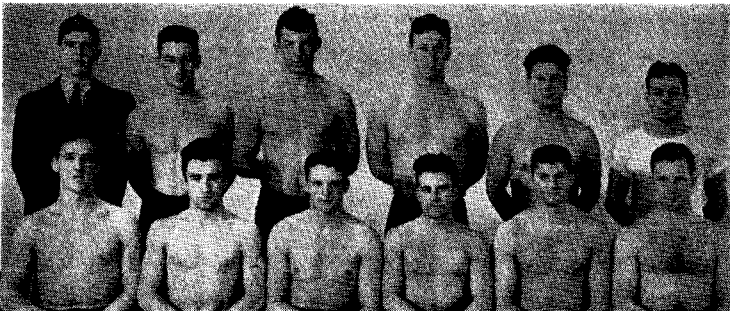

Front row—Keller Cain Senechal(C) Childs Baldwin King. Back row—Tubman(M) TenHaagen Nast Chase Lathrop Coach Cole.  
BROWN UNIVERSITY, PROVIDENCE, R.I. C.G.Rice,Photo.

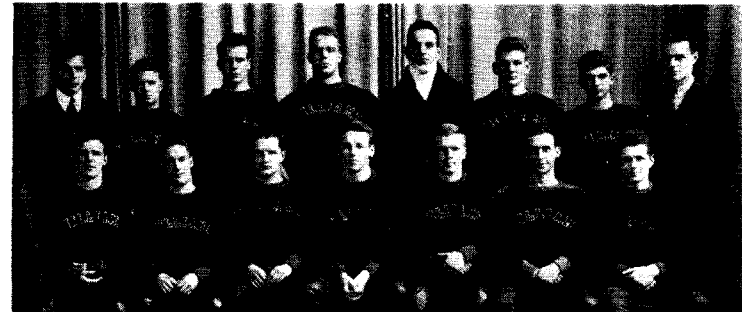

Front row—A.K.Wheelock O.E.Jones R.H.Andre W.R.Comfort(C) W.W.Brown H.C.Fett W.W.Eldaer. Back row—W.J.Agate(M) K.S.Klages W.G.Hayward M.A.Tenny J.W.Morse H.L.Potter M.Busch B.S.Witkower(AM).

WILLIAMS COLLEGE, WILLIAMSTOWN, MASS.

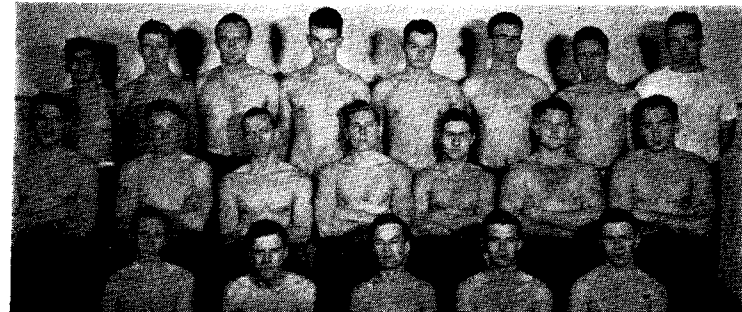

Front row—Williams Mathews Newlands Richards Koller. Row 2—Holzer Schwerzmann Harrington Cerny(C) Dunn Murray Lichtenberg. Back row—Tereazio Rodemich Anderson Ross Sandford Hartshorn Durando Coach Daniels.

WESLEYAN UNIVERSITY, MIDDLETOWN, CONN.

## Intercollegiate Wrestling in Ohio

By Claude B. Sharer, Coach Case School of Applied Science, Cleveland.

Eliminating Ohio State, there are four colleges in Ohio which support varsity wrestling teams. Case, Kent and Ohio University have had teams for years; Findlay College sponsored its first team last season and in a year or two will be holding its own in this district.



Front row—D. Strohl N. Carter Graven(C) R. Doan. Row 2—L. Littlepage D. Miller R. Beuck L. Sivon M. Bruno. Back row—Coach Begala R. Butler J. Alogdelis L. Pomeroy Watts(M).  
KENT STATE UNIVERSITY, KENT, OHIO.

The fifth annual interstate invitational Wrestling Championships were held at Case School of Applied Science, Cleveland. Entries from West Virginia University, Michigan State, Ohio University, Kent State, Rochester Mechanics Institute, Waynesburg, Denison University, Mount Union, Findlay and Case contributed to the most interesting and successful of these annual tournaments.

Kent State University, Michigan State and West Virginia carried off major honors, with the climax being reached in the final bout of the 135-lb. class, when

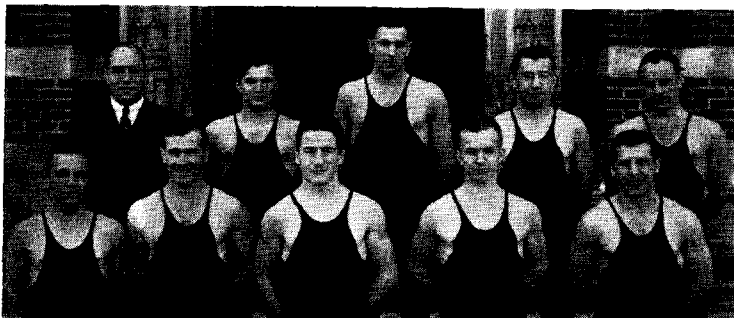

Front row—Gordon Purdy(C) Clifford Freiberger Ted Crowe Dale Ball Bill Mason. Back row—Coach Fendley Collins Dave Pletz Dale Stephenson Steve Slezak George Bird

MICHIGAN STATE COLLEGE, EAST LANSING, MICH.



Front row—R. Denton H. Jamieson S. Gurs A. DiVincenzo. Back row—Coach Claude B. Sharer C. Carlson R. Neville C. Zentgraf R. Webb J. Kaminskas Hanville(M).

CASE SCHOOL OF APPLIED SCIENCE, CLEVELAND, OHIO.

Buell Graven of Kent State, an Interstate champion, and E. Lancaster of West Virginia wrestled to a tie and were declared co-holders of the 1938 title.

Out of forty-seven bouts wrestled seventeen resulted in falls and only six went into overtime. Results were as follows:

118 lbs.—Satterfield (West Virginia), won; Strohl (Kent State), second; McGrane (Waynesburg), third. 126 lbs.—Doan (Kent State), won; Ball (Michigan State), second; Jimenez (Case), third. 135 lbs.—Lancaster (West Virginia) and Graven (Kent State), co-holders; Costellano (Rochester Mechanics Institute), third. 145 lbs.—Freiberger (Michigan State), won; Rand (Waynesburg), second; Sivon (Kent State), third. 155 lbs.—Pletz (Michigan State), won; Pomeroy (Kent State), second; Hammer (West Virginia), third. 165 lbs.—Carter (Kent State), won; Carlson (Case), second; Richards (Waynesburg), third. 175 lbs.—Nason (Case), won; Greenisen (Mount Union), second; Miller (Kent State), third. Heavyweight—Falcone (Kent State), won; Sullivan (Waynesburg), second; Zentgraf (Case), third.

The sixth annual Interstate championships are scheduled to be held at Washington and Jefferson College, Washington, Pa.



Front row—David West Eddie Feightner Harry Daghir Morgan Humphrey John Byal. Back row—Coach Nelson Jones Clarence Hine Sheldon Hall Ed Jalli Carver Oxley Cyril Reardon.

FINDLAY COLLEGE, FINDLAY, OHIO.

Ingall, Photo





Front row—Coach James Miller Dick Rand Dominick Mancini Jack Hutchins Jim McGrane.  
 Row 2—Brad Jones(M) John Sullivan(C) Earl Richards John Brewster Bill Radick. Back  
 row—Thomas Brown(AM) Pete Shills Willis Brown Wilbur Marissa.  
 WAYNESBURG (PA.) COLLEGE.

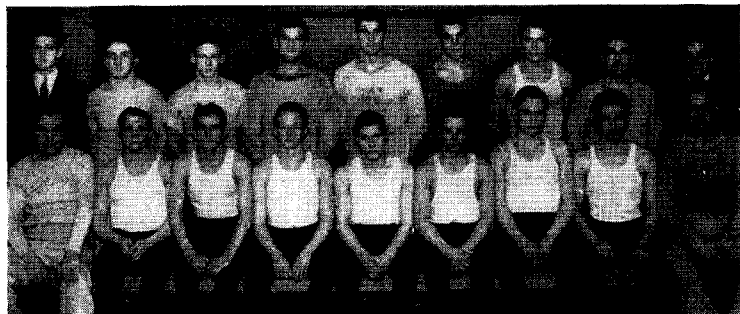

Front row—Coach Maysler Hamsher Burgess Lee Rupp Kapak Raub Conrad AsstCoach Holla-  
 baugh. Back row—Miller(AM) Low Bell Straak Saylor Schibanpf Cunningham Nagle  
 Stepinski(M). FRANKLIN AND MARSHALL COLLEGE, LANCASTER, PA.



Coach Peter Stevens Chas.Halm(M) John Knoll Gordon Astheimer Chas.Steinmetz George  
 Melkos Wm.Grove Willard Snyder TeruHayashi(C).  
 URSINUS COLLEGE, COLLEGEVILLE, PA.



Front row—August Bolinski Homer Lund Loel Ferguson Max Travis Don Blue Leo Kagan Max  
 Ferguson Don Bogott. Back row—Eddie Stewart Douglas Dunsmoor Dean Breitbach Walter  
 Hummel Howard Dunlap Merwya Bahling Ivan Moore Coach David McCuskey Davis Natvig.  
 IOWA STATE TEACHERS COLLEGE, CEDAR FALLS, IOWA.



Front row—Ayers Knudsen Collins Watson Crumbaugh Knight Miller. Back row—Harris  
 Klousia Bell Cole Taylor Mickey Hokonson West.  
 CORNELL COLLEGE, MOUNT VERNON, IOWA.



Front row—George Benz George Brinsmaid John Gillette Hayward Plumadore Thomas Stafford.  
 Back row—Stanley Koloski Coach Kenneth E.L.'Hon.medieu John Hamilton.  
 ST. LAWRENCE UNIVERSITY, CANTON, N.Y.

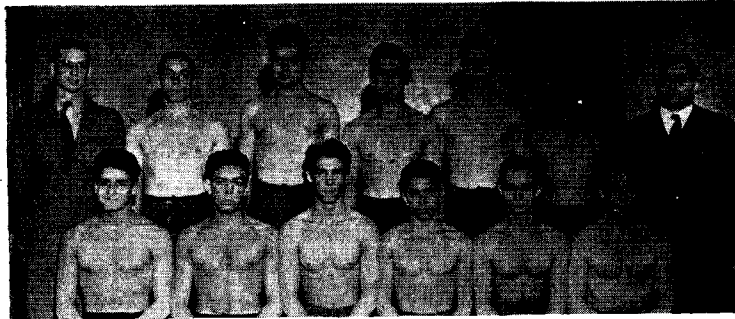

Front row—George Gasperian William Guttentag John Cook Richard Mansfield William Howarth William Chichester. Back row—Carl Clark (M) Otto Kunkel Ray Phillips Thomas Woerschling (C) LeRoy DeCamp Benjamin Hirsch Coach Fred Shepard.

RUTGERS UNIVERSITY, NEW BRUNSWICK, N.J.



Gamble Wilson Fort Benfield Craver Bailey Lowrance McIntyre. Dunbar & Daniel, Photo  
DAVIDSON (S.C.) COLLEGE.



Smith Dougherty Norris Wood Barnhill Crooks Gaskill Parks.  
APPALACHIAN STATE TEACHERS COLLEGE, BOONE, N.C.

## SCORES OF DUAL MEETS

### AMHERST (MASS.) COLLEGE.

0—Yale 36	24—Wesleyan 6	18—Williams 14
25—Springfield 11	26—Mass Inst Tech 8	20½—Tufts 11½

### ALFRED (N.Y.) UNIVERSITY.

13—Colgate 19	15—Buffalo 19	5—St Lawrence 31
21—Toronto 9	26—Rochester MI 8	15—Buffalo 17

### APPALACHIAN STATE TEACHERS COLLEGE, BOONE, N.C.

34—Winston-Salem 0	29—Tennessee 3	10—Maryville 0
26—Nwpt NewsApp Sch 5	30½—High Pt YMCA 1½	25½—High Pt YMCA 4½
25—Maryville 0		

North Carolina champions, and winner of the Carolinas A.A.U. championships, held at High Point. Scored 180 points to 14 for opponents. In the Maryville meets only falls counted.

### BROWN UNIVERSITY, PROVIDENCE, R.I.

27—Wesleyan 5	29—Springfield 5	14½—Michigan State 15½
13—Harvard 15	23—Mass Inst Tech 9	22½—Tufts 9½
3—Yale 29	24—Rutgers 6	

### CASE SCHOOL OF APPLIED SCIENCE, CLEVELAND, OHIO.

13—Ohio Univ 16	19—Washngtn-Jeffersn 11	21½—Buffalo 6½
19—Pittsburgh 9	32—Findlay 0	11—Kent State 17
10½—West Virginia 15½	6—Michigan State 20	

### CITY COLLEGE OF NEW YORK.

8—Franklin-Marshall 22	19—E Stroudsburg Thrs 13	15—Brooklyn College 11
19—Columbia 9	27—Bklyn Polytechnic 3	22—Temple 6

### CORNELL COLLEGE, MOUNT VERNON, IOWA.

29—Grinnell 5	4½—Frank-Marsh 23½	23—Chicago 3
9—Illinois 19	6—Indiana 22	10½—Minnesota 19½
14½—Cedar Falls Thrs 19½	24—Grinnell 8	21½—Nebraska 4½
21—Ohio University 8		

### FRANKLIN AND MARSHALL COLLEGE, LANCASTER, PA.

22—City Coll New York 8	36—Syracuse 0	26½—Michigan State 1½
34—Pittsburgh 0	32—Lafayette 0	33—Temple 3
23½—Cornell (Iowa) 4½	17½—Kansas State 10½	

### HARVARD UNIVERSITY, CAMBRIDGE, MASS.

30—Mass Inst Tech 0	20—Springfield 6	11—Penn State 17
15—Brown 13	9—Pennsylvania 19	8—Princeton 24
17½—Tufts 10½	8—US Naval Acad 20	11—Yale 15



Front row—Tomarelli Ardolino. Row 2—Dimit Cambal Coach Mazeski Roofner F.Kristufek. Back row—J.Kristufek (M) Flom Budzeika Cust McLeod Kingan King Slade (M) Sepic McNeill Taylor Lindstrom DeBlasio Doyle (M).

UNIVERSITY OF PITTSBURGH, PITTSBURGH, PA.



## UNIVERSITY OF ILLINOIS, URBANA, ILL.

30—Illinois Normal 0	19—Cornell College 9	14—Ohio State 12
26—Illinois Normal 8	3—Oklahoma A&M 27	6—Indiana 20
7½—Iowa State 18½	18½—Kansas State 7½	26—Iowa 6

## UNIVERSITY OF IOWA, IOWA CITY.

22—Northwestern 8	11—Cedar Falls Thrs 19	1½—Kansas State 32½
11—Wisconsin 17	11—Minnesota 19	6—Illinois 24
11—Iowa State 19	14—Nebraska 14	

## UNIVERSITY OF MICHIGAN, ANN ARBOR, MICH.

13—Indiana 19	26—Northwestern 6	19½—Ohio State 10½
32—Michigan State 0	36—Temple 0	29—Ohio Univ 0
22—Penn State 6	27—Lehigh 3	

## UNIVERSITY OF MINNESOTA, MINNEAPOLIS, MINN.

9—Iowa State 19	12—Kansas State 12	33—North Dakota 5
12½—Cedar Falls Thrs 15½	18½—Wisconsin 9½	19½—Cornell College 10½
36—Nebraska 0	19—Iowa 11	

## UNIVERSITY OF PITTSBURGH, PITTSBURGH, PA.

6—Franklin-Marshall 32	0—Kent State 28	1½—West Virginia 34½
9—Case 19	8—Waynesburg 24	
11—Temple 23		

## WASHINGTON AND JEFFERSON COLLEGE, WASHINGTON, PA.

11—Case 19	31—Findlay 5	14—West Virginia 18
6—Waynesburg 22	6—Kent State 28	3—Waynesburg 25

## WESLEYAN UNIVERSITY, MIDDLETOWN, CONN.

5—Brown 27	13½—Williams 14½	15½—Springfield 14½
6—Amherst 24		

## WEST VIRGINIA UNIVERSITY, MORGANTOWN.

17—Waynesburg 13	7½—Waynesburg 20½	18—Washington-Jeffson 14
4½—Ohio State U 21½	7½—Kansas State 24½	34½—Pittsburgh 1½
15½—Case 10½	22—Temple 10	

## WILLIAMS COLLEGE, WILLIAMSTOWN, MASS.

14—Amherst 18	14½—Springfield 9½	14½—Wesleyan 13½
28—Colgate 10	17½—Mass Inst Tech 14½	

## YALE UNIVERSITY, NEW HAVEN, CONN.

36—Amherst 0	30—Pennsylvania 0	18—Columbia 8
29—Brown 3	13½—Lehigh 12½	15—Harvard 11
25½—Cornell 4½	8—Princeton 22	

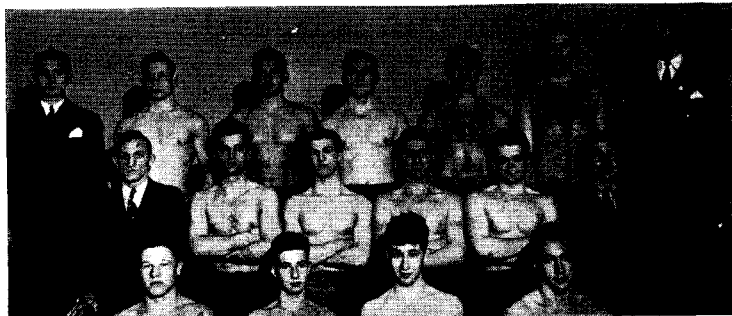

Front row—Allan Scherer Henry Simpson William Squire Abraham Marcus. Row 2—Coach Joseph Sapora Leo Wiznitzer (Co-C) Ralph Hirschtritt (Co-C) Harold Sklar Philip Kornfeld AsstCoach Joseph Warren. Back row—Harold Friedman (AM) Noah Krulewitz Henry Wittenberg Stanley Craze Sidney Malkin Charles Wilford Charles Smyth (M) Marcelle, Photo

CITY COLLEGE OF NEW YORK.

## IOWA STATE COLLEGE, AMES, IOWA.

18½—Wisconsin 4½	19—Minnesota 9	26—Nebraska 6
23½—Northwestern 4½	21—Cedar Falls Thrs 13	24½—Chicago 9½
18½—Illinois 7½	19—Iowa 11	

## IOWA STATE TEACHERS COLLEGE, CEDAR FALLS, IOWA.

35—Grinnell 5	13—Iowa State 21	23½—Nebraska 6½
19½—Cornell 14½	19—Iowa 11	16—Wisconsin 14
15½—Minnesota 12½		

## KENT STATE UNIVERSITY, KENT, OHIO.

15—Kent State Frosh 11	36—Findlay 0	24—Michigan State 6
32—Youngstown YMCA 0	17—Wisconsin 11	23—Washington-Jefferson 6
26—Ohio Univ 8	9½—Ohio State 18½	28—Pittsburgh 0
24—Waynesburg 6	15—Ohio Univ 11	17—Case 11

## MASSACHUSETTS INSTITUTE OF TECHNOLOGY, CAMBRIDGE, MASS.

0—Harvard 30	8—Amherst 26	0—Michigan State 38
10—Brooklyn 22	9—Brown 23	10—Springfield 24
9½—Tufts 24½	14½—Williams 17½	

## MICHIGAN STATE COLLEGE, EAST LANSING, MICH.

25—Wheaton 0	23—Northwestern 5	1½—Frankn-Marshall 26½
0—Michigan 32	20—Case 6	15½—Brown 14½
6—Ohio State 26	6—Kent State 24	38—Mass Inst Tech 0

## RUTGERS UNIVERSITY, NEW BRUNSWICK, N.J.

0—Princeton 32	16—Montclair Thrs 14	6—Brown 24
3—Columbia 27	6—Lafayette 22	38—Penn Mil Coll 0

## ST. LAWRENCE UNIVERSITY, CANTON, N.Y.

27—E Stroudsburg Thrs 3	19—Syracuse 11	31—Alfred 5
38—Queens University 0	27—Colgate 5	19—E Stroudsburg Thrs 9
28—Toronto University 8		

## SPRINGFIELD (MASS.) COLLEGE.

11—Amherst 25	6—Harvard 31	14½—Wesleyan 15½
9½—Williams 24½	5—Brown 29	24—Mass Inst Tech 10
8—E Stroudsburg Thrs 21	13—Tufts 19	

## TUFTS COLLEGE, MEDFORD, MASS.

24½—Mass Inst Tech 8½	0—Franklin-Marshall 36	11½—Amherst 20½
10½—Harvard 17½	19—Springfield 13	9½—Brown 22½
10½—E Stroudsbgr Thr 15½		

## UNIVERSITY OF IDAHO, MOSCOW, IDAHO.

19—Washington 11	23—Montana State 6	19—Wash Sta 24—Wash 24
28—Washington State 8	14—Washington State 14	



Front row—Gilbert Dayton Robert Jones Robert Snow Paul Powers. Row 2—Kenneth Denning John Augustine Francis Paquin Jack English Wm.Howes Bernard Swift Chris Rallis. Back row—Coach E.W.Pennock Wm.Knowles Henry Shambaugh Gus Lindgren AsstCoach Bliss Sargeant Hiram Doty (M).

SPRINGFIELD COLLEGE, SPRINGFIELD, MASS.

## • INTERSCHOLASTIC WRESTLING •

### Nationwide Notes on High School Wrestling

By B. E. Wiggins, National High School Federation Representative on N.C.A.A. Rules Committee.

**CALIFORNIA**—Again climate is a factor in sports excellence in the "Long State." Mr. Crosby (San Diego) truly attributes interest and success to the root factor—constant intramural activity. San Jose won the Northern California championship held at Oakland and Whittier the title for Southern California.

**NEW JERSEY**—The fine groups elsewhere reproduced evidence continual activity in New Jersey. The Lehigh interscholastics produced excellent performances. The "Old Master" (Sheridan) retains his vigor and leadership in the sport.

**OKLAHOMA**—Still the leader, all things considered. A pioneer (in this case, positively, Mr. Gallagher) usually plans well and carries on by example, plus the interest aroused in his followers. The success of the state's high schools—meaning sound technique and statewide activity—continues on its upward and onward way.

**MARYLAND**—A fine record for Gilman Country Day School! Let us hope for wider activity in the Free State this year.

**WISCONSIN**—With the sponsorship of the state association this year, and continued efforts by the university, wrestling in the high schools should advance rapidly. Coach Martin at Madison is largely responsible for much of the progress made in the state.

**OREGON-WASHINGTON**—Compliments are in order to this Northwest area of the nation. It is apparent that leadership, strong interest by all concerned, and solved transportation problems conduced, one and all, toward the great progress the mat sport has made in that section, where high school wrestling has established itself on a fine basis. Jones, Mulford and Bevan of the Hill Academy team of Portland deserve much credit for their interstate championships. Stay with it!

In 1933 six states conducted state sponsored tournaments. At this writing, seventeen states are on the record.

Although there is considerable activity in the form of duals and intramurals, no definite reports have been received from Michigan, Indiana, Georgia, Massachusetts, the Dakotas, Maine, Connecticut, Louisiana, North Carolina, Wyoming, and a few other areas. Lack of trained leadership appears to be the principal handicap, so far as the immediate development of the sport is concerned.

The various suggested changes in the rules received each year are thoroughly discussed by the entire Rules Committee. It is obvious that only such changes or additions to the present code conducive to the safety of young wrestlers, and

at the same time the retention of the essential movements and maneuvers of this vigorous sport, shall be the final consideration. The respective merits of "point awards" for advantage, escape, etc., are still in the "trial and error" stage.

**OHIO**—After several years unceasing efforts on the part of those who believed that wrestling should be an integral part of the sports program, the first state tournament was held last season in Cleveland under the auspices of the City Physical Welfare Department and John Hay High School, the result of which was in doubt until the last two bouts, when Hay emerged as winner. Everyone connected with the meet should feel repaid for his interest and the work it entailed. The outstanding characteristics of the mat work displayed were the leg work and balance in evidence by the finalists. This year the state probably will be divided into districts (as for other sports) so that many young competitors from the more remote areas may enter.

**MINNESOTA**—A wholesome wrestling growth is in evidence. Physical sturdiness and life in the open should be favorable factors for increasing activity. The University of Minnesota has accomplished much in the past and will continue its lusty efforts in 1939.

**NEW YORK**—Reports each year from various areas indicate a "growing trend" in the form of district duals and tournaments. A few years ago it was difficult to ascertain the extent of this sport. Today, the interest and activity reported may be termed excellent. Keep on coming, New York!

**ILLINOIS**—Leadership and hard work are manifest in the continued success of statewide participation for the second successive year. The report of Mr. Kenney reveals growth of the sport and many other highlights. Good work, Proviso! In Chicago, Mr. Fritzlaff's report speaks for itself. A Tilden-Proviso dual should pack them in.

**PENNSYLVANIA**—Ten district meets and the first state championship tournament are recorded for 1938 in the Keystone State. From the printed word alone, it is evident that Cannonsburg is wrestling conscious—and very successful!

**COLORADO**—Out in this high country the sport continues to grow. No sign on the ceiling of the gym reading "Don't look up" is necessary.

**IOWA**—The Hawkeye State maintains its high ranking, as in past years. Close and widespread meets over this area attest progress. One need only read over the reports further on to be convinced.

**KANSAS**—Kansas State College has been and is a heavy contributor to high school wrestling. This is also true of other states. Fine work, St. Francis!

**NEBRASKA**—The Cornhuskers hold their high pace and place. There is "a something" in the big delta conducive to high grade wrestling. Leadership may be the answer.

In the event of failure to receive a request for photos and the season's record on or before May 10, 1939, please mail such data to the writer at 270 East State St., Columbus, Ohio.

The substance of all contributions to the Guide is sent to the publisher. If, for lack of space, some of this is omitted, the writer is none-the-less appreciative.



Front row—Brdar Leybeck Weisenberg Incorvaia(C) Keane Scrima. Back row—Albanese(M) Jaros Chojnicki Kolesnicki Heller Cavano Ranallo Coach Kester.

JOHN HAY HIGH SCHOOL, CLEVELAND—OHIO STATE CHAMPIONS.

### FIRST ANNUAL OHIO INTERSCHOLASTIC CHAMPIONSHIP MEET

By Harold D. Kester, Coach of Wrestling, John Hay High School, Cleveland.

Interscholastic wrestling in the state of Ohio saw a marked increase in number of schools participating during the past season. A great many inter-sectional dual meets were held, with the attendance more than satisfactory.

Last season marked the beginning of interscholastic state championship competition in Ohio when the first state championships were held at John Hay High School, Cleveland, March 18 and 19, 1938. The entry list included twenty-one high schools from every part of the state, with 126 individual entries. Competition was close and officials and coaches expressed themselves as more than pleased at the quality of wrestling exhibited.

Due to the fact that the teams came from widely scattered sections of Ohio, it was impossible to do an efficient job of seeding, with the result that in a few instances two very good boys met in the first round. However, until we

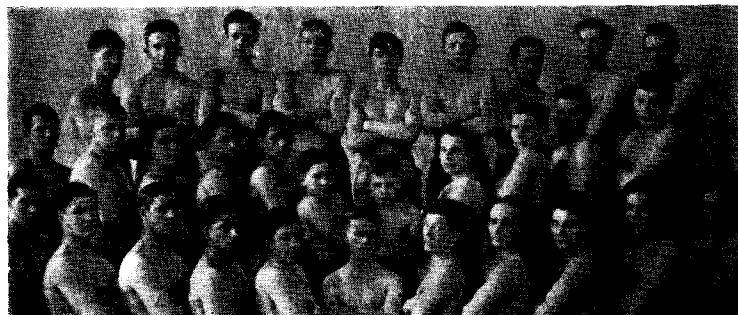

Front row—F.Schaad B.Reed J.Reedy P.Moore N.Boice W.Alban E.Staker B.froom M.Newhouse J.Johnston J.Lewis. Row 2—D.McCoy M.Lindquist C.Verhine H.Avern T.Rhodes J.Zikas B.Quinn C.Latimer H.Thomae C.Radow R.Lowther. Back row—S.Mascari J.Marx D.Wilgur C.Thomae P.Lee C.Ramey F.Critchfield L.Holsky J.Gunning.

EAST HIGH SCHOOL, COLUMBUS, OHIO.

have more dual meets between teams from different districts, it will be almost impossible to make an even distribution of talent.

The officiating seemed to be far above the average, and in most instances decisions were accepted without a question. While rivalry was very strong between a number of the schools entered in the tournament, there was not a single instance of poor sportsmanship.

No one district predominated, although the Cleveland district had a great many more boys entered than any other section. When the semi-final rounds were reached it was found that the boys were scattered and all districts well represented. It was not until the second last match of the final round that the team championship was decided with Hay of Cleveland nosing out Rhodes of Cleveland by two points, to win the first Ohio state tournament. Akron East was third.

The tournament saw many individual stars, Joe Incorvaia of Hay probably turning in the best performance by pinning all of his opponents. However, there were several boys who by their outstanding performance challenged Incorvaia's supremacy.

Mr. Floyd Rowe, Director of Physical Welfare of the Cleveland Board of Education, was in charge of the tournament. The referees were Del Busha of Ohio University, James Bennett of Ohio State, and Joe Tabor of Kent State. Mr. B. E. Wiggins of Columbus, Ohio, representative of the National High School Federation, was Honorary Referee.

The schools entered in the tournament comprised Alliance, three schools from Columbus—Central, East and West; three from Akron—East, Garfield and North; Cuyahoga Falls, Lakewood, Parma, Shadyside and Wadsworth. Cleveland was represented by eight schools—Garfield Heights, James Ford Rhodes, John Hay, John Marshall, Lincoln, South, West and West Tech.

Individual winners: 95 lbs., Brdar (JH), won; Kesselring (AE), second. 105 lbs., Ingram (JFR), won; Jarzynski (GH), second. 115 lbs., Engler (W), won; Weakland (AE), second. 125 lbs., Hubbard (AE), won; Stamatis (WT), second; 135 lbs., Incorvaia (JH), won; Sullivan (GH), second. 145 lbs., Wolf (W), won; DiNapoli (AG), second. 155 lbs., Kakosky (JFR), won; Couvdos (AE), second. 165 lbs., Bujak (GH), won; Hibbard (CF), second. 185 lbs., Schleicher (JFR), won; Nall (AG), second. Unlimited, Mueller (CW), won; Greenfield (All), second.

### INTERSCHOLASTIC WRESTLING IN THE AKRON (OHIO) AREA

By F. F. Cngley.

Akron Garfield won the city championship by defeating Akron East before a crowd of 850 spectators, the largest number ever to witness a scholastic wrestling match in this city. East had been undefeated for two years in the district

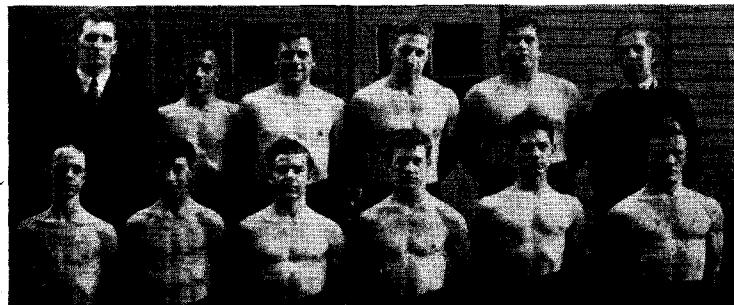

Front row—Kesselring Bancheck Weakland Hubbard(C) Communale Pinder. Back row—Coach F.F.Cngley Couvdos Yen Endres Smith Martin(M).

EAST HIGH SCHOOL, AKRON, OHIO.

prior to the Garfield match. However, East went on to win the district championship for the third successive year and placed third in the state meet, being pushed out of second place by the margin of one point by Cleveland John Rhoades. All in all, the season was very successful, as attendance was good and enthusiasm ran high.

Those of us who are in the Akron area feel that we have made some worthwhile changes for 1939. First of all, we have formed a more closely united league, each team meeting every other team on a home-and-home basis, with the championship being decided on a percentage basis. In case of a tie the two leading teams are to meet in a third match on a neutral mat. Furthermore, at the close of the dual meet season an individual championship tournament will be held with two points in view: first, to give the boys of the district some actual tournament experience; second, to select first and second place winners for the state meet, so as to cut down the number of entries and therefore improve the wrestling in the meet.

Akron East's record for 1939 shows eight wins and two losses, with a total of 236½ points to opponents' 126½—with a victory over Cleveland John Hay, state champions for 1939. The record:

21—John Hay 19	10½—West Tech 21½	36½—Akron South 6½
34—Wadsworth 8	34½—Alliance 10½	14—Akron Garfield 17
18½—Cuyahoga Falls 10½	26½—Akron North 10½	19—Cuyahoga Falls 12
22—Wadsworth 11		

### INTERSCHOLASTIC WRESTLING IN THE CLEVELAND (OHIO) DISTRICT

Undefeated champions of the district for the year was the proud honor of Garfield Heights High School, which turned in a total of 274 points to 47 for opponents in ten dual meets, and although relatively a small school (only about 1,200 pupils in junior and senior high) was able to vanquish such teams as John Hay, Cleveland city champions of the previous year, and West Tech, hitherto undefeated city champions last season. The record:

Garfield 17, Alumni 9; 34, Lincoln 7; 41, Parma 0; 19, South 7; 30, Shore 2; 27, John Hay 5; 28, Lakewood 1; 23, University 8; 38, Euclid 0; 17, West Tech 9. Not an opponent was able to score a total of ten points.

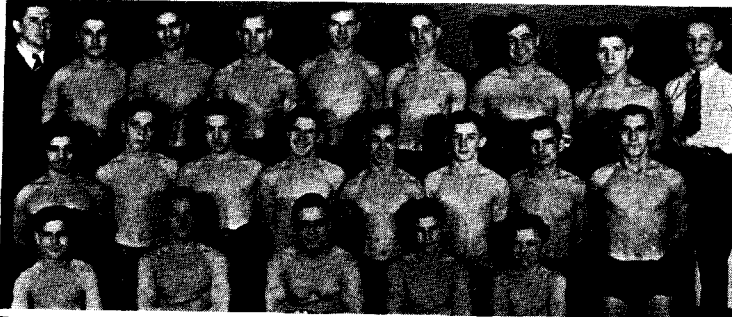

Front row—Tomaselli J. Caputo A. Caputo Jarzynski Skyrn. Row 2—Cardemone Jacobsen Dickson Ritson Brooks Butala Kozenny Grof. Back row—Coach S.F. Bobenmyer Cherri Stock Sullivan Bujak Ford Glass Kaputa Kratochvil(M).

GARFIELD HEIGHTS HIGH SCHOOL, CLEVELAND, OHIO.

### WRESTLING IN THE CHICAGO PUBLIC HIGH SCHOOLS

By A. E. Fritzlafl, Director Physical Education.

Wrestling among the member schools of the Chicago Public High Schools Athletic Association is divided into a team championship, decided by a series of dual meets, and individual championships, decided by an elimination tournament. The team championship was won by Tilden High School with nine victories and no defeats. This makes Tilden's ninth championship in the fourteen years of wrestling competition.

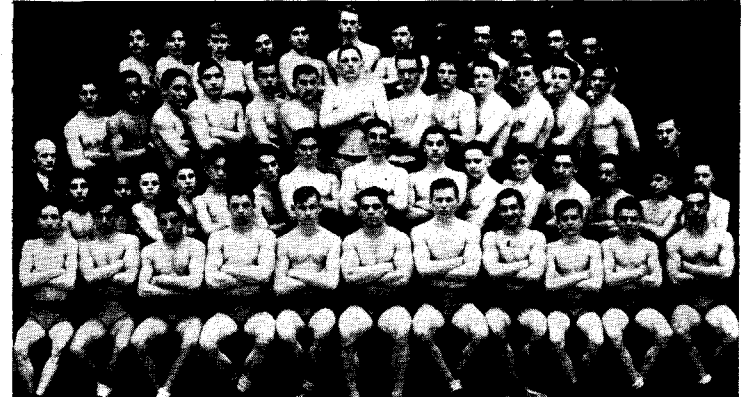

Front row—Lamberis Lasser Barbaro Sczpaniak Zaidlicz Fisher(C) Butkus Skowronski Frey Kolkebeck LaPlace. Row 2—Coach R.D. Hicks Melos Millet Nelson Pryor Wong Gregory Halverson Nestler Belt Siasiewicz Kelly George Harry Stanley Sakagaw Rolak. Row 3—Kulzewski Neil Heda Ferreri Balaska Kuhn Friedlander Curtis Hurvitz Yez Jacob Davies Umperovitch Barkauskas(M). Back row—Lesewicz Holloway Wolf Carstopulos Walek Ludka Kamien Boyd Ferrotta Roeshe Warren Stanley Bob Stanley.

TILDEN HIGH SCHOOL, CHICAGO ILL.

Results of Tilden dual meets were as follows:

Tilden 38, Morgan 8; 42, Parker 0; 29 Calumet 9; 39, Crane 5; 22½, Fenger 15½; 29½, Englewood 10½; 26, Amundsen 14; 29, Lindblom 13; 19½, Bowen 16½.

Individual championships were held at the field house of the University of Chicago, April 8 and 9, 1938. Winners:

95 lbs., Good (Amundsen), won; Nolan (Lindblom), second. 105 lbs., Christmas (Englewood), won; Hyland (Calumet), second. 115 lbs., Zulka (Bowen), won; Cregor (Amundsen), second. 125 lbs., Skowronski (Tilden), won; Pollock (Crane), second. 135 lbs., Jones (Lindblom), won; Antonisen (Bowen), second. 145 lbs., Tambros (Calumet), won; Laglora (Crane), second. 155 lbs., Erwin (Englewood), won; Swanske (Calumet), second. 165 lbs., Kozlowski (Crane), won; Howes (Fenger), second. 175 lbs., Fisher (Tilden), won; Yablanski (Crane), second. Heavyweight, Rymkus (Tilden), won; Reagan (Lindblom), second.

### HIGH SCHOOL WRESTLING IN ILLINOIS

By H. D. Kenney, University of Illinois.

The first statewide wrestling tournament sponsored by the state high school athletic association was held in the spring of 1937 at University of Illinois, Urbana. In this first state tournament twenty schools were represented with 102 contestants. Last season thirty-two schools entered men and the number of entries was 193. Due to weather conditions on the weekend of the tournament,



Front row—Paul Anderman Edwin Bevin Robert Mustain Charles Ramus. Row 2—Fred Bishop Ted Seabrook Jim Johnson Blair Remick Leonard Humphreville Coach C.W.Bills. Row 3—Robert Hillan(M) Marvin Millush(M) James Mustain Arthur Fry John Castleman Coach L.F. Slimmer. Back row—Thomas Bishop Frank Preston Wilbert Rittmueller Tom Stackpool Al Scharf John DeLaPaz Joe Marco.

PROVISO TOWNSHIP HIGH SCHOOL, MAYWOOD, ILL.

however, only 155 contestants actually weighed in for competition. In many respects it was fortunate that all those entered did not arrive, since the tournament was really too large for a two-day affair.

Plans are being made to hold four sectional tournaments this year, with only first and second place winners in each weight division qualifying for the finals to be held one week later. In this way each tournament will be small enough to be easily handled and it also will eliminate the possibility of overworking the contestants.

The interest in interscholastic wrestling has been growing rapidly since the state association has sponsored a state championship meet. At present there are approximately forty schools holding dual meets and from all indications there may be as high as fifty teams represented in this season's tournament. The degree of skill shown by the various teams is rapidly increasing. Results of the 1938 state championship tournament (first seven teams) were as follows:

Team points—Proviso 26, Champaign 24, Tilden 18, Lewistown 16, Bowen 14, Calumet 13, Granite City 12. Individual winners: 95 lbs., Moyer (Ch), won; Fricker (GCity), second; Swanson (B), third. 105 lbs., Sanford (Ch), won; Bishop (P), second; Stanley (T), third. 115 lbs., Bearce (L), won; Lasser (T), second; McDaniels (Ch), third. 125 lbs., Anthonisen (B), won; Skoronski (T), second; Stasi (P), third. 135 lbs., Bayer (GCity), won; Wilson (L), second; Aloia (B), third. 145 lbs., Lambros (Cal), won; Lagiola (Crane), second; Ratcliff (L), third. 155 lbs., Seabrook (P), won; Wahle (A), second; Swanke (Cal), third. 165 lbs., Marsh (Cal), won; Mustain (P), second; Butkins (T), third. 185 lbs., Remick (P), won; Wilson (Ch), second; Fisher (T), third.

## INTERSCHOLASTIC WRESTLING IN WISCONSIN

By G. A. Martin, University of Wisconsin.

Wrestling in Wisconsin high schools made rapid progress during the past school year. We are really going ahead here.

The Wisconsin Interscholastic A.A. sponsored a series of clinics during September and October and November of 1937, holding the clinics in various cities in the state. Demonstrations and exhibitions were given and the high schools were made wrestling conscious. As a result many high schools have taken up wrestling, and about forty schools initiated the sport in either an interscholastic or intramural way. The schools which have wrestled before were much improved.

It is proposed to hold the first Wisconsin state high school tournament this winter. The high school association is behind the sport, and as soon as the schools demonstrate that they are ready to support a state tournament the association will sponsor the meet.



Front row—Dean McOllough Tom Whitty Ronald Armour Paul Bell Bill Kirstein. Back row—Coach Virgil Dueda Don Sharp Merle Armour Gerald Blackman Clayton Brown Alfred Pehl.

CLARION (IOWA) HIGH SCHOOL—STATE CHAMPIONS.

## INTERSCHOLASTIC WRESTLING IN IOWA

By Fred Cooper, Fort Dodge High School.

Interest in high school wrestling continued to develop during the season of 1937-38 in Iowa. Several schools introduced the sport in their extra-curricular program.

**State Championships**—In the state championship meet, held at Fort Dodge, Clarion carried off premier honors in team point scoring with 21 points; Valley and Fort Dodge tied with 17 points each for runner-up position, while Mason City accumulated 12. Ten other schools scored points. Total point scoring was as follows: Clarion 21, Valley (Des Moines) 17, Fort Dodge 17, Mason City 12, West Waterloo 9, Cresco 7, Osage 5, Eagle Grove 4, Burt 3, Cherokee 3, New Hampton 3, East Waterloo 3, I.S.B. 2, Dubuque 1. Individual results: 85 lbs., McOllough (Cl), won; Christen (WW), second; Fuller (V), third. 95 lbs., Leeman (O), won; Tuttle (Cr), second; Stewart (Ch), third. 105 lbs., Paul Macek (FD), won; McGee (NH), second; Bateman (Cr), third. 115 lbs., Bell (Cl), won; Bales (FD), second; Stamatelos (V), third. 125 lbs., Thompson (MC), won; Kirstein (Cl), second; D.Roberts (V), third. 135 lbs., Muhl (FD), won; Lindholm (EW), second; Creel (Ch), third. 145 lbs., Penn (WW), won; Weiske (Burt), second; Blackman (Cl), third. 155 lbs., Rumelote (MC), won; Hudgins (EG), second; Brodene (ISB), third. 165 lbs., J.Roberts (V), won; Culbert (Cr), second; Johnson (FD), third. Heavyweight, Bennett (V), won; Sharp (Cl), second; Penaluna (WW), third.

**Northeast Iowa Tournament**—In the Northeast Iowa district tournament at Cresco on February 18 and 19, 1938, seventy-five boys competed. Competition was keen and five of the leading schools were closely grouped when the final points were added, Cresco again capturing the title after a stiff battle with Osage, New Hampton, East Waterloo and Dubuque. Osage, with only three years' experience, produced a strong dual meet team. New Hampton was also represented by its usual well balanced team. East Waterloo, West Waterloo, Dubuque, Davenport, Clinton, Lamont, Tripoli and Oelwein also wrestled complete schedules.

Team scores—Cresco 33, New Hampton 21, Osage 21, East Waterloo 17, Dubuque 14, Tripoli 8, I.S.B. 5. Lamont and Oelwein did not score.

## RESULTS (IOWA) DISTRICT WRESTLING TOURNAMENT.

**Cherokee**—In the district tournament held at Cherokee, February 18 and 19, 1938, Clarion was first, with 40 points, closely followed by Cherokee, with 38. In individual scoring winners of first and second places qualified for the state championship tournament. Team scores: Clarion 40, Cherokee 38, Abraham Lincoln 12, Gilmore City 11, Thomas Jefferson 10, Sidney 1, Cleghorn 1. Individual results: 85 lbs., McOllough (Cl), won; Rapson (Ch), second. 95 lbs., Stewart (Ch), won; Poncelow (TJ), second. 105 lbs., Landmesser (GC), won; Julius (Ch), second.

115 lbs. Bell (CI), won; Knight (AL), second. 125 lbs. Kirstein (CI), won; Kirby (GC), second. 135 lbs. Armour (CI), won; Creel (Ch), second. 145 lbs. McManus (Ch), won; Blackman (CI), second. 155 lbs. Haley (Ch), won; Gelpert (TJ), second. 165 lbs. Woodworth (Ch), won; Brown (CI), second. Heavyweight, Sharpe (CI), won; Steele (Ch), second.

**Fort Dodge**—Fort Dodge won in its district championship, held at Fort Dodge, February 18 and 19, 1938, and went on to the state tournament, where it tied Valley High of Des Moines for second. Team scores: Fort Dodge 42, Mason City 29, Eagle Grove 19, Burt 8, Algona 7, Perry 3, Iowa Falls 1, Paton 0. Individual results (first and second to qualify for state tournament): 85 lbs. M. Macek (FD), won; Bernard (EG), second. 95 lbs., Thorson (FD), won; Decker (MC), second. 105 lbs., P. Macek (FD), won; Walter (MC), second. 115 lbs., Buffington (MC), won; Bales (FD), second. 125 lbs., Thompson (MC), won; Dean Cummings (FD), second. 135 lbs., Muhl (FD), won; Calicchia (MC), second. 145 lbs., Weiska (Burt), won; Dale Cummings (FD), second. 155 lbs., Tom Rumlote (MC) won; Iudgins (EG), second. 165 lbs., Johnson (FD), won; Vanwart (A), second. Heavyweight, Folkedahl (EG), won; Nelson (P), second.

**West Des Moines**—Team points: West Waterloo 49, Valley 36, North Des Moines 14, East Des Moines 10, Roosevelt 4, Grinnell 3, Davenport 2. Individual winners: 85 lbs., Christian (WW). 95 lbs., Miller (NDM). 105 lbs., D. Wilcox (WW). 115 lbs., J. Wilcox (WW). 125 lbs., D. Roberts (V). 135 lbs., Florer (V). 145 lbs., Penn (WW). 155 lbs., Hauser (WW). 165 lbs., J. Roberts (V). Heavyweight, Penaluna (WW).

## HIGH SCHOOL WRESTLING IN MINNESOTA

By D. C. Bartelma, University of Minnesota.

Wrestling is developing rapidly in Minnesota. Several schools introduced wrestling last season and many others are expecting to add it to their programs in the near future. At least ten schools conducted dual meet schedules and sixteen schools entered the second annual state high school tournament held at the University of Minnesota. This is almost a one hundred per cent increase over the competition of the preceding season. A meet for metropolitan schools was conducted in Minneapolis and Duluth Y.M.C.A. held a Head of the Lakes meet for high school wrestlers of the northern section of the state.

Marshall High School of Minneapolis won the team state championship, with Osakis High a close runner-up. Individual place winners were: 85 lbs., Brakke (Milroy); 95 lbs., Rooney (Robbinsdale); 105 lbs., VanGordon (Marshall); 115 lbs., Swartz (Osakis); 125 lbs., Zaychek (Marshall); 135 lbs., Cecere (Marshall); 145 lbs., DeLuc (Marshall); 155 lbs., Johnson (Osakis); 165 lbs., Hetfield (St. Paul Central); heavyweight, Levy (Minneapolis West).



1 Bobby Barbe 2 Sam Cecere 3 Frank Zaychek 4 Charles Scanlon 5 John O'Neal 6 Douglas Ebedstrom 7 James VanGordon 8 Laurel Booth 9 Con Emerson 10 Bill Anderson 11 Coach Evan Jones 12 Frank DeLuc 13 Don Johnson. Preston A. Reed, Photo

JOHN MARSHALL HIGH SCHOOL, MINNEAPOLIS, MINN.

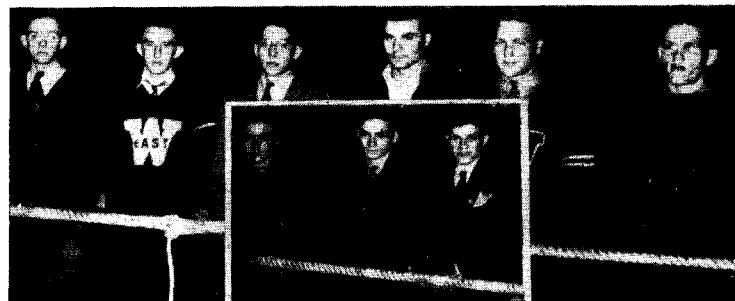

Wheeler (Douglass Hs) Mellon (Wichita East) Rossel (Hutchinson) Wellman (St. Francis) McClellan (Wichita East) Wagner (St. Francis) Boyer (Colby) Hastings (Wichita North) Hancock (St. Francis).

KANSAS INTERSCHOLASTIC STATE CHAMPIONS.

## INTERSCHOLASTIC WRESTLING IN KANSAS

By B. R. Patterson, Kansas State College, Manhattan.

The growth of high school wrestling in Kansas is steady and satisfactory, and is on the upgrade in quality of wrestling, coaching, competition, and number of schools participating.

At the annual state meet, held at Kansas State College, injuries were few, if any; in fact, I do not remember one that was serious. Only two defaults were due to injury. With twelve schools competing this was a good showing. None of the injuries was serious. At the end of the high school meet a dual meet was staged with Iowa University, and the high schools were the guests of the athletic department.

Team scores: St. Francis 32, Wichita East 22, Oberlin 18, Hutchinson 8, Douglass 8, Colby 8, Wichita North 7, Newton 7, Atwood 5, Hoxie 3, Goodland 2, Manhattan 0. Individual winners: 95 lbs., Wheeler (D), won; Winston (StF), second. 105 lbs., Mellon (WE), won; Jackson (H), second. 115 lbs., Rossel (H), won; Rueb (StF), second. 125 lbs., Wellman (StF), won; Danham (WE), second. 135 lbs., McClellan (WE), won; Emmerson (O), second. 145 lbs., Wagner (StF), won; Vavorch (O), second. 155 lbs., Boyer (C), won; Olson (O), second. 165 lbs., Hasting (WN), won; Ruda (A), second. 175 lbs., Hancock (StF), won; Siebel (WE), second. Heavyweight, Brandt (N), won; Helencamp (O), second.



Supt. Greene Coach R. Wheraty. John Hancock Raymond Lampe Steve Newman Howard Wagner William Wellman Robert Scoby Alfred Rueb Robert Keller Borman Winston.

ST. FRANCIS (KAN.) COMMUNITY HIGH SCHOOL.



Front row—F. Fluhr L. Circo P. Riplog R. Reynolds. Back row—R. Engdale J. Jones J. Partusch D. Probst F. Remington A. Hodges Ray Shaw F. Frum L. Klacsan W. Raglin Sherman. Photo

OMAHA TECH HIGH SCHOOL, OMAHA, NEB.

## INTERSCHOLASTIC WRESTLING IN NEBRASKA

By R. L. Carns.

The Nebraska state meet was a three-way battle in which Omaha Central, South and Tech figured, with the final result in doubt until the last consolation match had been decided. All the contesting schools managed to score at least one point, with four out of six schools sharing individual championships. All contestants appreciated working on the large 30-foot mat that the university provided.

Team scores: Omaha Tech 34, Omaha South 28, Omaha Central 27, Omaha North 11, Minden 8, Rokeby 1. Individual championships: 85 lbs., Reynolds (T); 95 lbs., Evans (C); 105 lbs., Riplog (T); 115 lbs., Young (C); 125 lbs., Circo (T); 135 lbs., Fluhr (T); 145 lbs., Thomas (N); 155 lbs., Alexander (S); 165 lbs., Newquist (S); heavyweight, Harder (S).

It was the second state championship for Harder and the third for Riplog.

High school wrestling in Omaha and Council Bluffs maintained a high grade of excellence last season. There were not quite so many dual meets as in past years, since the two Council Bluffs schools and Creighton Prep chose to compete in a single round robin, the other schools scheduling a double round robin. There were no serious injuries in connection with any of the high school wrestling meets in the vicinity. The individual championship meet was not held because of the shortened school year and consequent rush in activities. South High again won the championship with a perfect record of nine victories, although several of the dual meets were close contests. This gives South and Tech each one win toward the Baburek Trophy. Team standing: South 9, Abraham Lincoln 4, Thomas Jefferson 3, Tech 4, Central 4, North 1, Creighton Prep 0.

## INTERSCHOLASTIC WRESTLING IN OKLAHOMA

By L. K. Anderson, Oklahoma City, and H. B. Anderson, Ponca City.

Wrestling has been spreading continuously in Oklahoma since its inauguration by Coach E. C. Gallagher of Oklahoma A. & M. several years ago, where the annual scholastic meet was held each year until 1933. The latter tournament was so large that the Oklahoma High School Athletic Association took charge and divided the state into four districts. An elimination tournament was held in each to qualify eight wrestlers in each weight for the official state championship tournament. This plan was followed in 1934-35-36-37.

District tournaments were too large in 1937, so the state was re-divided into five districts, with three wrestlers qualifying from each district in each weight.

The new plan met with outstanding success and enthusiasm. Of seventy-eight schools that participated in wrestling sixty-eight sent teams to the district tournaments, while thirty-five schools succeeded in qualifying from one to nine wrestlers for the final state championship meet.

Team champions in the five districts were: Geary, Pauls Valley, Ponca City, Tulsa Central, and Elk City.

At the championship meet, held at Southwestern Teachers College, in Weatherford, March 11 and 12, 1938, the leading team scores were: Tulsa Central 20, Ponca City 17, Geary 12, Elk City 10, Weatherford 9, Blackwell 7, Guthrie 6, Sulphur 6. Henslee, Kitt and Shelton were repeating champions in their respective events.

Individual state champions: 95 lbs., McDonal (TCU), won; Richardson (Geary), second; Coleman (B), third. 105 lbs., Henslee (EC), won; Lundy (PC), second; Sullivan (Bristow), third. 115 lbs., Kitt (TCU), won; Palmer (Stillwater), second; Marks (PC), third. 125 lbs., Jacobson (CH), won; Whitehurst (Ardmore), second; Crothers (Geary), third. 135 lbs., Johnson (TCU), won; Sodowsky (B), second; Grant (Cushing), third. 145 lbs., Maxwell (TCU), won; Keas (EC), second; St. Johns (Tulsa Clinton), third. 155 lbs., Gibbs (Guthrie), won; Hambrick (W), second; Gregg (Sand Springs), third. 165 lbs., Shelton (PC), won; Harrold (TCIn), second; Bolding (Hobart), third. 185 lbs., Arms (S), won; McClanahan (W), second; Leonard (Geary), third.

## INTERSCHOLASTIC WRESTLING IN COLORADO

By John W. Hancock, Greeley State College.

Last season marked a decided improvement in wrestling in Colorado. Many schools have introduced the sport, and others are experimenting with it, but so far competition is confined to Northern Colorado and on the Western slope of the state. There has been a steady increase in the number of schools represented at the state meet, held annually at Greeley State College, and in the number of contestants.

In the third annual state high school tournament, held as usual at Greeley State College, Grand Junction High won with 30 points; North Denver was runner-up, with 22 points, closely followed by Manual High of Denver, with 22. Complete team point results were as follows:

Grand Junction 30, North Denver 22, Denver Manual 20, Fort Morgan 16, East Denver 14, South Denver 13, Greeley High 10, Denver West 6, Montrose 6, Fort Collins 5, Loveland, Greeley College High, Yuma, Olathe, Golden, Sterling and Gilcrest also competed. Individual champions: 95 lbs., Hayashi (GJ); 105 lbs., Helton (SD); 125 lbs., Gardner (ED); 135 lbs., Hancy (ND); 145 lbs., Snodgrass (G); 155 lbs., Schaurman (FM); 165 lbs., Carroll (ND); 185 lbs., Mann (FM).

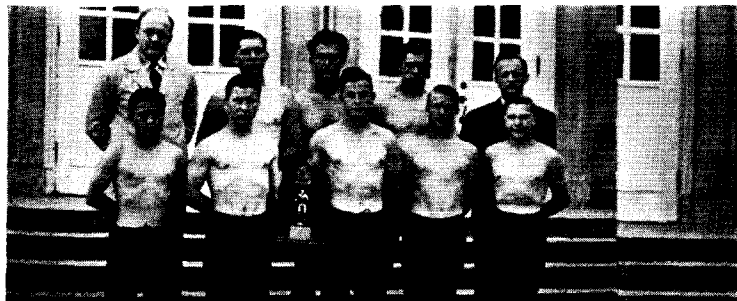

Front row—Oliver Hayashi Russell Fry Wilbur Goodie Clarence Terrill Kenneth St. John. Back row—Coach Ed. Whalley Stanley Weimer Warren Ullerich Henry Patterick Goodrich Walton.

GRAND JUNCTION (COLO.) HIGH SCHOOL.



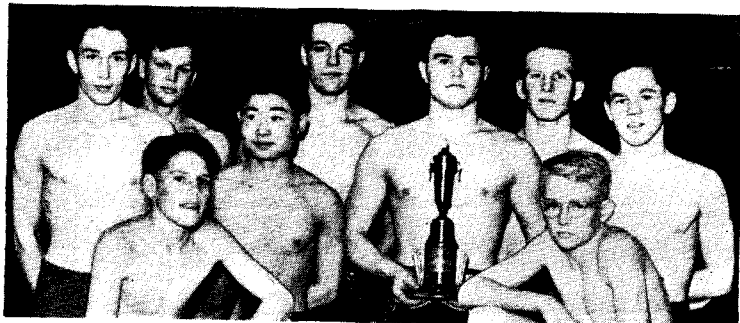

Front row—Wayne Snider Hill Jones. Row 2—Emmett Scott Leo Kawasaki Bill Beven Frank Pete.  
Back row—Omar Rhodes James Mulford Alvin Jones.

#### PACIFIC NORTHWEST INTERSCHOLASTIC CHAMPIONS.

### INTERSCHOLASTIC WRESTLING IN WASHINGTON

By William W. Foster, Camas (Wash.) High School.

Hill Military Academy of Portland, Oregon, won the Pacific Northwest championship tournament of 1938 in one of the most exciting competitions ever held in the Northwest. The result was not decided until the final bout of the tournament, and the latter a very close referee's decision.

Individual champions: 95 lbs., Wayne Snider (Salem); 105 lbs., Bill Jones (Oregon School for Blind); 115 lbs., Leo Kawasaki (Fife); 125 lbs., Frank Pete (Lincoln High, Tacoma); 135 lbs., Emmett Scott (Camas); 145 lbs., Alvin Jones (Hill M.A.); 155 lbs., Omar Rhodes (Camas); 165 lbs., James Mulford (Hill M.A.); 185 lbs., Bill Beven (Hill M.A.).

The tournament was very closely contested throughout, with twelve of the original fifteen schools competing in the semi-finals, while five of the schools were still represented in four different weight groups.

Thanks to the change in rules, which placed the greater emphasis on falls or near-falls as a determining factor in the results of matches, the spectators voiced loud praise of the change in type of wrestling.

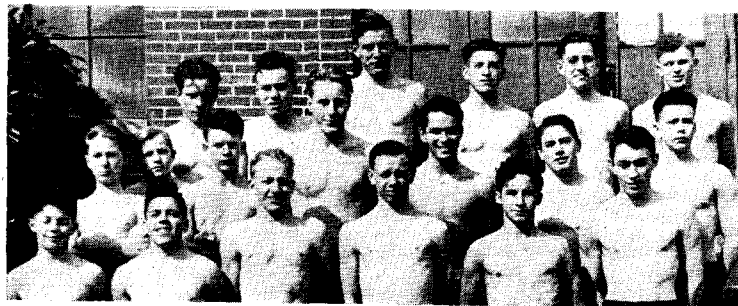

Front row—Mullincamp Dailey Gray Knode Sterm Scott. Row 2—Fine Hagenson D.Rhodes Eggebraaten Smith Krohn R.Rhodes. Back row—Parsons Martin Jensen Reynolds Ports O.Rhodes.

#### CAMAS (WASH.) HIGH SCHOOL.

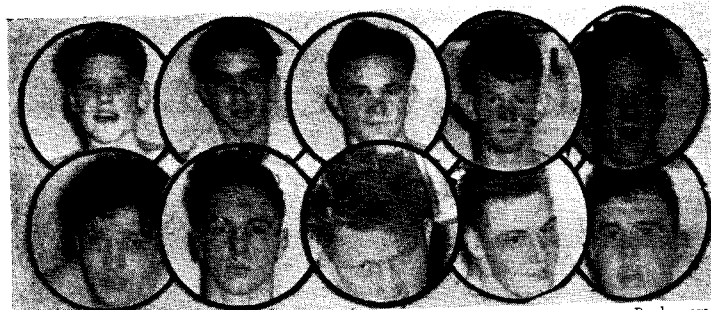

Front row—Gerald McCarthy Ed Miles Douglas Vagt James Mulford Bill Beven. Back row—Wayne Snider Louis Radford Ted Webb Don Buckley Alvin Jones.

#### INTERSCHOLASTIC CHAMPIONS OF OREGON.

### INTERSCHOLASTIC WRESTLING IN OREGON

By Vernon Gilmore, Salem High School.

The seventh annual Oregon High School A.A. tournament was held at Salem High School, March 4 and 5, 1938. There was an increase in the number of teams entered, bringing the total to fourteen. One hundred and thirty-three boys were entered in the first round, about forty more than in the previous year. As an example of the increase in wrestling interest, seven schools won titles in various weights, which shows that the technique of wrestling is becoming better uniformly.

Hill Military Academy of Portland won the championship, Tillamook placed second and Salem and Corvallis tied for third. Hill's victory broke the monopoly which Benson of Portland and Salem had enjoyed in the past. Benson, however, did not compete last season, due to a controversy between the Portland schools and the Oregon H.S.A.A. It was Hill's second year in the tournament and they had a fine squad, coached by Noel Franklin.

Individual winners: 95 lbs., Wayne Snider (Salem); 105 lbs., Louis Radford (Sandy); 115 lbs., Ted Webb (Corvallis); 125 lbs., Gerald McCarthy (Oregon City); 135 lbs., Don Buckley (Newberg); 145 lbs., Alvin Jones (Hill); 155 lbs., Ed Miles (Canby); 165 lbs., James Mulford (Hill); 185 lbs., Bill Beven (Hill); heavyweight, Douglas Vagt (Tillamook).

Most of the bouts during the tournament were won on falls, and it so happened that the boys meeting in the finals were so evenly matched that decisions were rendered in every case in the finals. This was done on the point basis and proved very popular as the crowd understood the points, and the decisions were just.



Front row—Jack Elwood Bob Baker Willie Paulus Bob Allen John Sugai Henry Tanaka Willie McCarroll. Row 2—Bob Boock George Barham Wayne Snider Roy Kaneko Hiroshi Shishido. Row 3—Asst Coach Tots Yada James Leedy Bill Huffman Ray Lutz Virgil Bolton (M). Back row—Dave Nyberg Herman Gremmer Eugene George Claude Swingle Tom Tandy Milton Hartwell Claude Kilgore Richard Cookins Coach Vern Gilmore.

#### SALEM (ORE.) HIGH SCHOOL.



## INTERSCHOLASTIC WRESTLING IN SOUTHERN CALIFORNIA

By Frank M. Crosby, San Diego High School.

The annual interscholastic wrestling tournament in Southern California has been sponsored by the California Interscholastic Federation for three consecutive years, which puts wrestling on a high plane with the many other sports from which boys in this state benefit. The major need of the sport in the state at present, however, is adequate leadership in the many splendid high schools.

The thirteenth annual interscholastic tournament was held at Inglewood High School, May 14, 1938, under the personal supervision of Wrestling Commissioner Roy H. Moore. The outstanding features of the competition were the aggressive type of wrestling as the result of the new method of picking winners and the more even distribution of first place medals among the competing schools than has been the case for many years. Whittier finished in first place, scoring 31 points; San Diego was a close second with 30, El Monte had 18, Inglewood 15, and Sherman Institute 12, with Luezing, Fullerton and Santa Ana trailing behind the leaders.

Individual winners: 95 lbs., Morales (EIM), won; Okine (WV), second. 105 lbs., Venegas (D), won; M.Padia (W), second. 115 lbs., Madamba (SD), won; Hernandez (W), second. 125 lbs., J.Padie (W), won; Foster (D), second. 135 lbs., Coppidge (SD), won; Lacey (W), second. 145 lbs., LaShell (W), won; Ferris (S), second. 155 lbs., Carro (S), won; Martin (SD), second. 165 lbs., Workman (EIM), won; Co-capt. Barnes (SD), second. 185 lbs., Bollin (SD), won; Ames (EIM), second.

J. Padia of Whittier was the only competitor to retain a championship from 1937. He won three titles and one second place in four years of competition. Barnes of San Diego won two titles and a second in three years of competition.

No organized league exists for dual meet competition for any of these schools, but many free lance dual meets are arranged and held each year. Sherman Institute and San Diego hold such a meet each year with twenty to thirty matches instead of the conventional nine. Sherman Institute competed in the

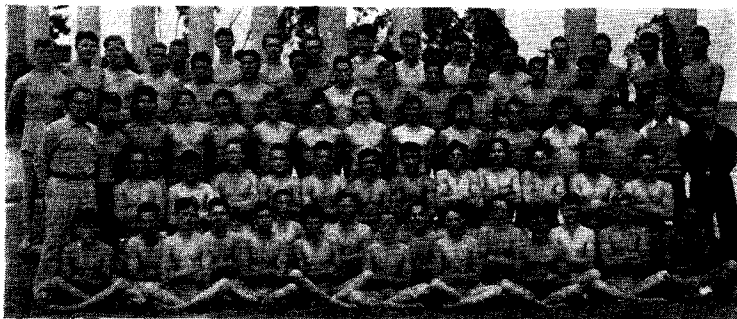

Front row—Murphy Maio Corrao Mayers Iarantino Madamba Brown Bottini des Plantes L.Scagliotti Gardner W.Anderson Asaro Chamberlain Donnelly Salvador. Row 2—German Morante Coppidge(Co-C) Ballenger Westover Mattei G.Rodriguez Navarro Harnetty Mathews S.Anderson E.Barnes. Row 3—Coach Crosby Tsuida Riverall Fee Karasawa Wheeler Higgins Lippincott Oakes Morishida Loperena Zimmerman Barnes (Co-C) R.Scagliotti(M) Wright(M). Row 4—Wahl Lewis Randall Maley La Lanne Martin Matsumoto Crivello Truax Aguilera Tom D.Rodriguez A.Rodriguez. Back row—Klingenberg Gibbs Randall Wunther Dahms Green Reed Amador Myers Kittredge Arata Fletcher. Vreeland.Photo

SAN DIEGO (CALIF.) HIGH SCHOOL.

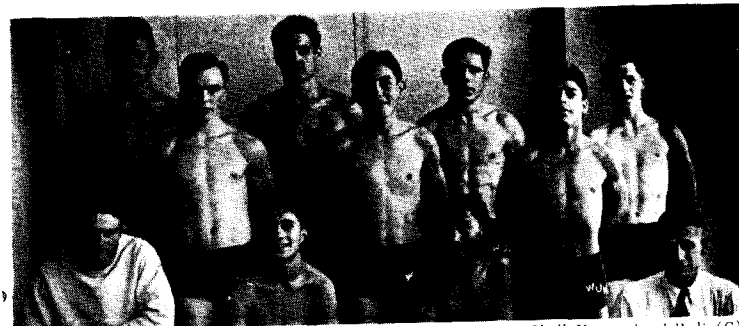

Front row—Damron(M) M.Padia Okine Coach Wegner. Row 2—LaShell Hernandez J.Padia(C). Back row—Christianson Charlton Miller Lacey.

WHITTIER (CALIF.) UNION HIGH SCHOOL.

Southern Pacific A.A.U. tournament, and after many weeks with the stiffest competition in the state finished in a tie for fifth place with U.C.L.A.

But the really important phase of wrestling activity in the high schools of Southern California is in intramural competition. Especially is this true at Whittier and San Diego, where the intramural programs are reaching more and more boys each year. At San Diego last season ninety-four boys were divided into eighteen classes for round robin competition in each class. It took three months to complete the tournament after school on one small mat. But in many respects it was the outstanding event on the physical education and athletic program at the school. The emphasis is on the mass program with just enough inter-school competition to keep interest high.

The California Interscholastic Federation does not permit athletic competition between the northern and southern parts of the state in any sports except track and field. And a special permit has to be secured before a California high school can compete in any sport with a school outside the state. The object is to eliminate expensive trips and overemphasis on competition. So we have to work out our own destinies in each section.



Front row—Premo Apalatea Martinez. Row 2—Sharpe Ferris Coach Townsend. Row 3—Bursion Dixon Curran Schriber Ames. Back row—Bonnicksen(M) Celeya Carro Rice AsstCoach D.Moore G.Moore.

SHERMAN INSTITUTE, RIVERSIDE, CALIF.

## INTERSCHOLASTIC WRESTLING IN NORTHERN NEW YORK

By John C. Cole, Coach Watertown High School.

Wrestling plays an important part in Northern New York athletics and is rapidly being introduced into those schools which have not as yet included it among their sports. In order to test the ability of wrestlers from all parts of the state an invitation interscholastic tournament is sponsored annually by St. Lawrence University, Canton, N. Y. In this meet the most competent from Southern New York and the Long Island district may compete with those chosen by elimination contests from Central and Northern New York.



Front row—Louis Vecpa Lyle Moran Joseph Wells Edward Corbett Anthony Sparacino Orle Green. Row 2—Wsrren Sponable(M) Peter Grieco Fred Hunt Charles Forshaw Bruce Otis Lawrence Kingsbury Coach John Cole. Cunningham, Photo

### WATERTOWN (N.Y.) HIGH SCHOOL.

In the fifth annual St. Lawrence tournament, held last March, the entry list comprised 110 wrestlers, representing fourteen schools. Mepham High School of Bellmore, Long Island, and Ithaca High School tied with 17 points each. Little Falls had 16 points, Gouverneur 15, Watertown 9, VanHornesville 6, Ogdensburg 2, Ellenburg 2, and Edwards 1. Altona, Canton, Chaucogay, Norwich and Richfield Springs failed to score. Individual winners—95 lbs., Curcio (G); 105 lbs., J. Pitelli (M); 115 lbs., Heinisch (I); 125 lbs., Feldmeyer (LF); 135 lbs., Powers (M); 145 lbs., Biffora (LF); 155 lbs., Frank (I); 165 lbs., Albee (I); unlimited, Sprague (G).

## INTERSCHOLASTIC WRESTLING ON LONG ISLAND, NEW YORK

Compiled by Sprig Gardner, Coach Mepham High School, Bellmore, N.Y.

High school wrestling made rapid advancement on Long Island during the past year, in both participation and spectator interest. On December 3 a wrestling forum was conducted at Mepham High School under the able direction of Coach William Sheridan of Lehigh University, Coach James Reed of Princeton and John Engle. More than 1200 parents and wrestlers from all parts of the Island were in attendance and many left with a changed attitude toward the sport.

Amityville and Mepham had the outstanding records in dual competition, remaining undefeated throughout the season. The meet between the two schools resulted in a 15-15 tie.

Three tournaments were conducted, the Mepham invitation, to which all Long Island High Schools were invited; the South Shore, restricted to members of the South Shore League, and the Suffolk interscholastics, limited to Suffolk County high schools. Results were as follows:

**Mepham Invitation** (130 entries)—Mepham 87, Amityville 74, Valley Stream 54, Bay Shore 52, Great Neck 45, Oceanside 42, Patchogue 42, Easthampton 36, Lawrence 35, Westhampton 32, Lynbrook 8, Sewanhaka 6, Long Beach 3. Individual winners—95 lbs., M. Pitelli (M); 105 lbs., J. Pitelli (M); 115 lbs., DeSant (P); 125 lbs., Lawrence (A); 135 lbs., Schold (VS); 145 lbs., Reeves (BS); 155 lbs., Benson (M); 165 lbs., Furey (BS); 175 lbs., Winter (M); 185 lbs., Krutsch (M).

**Suffolk Interscholastics** (112 entries)—Westhampton 29, Amityville 27, Bay Shore 27, Patchogue 12, Easthampton 8, Southampton, Bellport, Riverhead and Huntington failed to score. Individual winners—95 lbs., Rekowski (W); 105 lbs., Dorn (A); 115 lbs., Cromarty (A); 125 lbs., Fountain (W); 135 lbs., Whitlock (BS); 145 lbs., Smitzler (BS); 155 lbs., Pariente (W); 165 lbs., Furey (BS); 175 lbs., Smith (A).

**South Shore League** (121 entries)—Mepham 64, Valley Stream 26, Oceanside 22, Malverne 14, Lawrence 13, Lynbrook 11, Long Beach 9. Individual winners—95 lbs., M. Pitelli (Mep); 105 lbs., J. Pitelli (Mep); 115 lbs., Nafis (Mal); 125 lbs., Schultheiss (VS); 135 lbs., Bertucci (L); 145 lbs., Carpenter (O); 155 lbs., Schneider (VS); 165 lbs., Carol (LR); 175 lbs., Winter (Mep); 185 lbs., Krutsch (Mep).

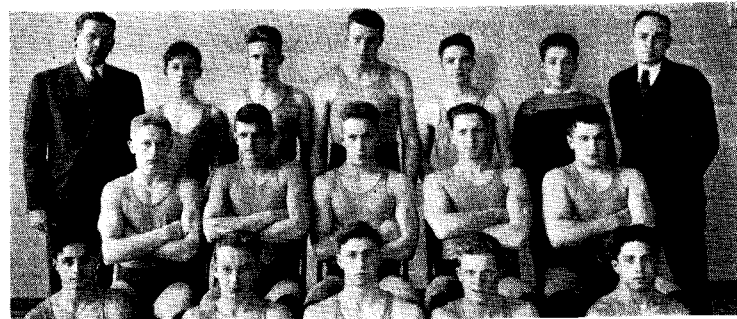

Front row—M. Pitelli Pelant Powers R. Moore J. Pitelli. Row 2—Schneider Benson Kammerer Winter Krutsch. Back row—Prin. S.H. Calhoun Hauck D. Moore Morton LoRusso Leiman(M) Coach F.D. Gardner.

WELLINGTON C. MEPHAM HIGH SCHOOL, BELLMORE (L.I.), N.Y.

## INTERSCHOLASTIC WRESTLING IN WESTERN PENNSYLVANIA

By H. A. Fischer, Beaver, Pa.

The third annual wrestling championships of the Western Pennsylvania Interscholastic Athletic League were held at Waynesburg College, March 11 and 12, 1938. One hundred fifty entries representing twenty-three schools competed in the two-day affair. The wrestling committee echoes the praise of the high school coaches and contestants due the Waynesburg college authorities for their splendid organization and efficiency in sponsoring this meet. From all standpoints it was the most successful championship event ever conducted by the league.

Canonsburg, coached by R. J. O'Connell, after an enviable season of dual meets, once more successfully defended its title. The point distribution was

much greater than it had been in previous tournaments and only in the final tally was the winner determined. The year also saw the inauguration of Pennsylvania state high school championships. The W.P.I.A.L., comprising District 7 of the Pennsylvania I.A.A., was permitted to enter the ten district champions in the state meet, which was held at Penn State College, March 18 and 19, 1938. Custer, Metzler and Ahwesh, who won in their respective classes in the W.P.I.A.L. tournament, attained additional honors by winning their events in the state championships. While district and team championships were not recognized in the state meet, it seemed an indication to the committee that wrestling in the W.P.I.A.L. compares favorably with the progress being made in the balance of the state.

Team point scoring in the W.P.I.A.L. championships was as follows: Canonsburg 33, Greensburg 27, Trafford 29, Dormont 11, Charnichsels 8, Norwin 6, Elizabeth 6, Ramsey 4, Waynesburg 2, Stowe 2, Sewickley Township 2, West Newton 1. Individual champions: 85 lbs., DeMarino (G); 95 lbs., Custer (C); 105 lbs., Phillips (D); 115 lbs., Puchany (C); 125 lbs., Pappert (D); 135 lbs., Metzler (G); 145 lbs., Valmassoni (C); 155 lbs., Paul (C); 165 lbs., Bitler (G); heavy-weight, Ahwesh (C).

#### WYOMING SEMINARY, KINGSTON, PA.

23—Columbia Frosh 13      14½—Syracuse Frosh 15½      21—Princeton Frosh 11  
31—F&M Acad 5            24—Cornell Frosh 6            17—Temple Frosh 9  
23—U of Pa JV 3            17—Lehigh Frosh 15



Front row—Coach R.E.Sparks Archer Puddington James Laggan Harry Croop. Row 2—Tom Eason Warren Tischler(C) William Mozur Robert Buntz Ed Kopicki Gene Zenier Robert Snyder(M). Row 3—Stanley Davies James Lurba Fred Miller Robert Conahay Robert Farley Robert Miles Norbert Lehman. Back row—John Kratz Robert Sheehan Jack Lurba Frank Estelle Ross Lapp Bruce Conahay James Davies Walter Staub Henry Gordon. Lazarus,Photo

WYOMING SEMINARY, KINGSTON, PA.

#### EIGHTH ANNUAL NORTH CAROLINA HIGH SCHOOL TOURNAMENT.

The eighth annual North Carolina high school tournament was again sponsored by University of North Carolina. Seven schools entered full teams, with Barium Springs retaining the team title that it has held for several years. Team scores:

Barium Springs, 44; Durham, 38; Greensboro, 26; High Point, 27; Salisbury, 15; Thomasville, 14; Charlotte, 3.



Front row—McGuinness V.Scopaticci(C) Pagano(Co-C) Schwartzreich W.Kuntz. Row 2—Gianunzio McClintock Kurz Kirchoff J.Scopaticci. Back row—Bleckman(M) Richenbach Hutchinson Prigoff R.Kuntz Coach E.J.Storey.

MAMARONECK (N.Y.) HIGH SCHOOL.

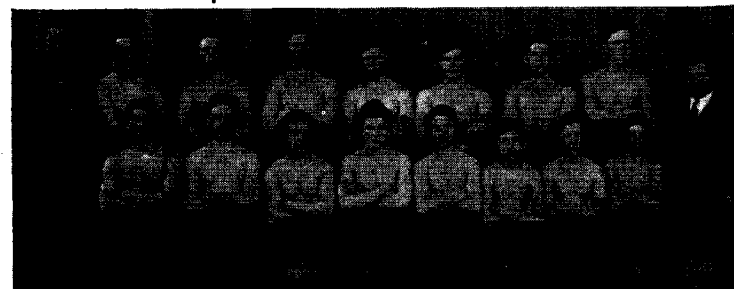

Front row—J.Collucci J.Breen F.Loowski R.Shannon H.Farrell S.Paterno M.Von Ohlen D.Valenti. Back row—Robert Ruff(M) R.Newman W.Benner K.Brown H.Tiemen J.Krip J.Fennell W.Wacker Coach R.Williams.

ROSELLE PARK (N.J.) HIGH SCHOOL.

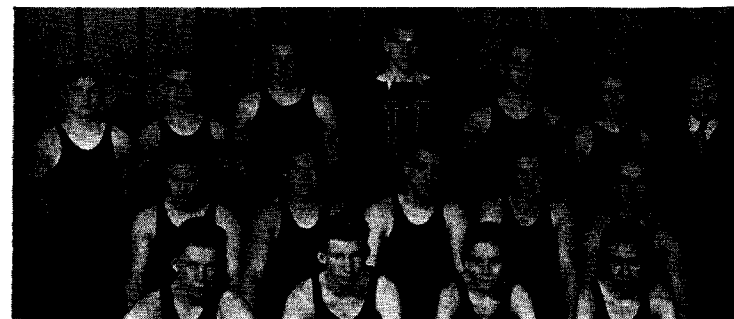

Front row—Isaksen Smith Wimmer Infeld. Row 2—Floster Kees Sverson Halsey Remaile. Back row—Adams Kocek Carralvant Floster(M) Levine Schaeffer Coach Ringler.

UNION (N.J.) HIGH SCHOOL

Gutkaiss.Photo

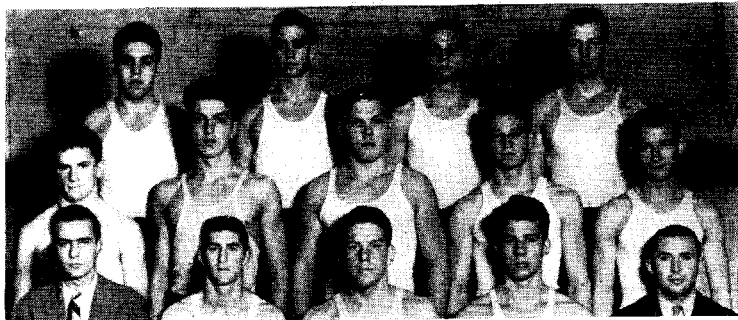

Front row—R.T. Moreland (M) C.D. Vail J.L. Jamison N.L. Shields Mr. Fred R. Kuhn (Coach).  
Row 2—R.E. Drowning (C) W.C. Dovey G.E. Chamberlin C. Lewis R.S. Greene. Back row—J.W. Hanson R.L. Headley R.P. Klopp H.H. Kreider.

#### MERCERSBURG (PA.) ACADEMY.

Wrestling is growing in the East and especially at Mercersburg, where it is the most popular sport. In the Lehigh Interscholastics Mercersburg topped Wyoming Seminary and Brooklyn Poly Prep, with 31 points, the team finishing with an undefeated season.

26—Carlisle YMCA 10	24—Gottysburg Frosh 6	24—Ecklin-Marsh Acad 6
35—Tome School 0	21—Lehigh Frosh 3	25—Navy Plebes 15
16—Penn State Frosh 14		

#### INTERSCHOLASTIC WRESTLING IN MARYLAND

In the Maryland state meet, six schools were entered. Baltimore City College carrying off honors by the margin of one point over Baltimore Polytechnic. Team scores: Baltimore City College 17½ points, Baltimore Polytechnic Institute 16½, McDonogh School 15½, Gilman School 14½, Severn School 8½, Patterson Park High School 2.

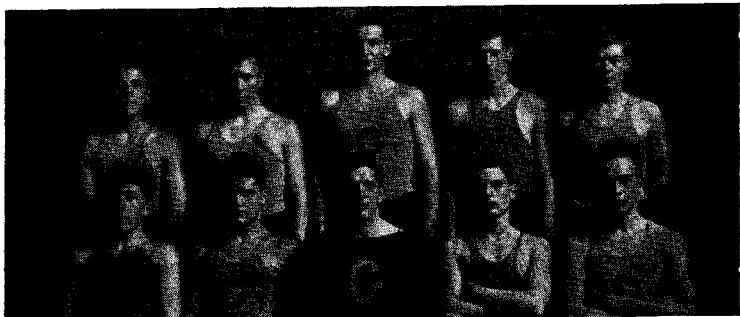

Front row—Robert Pickett Edward Supples William Legg Frank Beury Clarence Lovelace. Back row—Charles Bagley John Owens Jr. Taylor Birkhead Edward Murray Lenord Drennan Jr.

GILMAN COUNTRY DAY SCHOOL, ROLAND PARK, BALTIMORE, MD.

#### INTERSCHOLASTIC WRESTLING IN WEST VIRGINIA

By Frank M. Lough, Coach Weston High School.

Larger crowds attended all wrestling meets in West Virginia during the season of 1938 than ever before. At Harrisville the sport eclipsed both basketball and football in popular interest. Harrisville won the state championship, with East Fairmont second.

The new rules were well received, especially when referees broke completely with the oldtime advantage method of scoring. An exhibition meet was wrestled by Parkersburg and Harrisville at the Pennsboro sectional basketball tournament, which interested several schools in taking up the sport. Sportsmanship reached a new high, with four teams, Morgantown, East Fairmont, Parkersburg and Weston, ending in a tie on a ballot to determine the team showing the best sportsmanship during the season.

Outstanding men were: 95 lbs., Conrad, Harrisville; 105 lbs., Goff, Harrisville; 115 lbs., Bartholow, East Fairmont; 125 lbs., Betonte, East Fairmont, and Hall, Weston; 135 lbs., Vinson and Maston, Harrisville; 145 lbs., Manzo, Parkersburg; 155 lbs., Stalnaker, Weston, and Williams, Parkersburg; 165 lbs., Boone, Parkersburg; 185 lbs., Spordone, Parkersburg.



Front row—Conrad Goff Vinson Miller Liggett. Back row—Nutter (M) Schiffbauer Hyman Heffner Maston Boone Coach Creed Westfall.

HARRISVILLE (W.VA.) HIGH SCHOOL.

#### WRESTLING FOR BEGINNERS

By B. F. MOONEY, Ohio State University

Outlined Lessons on the Fundamentals of Wrestling  
With 63 Illustrations

Published by the M and M Publishing Co., Columbus, Ohio

Price \$1.00 c.o.d., or 85 cents in lots of one dozen or more

## American Amateur Wrestling Coaches Association

BY W. AUSTIN BISHOP, SECRETARY-TREASURER.

215 Hutchinson Gymnasium, University of Pennsylvania, Philadelphia, Pa.

Membership in the American Amateur Wrestling Coaches Association is open to all persons interested in teaching, coaching, or directing amateur wrestling activities in schools, colleges, athletic clubs, Y.M.C.A.'s and Y.M.H.A.'s. Yearly membership dues are one dollar, and may be forwarded to the office of the Secretary. The Coaches' News Bulletins, for which there is an increasing demand, are available only to members of the Association, to whom they are sent periodically free of charge.

As an institution for direct and concerted action in the interest of the sport of wrestling and its wholesome development, the Association has made many valuable contributions. Much important work remains to be done, however, and it is the hope of the Association that the athletic director and coach of every institution sponsoring wrestling activities may soon be affiliated with it. Old members are urged to invite their professional colleagues to membership.

The Secretary is eager to improve the quality of the Coaches' News Bulletin and will welcome suggestions from members. Meanwhile every member is asked to cooperate by prompt compliance with the following requests:

- (1) Place the name of the Secretary on the mailing list of your school or college paper. News items concerning wrestling will be of interest to others.
- (2) Prepare articles for publication in the News Bulletin. Select your own topic or choose one of the following subjects:

How to further improve amateur wrestling rules.  
 How to improve officiating.  
 Methods and materials in teaching wrestling.  
 Training and conditioning methods.  
 Ways of combating the harmful influences of professional wrestling.  
 How to stimulate interest in amateur wrestling.  
 How to minimize unnecessary hazards in wrestling.  
 Suggestions for the improvement and standardization of wrestling terminology.

The 1938 annual meeting of the Association was held in conjunction with the National Collegiate Championship meet at Pennsylvania State College Saturday, March 26, 1938, Charles Speidel presiding. Possible rules improvements were discussed at length, both in the general session and in the joint meeting with the Rules Committee which followed.

A committee was appointed to select the outstanding wrestler of the 1938 N.C.A.A. meet. The trophy annually provided by the Coaches Association was subsequently presented to Joe McDaniels of Oklahoma A.&M. College, who successfully defended the 118-lb. title.

A pleasant social gathering of the visiting coaches and officials was held Friday evening at the State College Country Club, the event having been planned by President Speidel and Dr. Schott, Director of Athletics at Pennsylvania State College.

The following officers were elected and duly installed for the year 1938-39: B. R. Patterson, Kansas State College, Manhattan, President; James Reed, Princeton University, Vice-President; W. Austin Bishop, University of Pennsylvania, Philadelphia, Secretary-Treasurer.

## Wrestling Officials

LIST OF WESTERN CONFERENCE AND FOURTH DISTRICT OFFICIALS.

Barker, R. W. .... Cornell College, Mount Vernon, Iowa.  
 Barnes, Dr. R. .... Cherokee, Iowa.  
 Barton, George .... Daily News, Minneapolis, Minn.  
 Beers, L. .... Purdue University, Lafayette, Ind.  
 Collins, Fendley .... Michigan State College, Lansing, Mich.  
 Dickerson, H. L. .... 1765 King Ave., Columbus, Ohio.  
 Drummond, John H. .... 2104 Board of Trade Building, Chicago, Ill.  
 Helgerson, F. .... Continental Illinois Bank, Chicago, Ill.  
 Hunter, Rolt. .... 19 South LaSalle St., Chicago, Ill.  
 Kallas, J. G. .... 845 South Wabash Ave., Chicago, Ill.  
 Keaton, Walter B. .... 514 North Harrison Street, Rushville, Ind.  
 Keen, Clifford .... University of Michigan, Ann Arbor.  
 Krough, "Red" .... Chicago University, Chicago, Ill.  
 Lookabaugh, Guy A. .... Grinnell College, Grinnell, Iowa.  
 Miller, H. .... Route No. 7, Lafayette, Ind.  
 Minot, George .... Orangeville, Ill.  
 Pinneo, Geo. M. .... Sheldon, Ill.  
 Righter, Pat .... Western Y.M.C.A., Detroit, Mich.  
 Robertson, Port .... University of Michigan, Ann Arbor, Mich.  
 Shave, Ed .... St. Paul Daily News, St. Paul, Minn.  
 Sievers, Harry .... East Waterloo High School, Waterloo, Iowa.  
 Stuteville, O. .... Northwestern University, Evanston, Ill.  
 Taylor, G. W. "Sec" .... Register and Tribune Bldg., Des Moines, Iowa.  
 Trenkle, R. L. .... Haywood Pub. Co., Lafayette, Ind.  
 Walden, Dewey .... 4325 Kenmore Ave., Chicago, Ill.  
 Watson, L. .... 1424 Dearborn Parkway, Chicago, Ill.

LIST OF MISSOURI VALLEY INTERCOLLEGIATE ATHLETIC ASSOCIATION AND FIFTH DISTRICT OFFICIALS.

Barker, R. W. .... Cornell College, Mount Vernon, Iowa.  
 Barnes, Dr. .... Cherokee, Iowa.  
 Bauman, Leon .... University of Kansas, Lawrence, Kans.  
 Beanblossom, F. Z. .... Cleveland, Okla.  
 Brannigan, George .... Kansas State College, Manhattan, Kan.  
 Campbell, John .... Merceline, Mo.  
 Chase, Ward .... Geary, Okla.  
 Clapp, Dr. R. G. .... University of Nebraska, Lincoln, Neb.  
 Clodfelter, Melvin .... High School, Ponca City, Okla.  
 Cochran, William .... University of Kansas, Lawrence, Kan.  
 Cook, Robert .... Hobart, Okla.  
 Crley, Louis .... Columbia, Mo.  
 Firkins, B. J. .... Ames, Iowa.  
 Fisher, Chas. .... University of Missouri, Columbia, Mo.  
 Flanders, Roger .... Stillwater, Okla.  
 Foreman, Marion .... Newkirk, Okla.  
 Gallagher, E. C. .... Oklahoma A.&M. College, Stillwater, Okla.  
 Geis, Clarence .... Enid, Okla.  
 Griffith, Art .... High School, Tulsa, Okla.  
 Griffith, Paul .... Edmond, Okla.  
 Grooms, Clair .... Davenport, Iowa.  
 Hove, L. W. .... High School, Geary, Okla.  
 Jacobson, G. C. .... Ponca City, Okla.  
 James, Dr. D. W. .... 811 South Surety, Des Moines, Iowa.  
 Keaton, Walter B. .... 514 North Harrison Street, Rushville, Ind.  
 Keen, Paul .... University of Oklahoma, Norman, Okla.  
 Kellogg, John .... Lincoln, Neb.  
 Keneen, Jos. .... Kansas City A.C., Kansas City, Mo.  
 Lookabaugh, Guy A. .... Grinnell College, Grinnell, Iowa.  
 Mallory, Lyman D. .... 1227 Walnut Street, Emporia, Kans.

Martin, Wayne .....Elk City, Okla.  
 Milam, Joe .....State Teachers College, Weatherford, Okla.  
 Moore, John J. O. ....Y.M.C.A., Kansas City, Mo.  
 Patterson, B. R. ....Kansas State Agricultural College, Manhattan, Kans.  
 Roberts, June .....Kansas State College, Manhattan, Kan.  
 Sappington, Guy .....Columbia, Mo.  
 Schroeder, E. G. ....University of Iowa, Iowa City, Iowa.  
 Smith, Gene .....Central State Thrs. College, Edmond, Okla.  
 Surbeck, Marion .....Southwestern State Thrs. College, Weatherford, Okla.  
 Taylor, G. W. "Sec" ..Register and Tribune Bldg., Des Moines, Iowa.  
 Umbach, Swede .....Fairfax, Okla.  
 Wallace, Polly .....Ada, Okla.  
 Young, Fowler .....Princeton, Mo.

## LIST OF SOUTHERN OFFICIALS.

Bailey, W. F. ....Physical Director, High Point Y.M.C.A., High Point, N. C.  
 Drennan, John .....North Carolina State College, Raleigh, N. C.  
 Quinlan, P. H. ....University of North Carolina, Chapel Hill, N. C.  
 Schreiber, William ..New Orleans Athletic Club, New Orleans, La.  
 Tilson, Tex .....Duke University, Durham, N. C.  
 Voiles, Carl .....Duke University, Durham, N. C.  
 White, Joel B. ....Y.M.C.A., Atlanta, Ga.

## LIST OF NEW ENGLAND (FIRST DISTRICT) OFFICIALS.

Anderton, Ralph G. ...320 Grand St., Providence, R.I.  
 Bishop, W. Austin ...Univ. of Pennsylvania, Philadelphia.  
 Bishop, Ben .....Lehigh University, Bethlehem, Pa.  
 Charon, Ben .....Broad Street Y.M.H.A., Philadelphia, Pa.  
 Clark, Harry .....Springfield College, Springfield, Mass.  
 Coe, David E. ....St. Mark's School, Southboro, Mass.  
 Cole, Richard K. ....Brown University, Providence, R.I.  
 Elder, Haskell P. ....Springfield College, Springfield, Mass.  
 Engel, John A. ....48 Washington Ave., Stamford, Conn.  
 Erich, Herbert .....59 Dana St., West Haven, Conn.  
 Gallagher, Clifford J..Lafayette College, Easton, Pa.  
 Hingston, Charles ...Tufts College, Medford, Mass.  
 Holobaugh, S. S. ....Manheim, Pa.  
 Jenness, E. L. ....Univ. of Pennsylvania, Philadelphia, Pa.  
 Johnson, Pat O. ....50 Bailey Ave., Watertown, Mass.  
 Klein, Arthur .....692 Parker St., Roxbury, Mass.  
 Leathers, R. K. ....Junior High School, Cranston, R. I.  
 Lehman, Wilbur B. ....Cheltenham High School, Elkins Park, Pa.  
 Mather, George .....Boston Herald, Boston, Mass.  
 Myerson, George .....91 Sewall Ave., Winthrop, Mass.  
 O'Donnell, Edward ..Yale University, New Haven, Conn.  
 Pennock, E. W. ....Springfield College, Springfield, Mass.  
 Rae, Thomas .....South Hadley, Mass.  
 Ricks, Jay .....Massachusetts Institute of Technology, Cambridge, Mass.  
 Rousseau, E. E. ....Hillside Ave., Holyoke, Mass.  
 Rudert, J. R. ....Warwick High School, Apponaug, R. I.  
 Ruggeri, Sam .....Tufts College, Medford, Mass.  
 Sarceant, Bliss P. ....Springfield College, Springfield, Mass.  
 Smith, Charles .....Swarthmore, Pa.  
 Spittler, Paul .....517 West 16th St., New York, N.Y.  
 Woodward, Stuart A. .9 Rose Garden St., Pawtucket, R.I.

## LIST OF EASTERN (SECOND DISTRICT) OFFICIALS.

Appleton, Lloyd O. ...U.S. Military Academy, West Point, N.Y.  
 Bickerhoff, Charles B..Dormont Public Schools, South Hills Branch, Pitts-  
 Bohn, Dr. J. Lloyd ..2444 West 78th Ave., Philadelphia, Pa.                     burgh, Pa.  
 Cann, W. E. ....Supervisor Phy. Educ., Public Schools, Elizabeth, N. J.  
 Finkelman, Dr. Ellis .6218 Wayne Ave., Philadelphia, Pa.

Horn, George G. ....215 East Penn St., Germantown, Pa.  
 Horner, Frank .....508 West 114th St., New York City.  
 Johnson, Howard ...Pennsylvania State College, State College Pa.  
 Lehman, W. B. ....Cheltenham High School, Elkins Park, Pa.  
 Lewis, R. B. ....1324 Prospect St., Bethlehem, Pa.  
 Morton, Lt. D. W. ....17 East Albermarle Ave., Lansdowne, Pa.  
 Osterman, J. K. ....Pine Grove Furnace, Pa.  
 Quimby, Neal F. ....64th St. and Malvern Ave., Philadelphia, Pa.  
 Reimer, George E. ...Cornwells Heights, Pa.  
 Rymer, Ralph W. ....222 West Montgomery Ave., Haverford, Pa.  
 Saltzman, William Y.6225 Sydenham St., Philadelphia, Pa.  
 Shanker, M. W. ....33 Crook Ave., Brooklyn.  
 Smith, Charles S. ....7320 Anster St., Forest Hills, Long Island, N.Y.  
 Spittler, Paul .....517 West 16th St., New York, N.Y.  
 Storey, Edward J. ...Mamaroneck Schools, New York.  
 Thrush, Murl .....New York A.C., New York, N.Y.  
 Wolcott, Mark W. ....3733 Spruce St., Philadelphia, Pa.  
 Wolfgang, Roy W. ....419 Elizabeth Manor, Upper Darby, Pa.

## LIST OF OHIO OFFICIALS.

Begala, Joe .....Kent State University, Kent, Ohio.  
 Busha, Del .....Board of Education, Cleveland, Ohio.  
 Griffith, J. G. ....West Technical High School, Cleveland, Ohio.  
 Hawk, Jr., F. E. ....Stow, Ohio.  
 Keller, Arch. ....Juvenile Court Bldg., Cleveland, Ohio.  
 Kraft, Ray T. ....South High School, Cleveland, Ohio.  
 Lukens, Clive .....c/o Sunny Dell R.F.D., Kent, Ohio.  
 Olson, Thor .....Ohio University, Athens, Ohio.  
 Scott, Fred .....c/o Kent State University, Kent, Ohio.  
 Sharer, Claude .....Case School of Applied Science, Cleveland, Ohio.  
 Tabor, Joseph .....R.F.D., Kent, Ohio.

## The Official Bishop Wrestling Record Book Gives You—

Carefully ruled forms for the essential items of every bout in every meet,  
stoutly bound for a season's service in the field.

Detachable triplicate forms for the press reports.

A bout-by-bout scoring device.

Forms for compiling the Individual and Team Records as the season  
advances.

A system of permanent records for the wrestling team.

Price, 50 cents.

W. AUSTIN BISHOP, University of Pennsylvania, Philadelphia, Pa.

---

---

*A New Book on Wrestling*



**FREE-STYLE  
WRESTLING**

(Spalding's Athletic Library No. 259)

*By*

**W. AUSTIN BISHOP**

Coach of Wrestling and Assistant Professor,  
Department of Physical Education, University of Pennsylvania

A complete, concise and up-to-date book of instruction on the art of Wrestling. Text profusely illustrated with over sixty photographs similar to those shown on opposite page.

*Price 50 cents*

**AMERICAN SPORTS PUBLISHING COMPANY,  
NEW YORK**

---

---

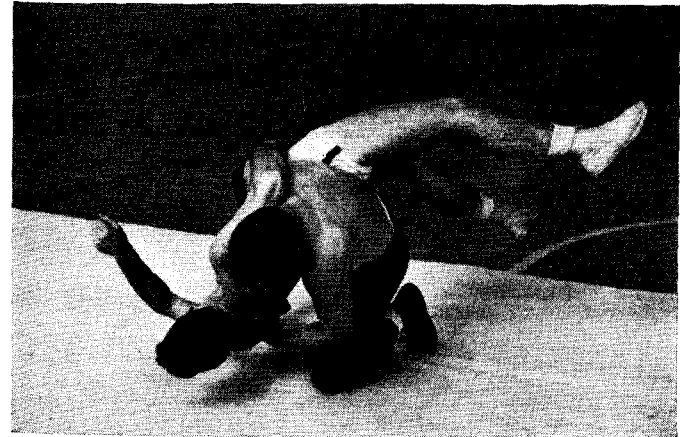
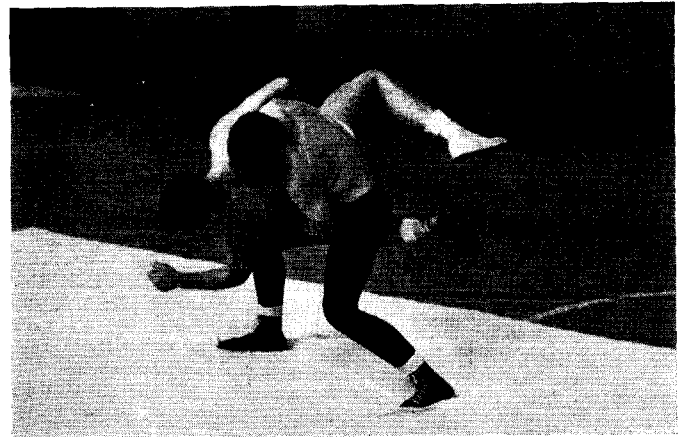

# OFFICIAL SPORTS ANNUALS

IN THE

## SPALDING ATHLETIC LIBRARY

With Approximate Date of Publication

- No. 322. OFFICIAL BASE BALL GUIDE.....March 35c.
- No. 320. OFFICIAL FOOT BALL GUIDE.....July 35c.
- No. 427. OFFICIAL GUIDE NATIONAL FOOTBALL LEAGUE Sept. 25c.
- No. 408. NATIONAL COLLEGIATE A.A. SOCCER GUIDE...October 25c.
- No. 470. OFFICIAL BASKET BALL GUIDE.....September 25c.
- No. 432. OFFICIAL A.A.U. BASKETBALL GUIDE.....October 25c.
- No. 491. N.C.A.A. INTERCOLLEGIATE SWIMMING GUIDE November 25c.
- No. 492. NATIONAL COLLEGIATE A.A. ICE HOCKEY GUIDE Yearly 25c.
- No. 357. OFFICIAL TENNIS GUIDE.....April 35c.
- No. 428. OFFICIAL VOLLEY BALL RULES.....Yearly 25c.
- No. 418. NATIONAL COLLEGIATE A.A. LACROSSE GUIDE..Yearly 25c.
- No. 400. OFFICIAL ATHLETIC ALMANAC.....January 25c.
- No. 411. NAT. COLLEGIATE A.A. TRACK AND FIELD GUIDE Jan. 25c.
- No. 429. NATIONAL COLLEGIATE A.A. WRESTLING GUIDE Yearly 25c.
- No. 412. SOFTBALL GUIDE .....April 25c.

For sale at all sporting goods stores or may be obtained direct from the publishers, American Sports Publishing Company,  
115 Fulton Street, New York, N. Y.

# Wrestling MATS

## COMBINATION MAT OUTFITS

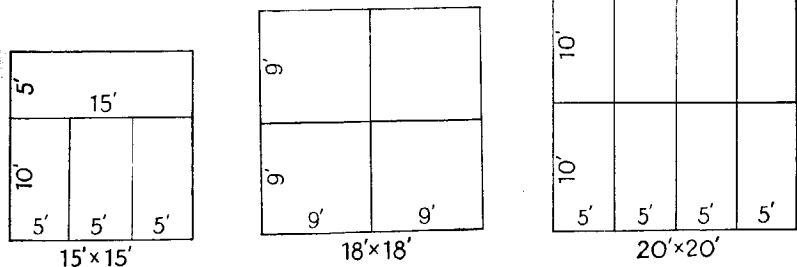

## GYM MATS

**COVER**—21 oz. white duck.  
**FILLER**—Hair felt. Burlap reinforced throughout entire mat.  
**SEWING**—Heavy waxed linen thread.  
**TUFTING**—Closely tufted with special, extra heavy waxed cord.  
**SEAMS**—Inverted seams. Double sewed throughout.  
**HANDLES**—Either sewn or riveted (we recommend double sewing). Handles of double 30 oz. white duck are attached to double side walls of mat in any location desired. Sq. Ft.

- 4433-25. 1 in. thickness.....\$0.60
- 4433-26. 2 in. thickness..... .80
- 4433-27. 3 in. thickness..... 1.00

The following mats are the same as the 4433-25, 4433-26, 4433-27 except made with 15 oz. white duck covers. Sq. Ft.

- 4433-28. 1 in. thickness.....\$0.65
- 4433-29. 2 in. thickness..... .75
- 4433-30. 3 in. thickness..... .95

## MAT HANGERS

- 4433-54. A sturdy, swinging hook made to accommodate 4 mats....\$3.00

**COVER**—21 oz. white duck.  
**FILLER**—Genuine Ozite hair felt.  
**SEWING — TUFTING — SEAMS — HANDLES.**

- Same as 4433-25, 4433-26, 4433-27. Sq. Ft.
- 4433-31. 1 in. thickness.....\$0.75
  - 4433-32. 2 in. thickness..... 1.00
  - 4433-33. 3 in. thickness..... 1.20

The following mats are the same as the 4433-31, 4433-32, 4433-33 except made with 15 oz. white duck cover. Sq. Ft.

- 4433-41. 1 in. thickness.....\$0.75
- 4433-42. 2 in. thickness..... .95
- 4433-43. 3 in. thickness..... 1.20

## MAT COVERS

These covers overlap 2 feet all around and lace on under side through grommet eyelet (lacing rope not furnished); In figuring cost add 2 feet to both dimensions of mat. Example 4 x 5 mat requires a 6 x 7 cover. Specify size of cover, not size of mat. Sq. Ft.

- 4433-69. 10 oz. canvas.....\$0.10
- 4433-70. Canton flannel..... .15
- 4433-71. Rubberized duck. .... .20



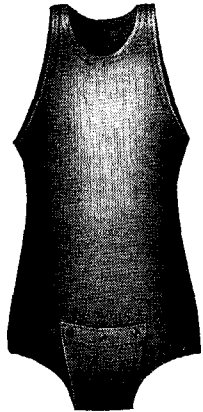

53-810

## Wrestling SHIRTS

- 53-810.** A new idea in shirts. Rayon face for slip, zephyr weight worsted yarn back. A fine shirt for appearance and wear. Supporter attachment, button front. . . Ea., **\$3.55**
- 53-700.** All worsted. Medium weight. . . . . Each, **\$2.75**
- 53-710.** All worsted. Medium weight. Supporter attachment. . . . . Each, **\$3.50**
- 53-300.** All rayon knit. Light in weight. The rayon gives it a slippery surface. . . . . Each, **\$2.35**
- 53-310.** All rayon knit. Light in weight, but plenty of sparkle and the rayon gives it a slippery surface. Supporter attachment. . . . . Each, **\$3.25**

## Wrestling Accessories

### WRESTLING HEAD HARNESS

**4435-08.** Brown leather head band. Leather ear pieces covered on the inside with Air-Lite rubber foam. Leather head strap from front to back and from side to side. Elastic at back gives proper adjustment for head size. Elastic chin strap with adjustable snap fastener. . . . . Each, **\$3.70**

### SKIPPING ROPE

**4435-50.** Skipping Rope. Heavy woven rope with rubberized finished handles and swing ring which allows free turning. In 9 feet length. . . Each, **\$1.00**

### WRESTLING SHOES

**4437-03.** Wrestling Shoe. High cut shoe of fine grade, black leather. Very pliable. Laced to toe. Special corrugated non-slip rubber soles. A sturdy, light weight shoe for fast work. . . . . Pair, **65c.**

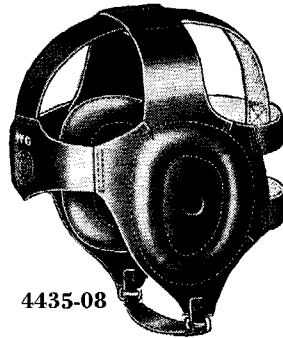

4435-08



4437-03

## Designed for WRESTLERS

### TRUNKS



4436-87

All trunks are made on special order and can be supplied in all regular athletic colors. Give waist measurement only.

**4436-81.** A new, high cut back with saddle seat and fashion cut front. A fine fitting trunk, made of heavy weight all worsted knit. . . . . Each, **\$3.20**

**4436-83.** A new, high cut back with saddle seat and fashion cut front. A fine fitting trunk, made of medium weight all worsted knit. . . . . Each, **\$3.00**

**4436-85.** A new, high cut back with saddle seat and fashion cut front. A fine fitting trunk, made of combination knit, heavy weight worsted and cotton. . . . . Each, **\$3.00**

### TIGHTS

**4436-60.** Championship. Heavy worsted. Full length tights with feet. . . . . Each, **\$8.35**

**4436-61.** Wrestling tights. All worsted, heavy weight, durable close knit. Double knit knee pad, either unattached or sewn on. . . . . Each, **\$8.65**

**4463-63.** Tights. All worsted, medium weight, tight twist knit. Double knit knee pads unattached or sewn on. . . . . Each, **\$9.00**

**4436-65.** Combination yarn (worsted for softness, cotton for wear), heavy weight. Very strong knit. Knit knee pads sewn on or unattached. . . . . Each, **\$8.00**

**4436-67.** High lustre rayon knit face, backed with all worsted. Its strong, slippery surface is a new idea in wrestling tights. Double knit knee pad sewn on or unattached. . . . . Each, **\$7.50**

**4436-69.** Knit of colorfast cotton yarn, soft, strong and durable. Double knit knee pads sewn on or unattached. . . . . Each, **\$3.95**

All trunks, tights and shirts are made on special order and can be supplied in all regular athletic colors. In ordering tights give waist and inseam measurements. On tights with feet state size of hose worn. Knee length trunks give waist measurement only. State whether shirts are to be with or without supporter attachment and give chest measurement.



4436-67

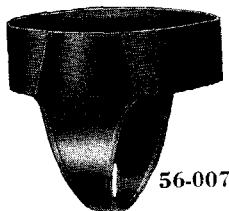

56-007

# Wrestling SUPPORTERS

**56.007.** Spalding wrestling supporter. Black elastic. 6 inch waist band of elastic webbing. Sack of soft knit material with bound edges.

Each, **\$1.50**

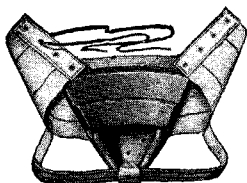

56-017

**56.017.** Taylor Foulproof Protector. Duraluminum cup, covered back and front. Foam rubber lined. 3-inch elastic waistband; 1-inch leg straps. Approved in N. Y., N. J., MASS., PA., MD., WIS., and other states. Large, medium, small. . . . . Each, **\$7.80**

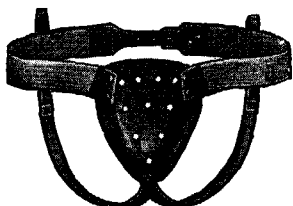

56-018

**56.018.** Taylor Foulproof Duraluminum Cup. Covered with molded foam rubber. 3-inch elastic waistband, laced back. . . . . Each, **\$5.00**

**56-036.** Molded Cast Aluminum Cup. Rubber edging vulcanized to the cup. . Each, **\$2.80**

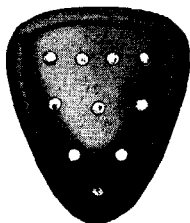

56-036

**56-053.** Supporter. Made with 3-inch waistband. Pouch made of soft cotton jersey weave to hold all types of protective cups. . . Ea., **85c.**

