

*Official* **NCAA**

*1961* **Yearbook** *Guide*

**1961**

**Dave Auble**  
**Cornell University**

**Cornell**

# Rawlings®

ATHLETIC EQUIPMENT

*"The Finest In The Field!"*

**THE OFFICIAL**  
National Collegiate Athletic Association  
**WRESTLING GUIDE**

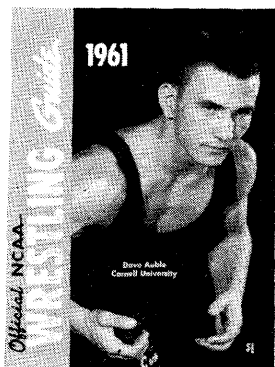
*The Official Rules Book*  
**AND RECORD BOOK OF**  
*Collegiate and Scholastic Wrestling*

**1961**

**Raymond E. Sparks, Editor**

*produced and distributed by*

**THE NATIONAL COLLEGIATE ATHLETIC BUREAU  
NEW YORK**



**ON THE COVER:** Dave Auble of Cornell, who grew up near the Ithaca campus, captured two National and three Eastern titles and wound up the Outstanding Wrestler in the 1960 National Collegiate Championships. He was also 1959 Pan American champion and breezed to a U.S. Olympic squad berth by pinning 9 of 11 opponents in the trials. A Business major, he had a 51-1 collegiate record and a 75-2 won-lost slate in all competition.

**PUBLISHED BY:** The National Collegiate Athletic Association, under the supervision of its Publications Committee:

James V. Gilloon, Jr., New York U., *Chairman*

James W. Liebertz, U. S. Merchant Marine Academy

George L. Shiebler, Eastern College Athletic Conference

**PRODUCED AND DISTRIBUTED BY:** The official service organization of the NCAA, the National Collegiate Athletic Bureau:

Homer F. Cooke, Jr., *Director*

Jack Waters, *Assistant Director*

Chris Erles, *Associate Editor*

Danny Hill, *Development Director*

Jim Holmes, *Associate Editor*

Steve Boda, *Research Director*

Marie Montana, *Production Manager*

**ADDRESS ALL CORRESPONDENCE TO:** The National Collegiate Athletic Bureau, Box 757, Grand Central Station, New York 17, N. Y., on editorial and sales matters. Permission to reprint material appearing in *The NCAA Wrestling Guide*, either wholly or in part, in any form whatsoever, must be secured in writing from the publisher.

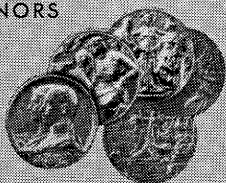
**ADVERTISING REPRESENTATIVES:** Spencer Advertising Company, Inc., 271 Madison Avenue, New York 16, N. Y.

COPYRIGHT, 1960, BY THE NATIONAL COLLEGIATE ATHLETIC ASSOCIATION

PRINTED IN THE UNITED STATES OF AMERICA



WINNER OF 10 WORLD'S FAIR GRAND PRIZES,  
28 GOLD MEDALS,  
HIGHEST OBSERVATORY HONORS  
FOR ACCURACY



*Longines*

THE WORLD'S MOST HONORED WATCH

OFFICIAL WATCH FOR ALL

N. C. A. A.

CHAMPIONSHIPS

*Longines Watches are official for timing  
world records for all sports throughout the world*



STANDARD OF EXCELLENCE ON FIVE CONTINENTS

# SAND KNIT

**Athletic Knitwear and Clothing**

**THE FINEST IN WRESTLING UNIFORMS**



## SHIRTS

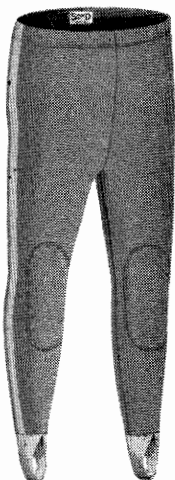
- Worsted and Cotton
- Stretch Nylon
- Durene
- Nylon-Durene  
Supporter Style



## TRUNKS



## TIGHTS



- Professional Saddle Seat**  
Elastic in Legs and Waist
- All Two-Way Stretch
  - Reinforced Nylon Ribett
  - Stretch Nylon

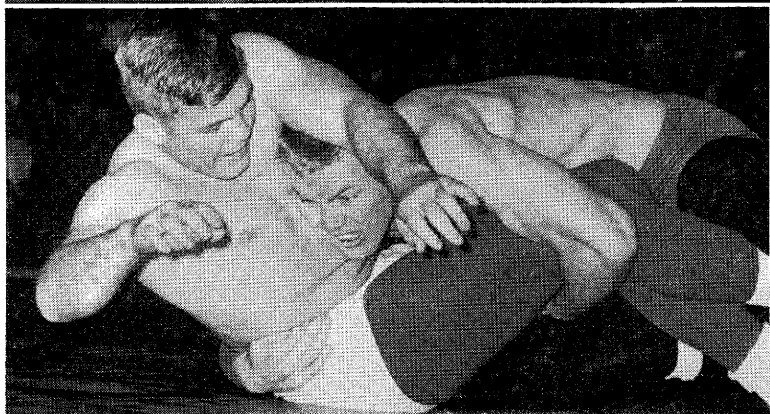
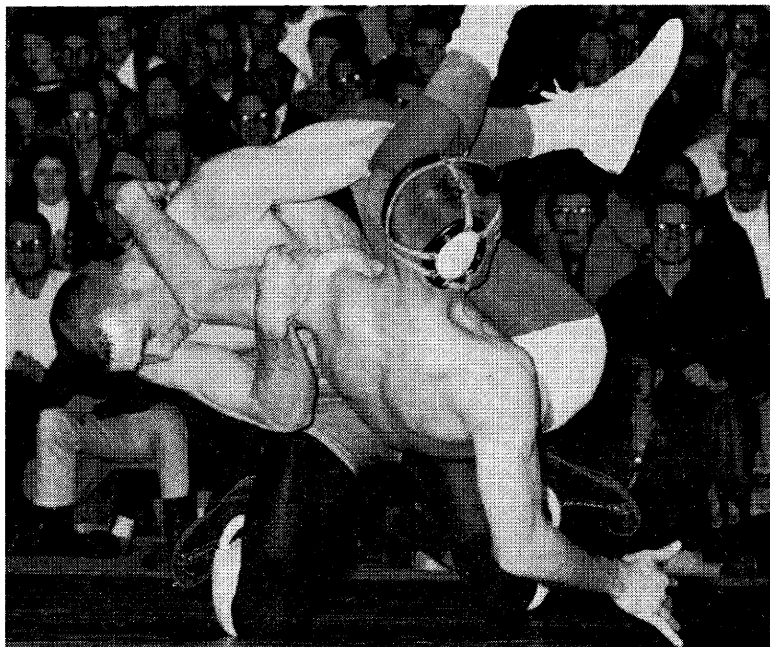
- Worsted Cotton Heavy  
Weight
- Stretch Nylon
- Durene
- Cotton Heavy Weight
- Reinforced Nylon Ribett
- Elastex Ribett

**SEE YOUR SAND DEALER OR WRITE  
DIRECT FOR DESCRIPTIVE FOLDER**

**SAND KNITTING MILLS CORP.**  
**BERLIN, WISCONSIN**

# Contents

	PAGE
NATIONAL COLLEGIATE CHAMPIONSHIPS .....	7
<i>by Joe F. Blair</i>	
COLLEGIATE REVIEWS:	
EASTERN IWA <i>by George L. Shiebler</i> .....	13
NEW ENGLAND IWA <i>by Dick Kipperman</i> .....	13
MIDDLE ATLANTIC STATES CAC <i>by Arthur J. Hoover</i> .....	14
WILKES COLLEGE OPEN <i>by Arthur J. Hoover</i> .....	14
PENN STATE COLLEGES TOURNAMENT <i>by S. G. Jacobs</i> .....	14
SOUTHEASTERN INTERCOLLEGIATE CHAMPIONSHIPS <i>by John A. Davis</i> .....	15
SOUTHERN CONFERENCE TOURNAMENT <i>by Charlie Parker</i> .....	15
ATLANTIC COAST CONFERENCE <i>by Frank W. Finger</i> .....	15
MASON-DIXON TOURNAMENT .....	17
CIAA TOURNAMENT <i>by Robert N. Gardner</i> .....	17
BIG TEN CHAMPIONSHIPS .....	17
MID-AMERICAN CONFERENCE CHAMPIONSHIPS <i>by Joe Begala</i> .....	17
OHIO CONFERENCE <i>by Ted Gathany</i> .....	19
WHEATON COLLEGE INVITATIONAL TOURNAMENT <i>by Dave Belman</i> .....	19
COLLEGE CONFERENCE OF ILLINOIS <i>by Al Hanke</i> .....	19
PRESIDENTS' ATHLETIC CONFERENCE <i>by Robert L. Murphy</i> .....	19
IOWA COLLEGIATE CONFERENCE <i>by Warren G. Berg</i> .....	21
IOWA TEACHERS INVITATIONAL <i>by George Wine</i> .....	21
INDIANA LITTLE STATE TOURNAMENT <i>by Don Tourtelot</i> .....	21
FOUR-I CHAMPIONSHIPS <i>by Claude Sharer</i> .....	21
MIDWEST COLLEGE CONFERENCE <i>by Randy Haase</i> .....	22
NORTHERN STATES COLLEGE CONFERENCE <i>by R. G. Macias</i> .....	22
NORTH DAKOTA STATE COLLEGE TOURNAMENT .....	22
BIG EIGHT CHAMPIONSHIPS <i>by Otis Wile</i> .....	23
ROCKY MOUNTAIN CONFERENCE <i>by John W. Hancock</i> .....	24
MOUNTAIN STATES ATHLETIC CONFERENCE <i>by Marvin G. Hess</i> .....	24
PACIFIC COAST INTERCOLLEGIATE TOURNAMENT .....	24
CALIFORNIA JUNIOR COLLEGE CHAMPIONSHIPS .....	24
IDAHO JUNIOR COLLEGE CONFERENCE <i>by Carl Bair</i> .....	25
EASTERN CALIFORNIA CONFERENCE TOURNAMENT .....	25
NAIA TOURNAMENT <i>by S. G. Jacobs</i> .....	25
1960 DUAL MEET RECORDS .....	26
SCHOLASTIC REVIEWS .....	29
RULES SECTION:	
NCAA WRESTLING RULES COMMITTEE .....	53
INDEX TO RULES .....	54
MAJOR RULES: CHANGES .....	55
OFFICIAL NCAA WRESTLING RULES .....	56
PENALTY CHART .....	78
SUPPLEMENTARY MODIFICATIONS FOR INTERSCHOLASTIC WRESTLING .....	85
REFEREES' SIGNALS .....	89



**BULLDOGGING COWBOYS TOPPLE SOONERS:** Top—Oklahoma State's Bob Wilson bounces Larry Gregory of Oklahoma to mat during meeting of state archrivals. Wilson won 4-1 decision in 147-pound class. Bottom—Wilson's OSU teammate Ronnie Chinton, national runnerup at 167 pounds, ties up Sooner Sid Terry after one of six takedowns Cowboy scored in 14-12 decision. State handed Oklahoma Sooners' only two dual meet losses.

# National Collegiate Championships

By **JOE F. BLAIR**

*Sports Publicity Director, University of Maryland*

The National Collegiate Wrestling Championships continued their record-breaking trend of recent years in the 30th annual tournament at the University of Maryland.

For the first time in tournament history, which dates back to 1928, six sessions were required to handle the 269 matches. A record-breaking 81 institutions entered 266 individuals and 219 men representing 78 institutions actually competed. Forty-nine schools shared in the team scoring.

Oklahoma led by a single point at the end of the quarterfinals but clinched its fifth national title in the consolations. The Sooners captured three individual titles for the first time in the school's history, and for the first time in 32 years Oklahoma State was denied a champion.

Iowa State finished second for the third consecutive year edging out Wyoming. Iowa University and Oklahoma State, the defending champion, gave the Mid-West the first five team places.

Little Lock Haven (Pa.) Teachers with only three entries led the Eastern teams with 25 points. Penn State and Pittsburgh followed.

The Mid-West claimed 6 of the individual champions and had 11 of the 20 finalists. However, Dave Auble of Cornell retained some Eastern prestige by winning his second 123-pound title and was voted the outstanding wrestler.

John Baum, Michigan State's heavyweight, had the fastest fall of the tournament when he pinned Jim Sierk of Rutgers in 1:45 of his first match.

Roy Conrad 177-pounder from Northern Illinois was the surprise of the tournament as he topped Dave Campbell of Oklahoma 14-13. Conrad won his first four matches by three falls and a 9-0 decision. His point time advantage was the margin in the match.

The three defending champions retained their crowns and a runner-up, along with two fourth-place finishers from last year, captured titles.

Elliott Simons of Lock Haven won the 115-pound title on a unanimous decision after his reversal with 49 seconds left in overtime gained him a tie. Dick Wilson of Toledo was runner-up for the second consecutive year.

Auble and Stanley Abel of Oklahoma retained their 123 and 130-pound titles, each winning his second championship. Larry Lauchle of Pittsburgh, the 123-pound runner-up last year, was the runner-up to Abel.

Les Anderson won his second title for Iowa State with his 137-pound championship. He was the 130-pound winner in 1958, and runner-up to Abel in 1959. Teammate Larry Hayes won his second consecutive title, moving up to the 147-pound class. Jerry Frude of Wyoming was the runner-up for the second time.

Art Kraft of Northwestern, seeded eighth, topped Thad Turner of Lehigh for the 157-pound title.

Dick Ballinger became Wyoming's first national champion as he decisioned Ronnie Clinton of Oklahoma State.

Oklahoma won both the 191 and heavyweight titles with George Goodner and Dale Lewis taking low-scoring decisions.

Although Maryland's grapplers were ousted early, eliminating local interest, a record crowd of 22,900 saw the six sessions. The 6,800 total for Saturday's finals is also believed to be a single-session record.

A travelling record was set when 7 Pacific Coast schools competed in the tournament. These included Washington, Washington State, Portland State, Oregon State, and Oregon along with California State Polytechnic, Long Beach State and San Diego State.

This was the first National Collegiate Championship ever held at the University of Maryland. The spacious facilities of Cole Fieldhouse were praised by the attending coaches and competitors.

## INDIVIDUAL CHAMPIONS AND PLACE WINNERS

Class	Champion	Second	Third	Fourth
115-lb. ....	Simons (Lock Haven)	Wilson (Toledo)	Fredericks (Iowa State)	Tamura (Oregon State)
123-lb. ....	Auble (Cornell U.)	Hatta (Okla. State)	Hansen (Wyoming)	Macias (Oklahoma)
130-lb. ....	Able (Oklahoma)	Lauchle (Pittsburgh)	Kelly (Iowa)	Hutcherson (Indiana)
137-lb. ....	Anderson (Iowa State)	Austin (Syracuse)	Leta (Rutgers)	Semary (Kent State)
147-lb. ....	Hayes (Iowa State)	Frude (Wyoming)	Clark (Lock Haven)	Fatta (Purdue)
157-lb. ....	Kraft (Northwestern)	Turner (Lehigh)	Marshall (Purdue)	Pifer (Penn State)
167-lb. ....	Ballinger (Wyoming)	Clinton (Okla. State)	Fitzgerald (Michigan U.)	Koehn (Minnesota)
177-lb. ....	Conrad (Northern Ill.)	Campbell (Oklahoma)	Rushatz (Army)	Campbell (Okla. State)
191-lb. ....	Goodner (Oklahoma)	Stanbro (Ithaca)	Eckley (Waynesburg)	Trapp (Iowa)
Hvywt .....	Lewis (Oklahoma)	Thorsen (Iowa)	Oberly (Penn State)	Weber (Northwestern)

## TEAM SCORING

Oklahoma 59, Iowa State 40, Wyoming 36, Iowa 32, Oklahoma State 29, Lock Haven 25, Penn State 23, Pittsburgh 21, Northwestern 20, No. Illinois 17, Cornell U. 17, Lehigh 16, Purdue 14, Syracuse 11, Ithaca 11, Rutgers 10, Toledo 10, Michigan U. 9, Michigan State 9, Indiana 9, Oregon State 8, Waynesburg 8, Army 7, Kent State 6, Minnesota 6, Portland State 6, Yale 5, West Chester 5, Oregon 5, Cornell Col. 5, Colorado St. Col. 4, Mankato State 4, Utah 4, Springfield 3, So. Illinois 3, Rochester Tech 3, Maryland 2, Kansas State 2, Iowa State Tchrs. 2, Brown 2, Ohio State 2, Ohio U. 2, South Dakota State 2, Washington State 2, Nebraska 1, Bowling Green 1, USCGA 1, Colorado Mines 1, Knox College 1.

## National Collegiate Tournament Results

## 115-Pound Class

FIRST ROUND—Dooley (Kansas State) d. Lamb (Indiana) 5-3; Tamura (Oregon State) d. Campana (Springfield) 2-0; Confer (Penn State) d. McNeil (Iowa St. Tchrs.) 4-0; Thamert (Mankato State) d. Moore (Ohio State) 3-0; Wilson (Toledo) d. McCann (Oklahoma State) 10-3; Simons (Lock Haven) pinned Pierce (Delaware) 8:44; Fredericks (Iowa State) d. Rittschol (Wisconsin) 11-4.

QUARTER-FINAL ROUND—Tamura d. Dooley 1-0; Simons d. Thamert 13-6; Wilson d. Confer 6-3; Fredericks d. Hogan (Rutgers) 8-1.

SEMI-FINAL ROUND—Wilson d. Tamura 5-2; Simons d. Fredericks 5-3.

FINAL ROUND—Simons d. Wilson 2-2-ot-3-3-unanimous decision; Consolation—Fredericks d. Tamura 3-0.

## 123-Pound Class

PRELIMINARY ROUND—Bledsoe (So. Illinois) d. Gates (Iowa) 7-5; Webster (Iowa State) d. Sachsels (Notre Dame) 4-0; Macias (Oklahoma) d. Frame (Mankato State) 8-5; Hobbs (Michigan State) d. Cassel (Frank. & Marsh.) 8-3; Hansen (Wyoming) d. Mayberry (Washington U.) 8-2.

FIRST ROUND—Hatta (Oklahoma State) d. Leich (Rutgers) 16-7; Macias d. Scordo (Penn State) 5-2; Auble (Cornell U.) d. Webster 6-1; Camione (Ohio State) d. Hobbs 9-5; Martin (Pittsburgh) d. Perez (Oregon State) 6-1; Hansen d. Van Auken (Maryland) 7-2; Tisone (Colorado Mines) d. Lane (Iowa State Teachers) 7-6; Bledsoe d. Bingham (Utah) 12-7.

QUARTER-FINAL ROUND—Bledsoe d. Tisone 7-2; Auble d. Macias 5-2; Camione d. Martin 11-9; Hatta d. Hansen 13-4.

SEMI-FINAL ROUND—Auble d. Bledsoe 12-4; Hatta d. Camione 11-11-ot-9-5.

FINAL ROUND—Auble d. Hatta 9-5. Consolation—Hansen d. Macias 4-4-ot-0-0-split decision.



1960 NATIONAL INDIVIDUAL TILTISTS: Left to right, front row—Elliott Simons (Lock Haven), Dave Auble (Cornell U.), Stanley Abel (Oklahoma), Les Anderson (Iowa St.); back row—Larry Hayes (Iowa St.), Art Kraft (Northwestern), Dick Ballinger (Wyoming), Roy Conrad (No. Illinois), George Goodner (Oklahoma), Dale Lewis (Oklahoma).

### 130-Pound Class

PRELIMINARY ROUND—DiBella (USCGA) d. McCrillis (Iowa State) 7-4; DeLeon (Mankato State) d. Vallentine (Ithaca) 8-4; Lauchle (Pittsburgh) d. Kelly (Iowa) 6-4.

FIRST ROUND—Abel (Oklahoma) d. DeLeon 6-1; Lauchle d. Freeman (Iowa St. Tchrs.) 3-0; Bryant (Colorado St. Col.) d. Cliatt (Maryland) 5-3; Headington (Utah) d. Danks (Penn State) 6-5; West (Rochester Tech) d. Baillie (Lehigh) 6-2; Hoagland (Portland State) d. DiBella 8-2; Hutcherson (Indiana) d. Corn (Western State Col.) 6-2; Young (Michigan State) d. Kehrig (Lycoming) 5-1.

QUARTER-FINAL ROUND—West d. Hoagland 4-0; Abel d. Hutcherson 9-5; Lauchle d. Headington 8-2; Young pinned Bryant 8:37.

SEMI-FINAL ROUND—Abel d. West 9-4; Lauchle d. Young 4-0.

FINAL ROUND—Abel d. Lauchle 5-2. Consolation—Kelly forfeit from Hutcherson.

### 137-Pound Class

PRELIMINARY ROUND—Anderson (Iowa State) pinned Bamforth (V.M.I.) 6:22; Leta (Rutgers) d. Romig (Lycoming) 4-1; Kelvington (Pittsburgh) pinned Scott (Wyoming) 7:38; Brainerd (Iowa St. Tchrs.) pinned Youngbauer (Mankato State) 7:08; Van Ness (Maryland) d. Lucy (Iowa) 8-2; Taylor (Cornell Col.) d. Wilson (Oklahoma State) 10-10-ot-4-0; Zboray (Indiana) d. Whitfield (Oklahoma) 5-2.

FIRST ROUND—Taylor d. Huffmann (Rochester Tech) 3-2; Leta d. Coffee (Minnesota) 7-6; Kelvington pinned Reed (Virginia) 7:24; Anderson d. Rowe (Knox College) 10-3; Austin (Syracuse) d. Brainerd 7-2; Semary (Kent State) d. Van Ness 5-3; Guccione (Penn State) d. Zboray 6-4; Word (Kansas State) d. Rimple (Bloomsburg) 7-1.

QUARTER-FINAL ROUND—Austin pinned Semary 2:29; Anderson d. Kelvington 5-2; Leta d. Taylor 4-3; Guccione d. Word 12-5.

SEMI-FINAL ROUND—Anderson d. Leta 3-1; Austin d. Guccione 4-4-ot-4-1.

FINAL ROUND—Anderson d. Austin 6-3. Consolation—Leta d. Semary 6-4.

**147-Pound Class**

PRELIMINARY ROUND—Zolikoff (Pittsburgh) d. Gregory (Oklahoma) 4-2; Fatta (Purdue) d. Peterson (Cornell Col.) 4-3; Rossberg (Iowa) d. Besnier (Maryland) 3-1; Frude (Wyoming) d. Hoppel (Bowling Green) 7-1; Clark (Lock Haven) pinned McSwain (North Carolina) 2:49; Minor (Penn State) d. Kane (V.M.I.) 6-0; Berry (Washington State) pinned Lindemann (Mankato State) 7:11; Ryan (Ohio U.) d. Estabrook (Harvard) 8-6; Grifa (Rutgers) d. Jordan (San Diego State) 5-2.

FIRST ROUND—Rossberg d. Berry 8-6; Frude d. Gunst (Lehigh) 11-8; Minor d. Gard (Kansas State) 5-0; Clark d. Wilson (Oklahoma State) 7-4; Hayes (Iowa State) pinned Ryan 7:19; Fatta d. DeLozier (Frank. & Marsh.) 3-2; Zwegyardt (Oregon State) d. Zolikoff 4-2; Grifa d. Gras (Fairleigh-Dickinson) 5-2.

QUARTER-FINAL ROUND—Frude d. Minor 7-2; Hayes pinned Rossberg 8:50; Clark d. Grifa 9-5; Fatta d. Zwegyardt 1-1-ot-5-2.

SEMI-FINAL ROUND—Hayes d. Fatta 3-0; Frude d. Clark 9-4.

FINAL ROUND—Hayes d. Frude 4-1. Consolation—Clark d. Fatta. 6-3.

**157-Pound Class**

PRELIMINARY ROUND—Ehler (Portland State) pinned Lightner (USCGA) 3:40; Pifer (Penn State) pinned Schlieff (Minnesota) 4:21; Marion (Cornell U.) pinned Jamrez (Ball State) 7:57; Terry (Oklahoma) d. Guzak (No. Illinois) 5-2; Davis (West Chester) d. Daniels (V.M.I.) 5-0; Hankin (Utah) d. Gridley (State U. of New York) 12-4; Kerin (Maryland) d. Dake (Bowling Green) 9-4; Turner (Lehigh) d. Flesner (So. Dakota State) 8-2; Mullins (Iowa) d. Peterson (Mankato State) 4-2; Kraft (Northwestern) d. Rinker (Rutgers) 9-3; Meloney (Iowa State) d. Rohm (Bloomburg) 4-0; Marshall (Purdue) d. Johnson (Oklahoma State) 2-0; Fivian (Oregon State) d. Zoyhowski (Rochester Tech) 4-0; Parker (Cornell Col.) d. Tavenner (Michigan State) 3-3-ot-3-1.

FIRST ROUND—Kraft d. Hankin 7-1; Turner pinned Parker 4:26; Ehler d. Davis 3-2; Marion pinned Harris (Grinnell) 5:07; Pifer d. Terry 8-5; Mullins d. Kerin 6-5; Fivian d. Meloney 3-1; Marshall d. Brown (Denison) 7-0.

QUARTER-FINAL ROUND—Ehler pinned Marion 7:10; Kraft d. Pifer 5-4; Turner d. Mullins 5-1; Marshall d. Fivian 1-1-ot-3-0.

SEMI-FINAL ROUND—Kraft d. Ehler 6-5; Turner d. Marshall 6-4.

FINAL ROUND—Kraft d. Turner 5-3. Consolation—Marshall d. Pifer 5-1.

**167-Pound Class**

PRELIMINARY ROUND—Wilson (Colorado St. Col.) d. Schaefer (Moravian) 4-1; Kreamer (Lock Haven) d. Haeefle (Rochester) 11-6; Koehen (Minnesota) d. Rischell (Maryland) 4-0; Ballinger (Wyoming) d. Slattery (Mankato State) 5-3; Barone (Penn State) d. Million (Ball State) 9-3; Clinton (Oklahoma State) default Russell (North Carolina) 3:45; Friedel (West Chester) pinned DeButts (Virginia) 8:21; Fitzgerald (Michigan U.) d. Bartlett (V.M.I.) 8-1; Miller (Yale) d. Neal (Carleton) 20-2.

FIRST ROUND—Clinton d. Angell (Lehigh) 10-8; Miller d. Sanders (V.P.I.) 5-3; Fitzgerald d. Sterner (South Dakota State) 8-5; Friedel pinned Ferguson (Cornell Col.) 3:15; Wilson d. Skuba (Rutgers) 5-0; Kreamer d. Walston (Iowa U.) 2-1; Ballinger d. Barone 8-2; Koehen d. Butler (Oklahoma) 7-2.

QUARTER-FINAL ROUND—Wilson d. Kreamer 5-2; Ballinger d. Koehen 4-2; Clinton d. Friedel 13-8; Fitzgerald d. Miller 11-1.

SEMI-FINAL ROUND—Clinton d. Fitzgerald 7-4; Ballinger d. Wilson 2-2-ot-2-0.

FINAL ROUND—Ballinger d. Clinton 6-4. Consolation—Fitzgerald d. Koehen 2-1.

**177-Pound Class**

PRELIMINARY ROUND—Vuocolo (Pittsburgh) d. Myer (So. Illinois) 7-6; B. Campbell (Oklahoma State) d. Smith (Iowa State) 8-5; Conrad (No. Illinois) pinned Sterner (South Dakota State) 1:49; Stevens (Cornell Col.) d. Matulonis (Maryland) 3-1; DiMuccio (Springfield) d. Roulson (Iowa) 11-1; Ihnat (Indiana) d. Begala (Kent State) 3-0; Brownlee (Wyoming) d. Will (Yale) 4-1.

FIRST ROUND—Brownlee d. Eckley (Waynesburg) 8-6; Rushatz (Army) d. Conners (V.M.I.) 12-0; Ihnat d. Yates (U. of the South) 7-1; Vuocolo pinned Narciso (Rutgers) 8:52; B. Campbell d. Koehnen (Minnesota) 6-3; D. Campbell (Oklahoma) pinned Stevens 5:34; Conrad d. Myer (Penn State) 9-0; DiMuccio d. Detrixhe (Lehigh) 4-3.

QUARTER-FINAL ROUND—Rushatz d. Brownlee 9-1; Conrad pinned B. Campbell 4:08; Ihnat d. Vuocolo 4-2; D. Campbell d. DiMuccio 6-1.

SEMI-FINAL ROUND—Conrad pinned Ihnat 2:24; D. Campbell d. Rushatz 15-3.

FINAL ROUND—Conrad d. D. Campbell 14-13. Consolation—Rushatz d. B. Campbell 5-4.



**191-Pound Class**

PRELIMINARY ROUND—Trapp (Iowa State) pinned Smith (Lawrence) 7:29; Moore (Lehigh) d. DeStefano (Springfield) 9-4.

FIRST ROUND—Stanbro (Ithaca) pinned Paniotowski (Maryland) 7:54; Sherrill (Yale) d. Kohlhafer (Baltimore) 7-6; Trapp d. Keckor (Long Beach State) 2-1; Giorgini (Brown) d. Moore 10-7; Olm (Michigan) d. Cory (Rutgers) 6-1; Goodner (Oklahoma) d. Trojan (Penn State) 5-0; Eckley (Waynesburg) d. Colling (Wyoming) 11-3; Williams (Oklahoma State) d. Hall (Pittsburgh) 10-5.

QUARTER-FINAL ROUND—Stanbro d. Sherrill 9-2; Goodner pinned Giorgini 8:41; Eckley pinned Williams 7:22; Trapp d. Olm 3-3-ot-1-1—split decision.

SEMI-FINAL ROUND—Goodner d. Eckley 11-5; Stanbro d. Trapp 6-2.

FINAL ROUND—Goodner d. Stanbro 4-3. Consolation—Eckley d. Trapp 10-1.

**Heavyweight Class**

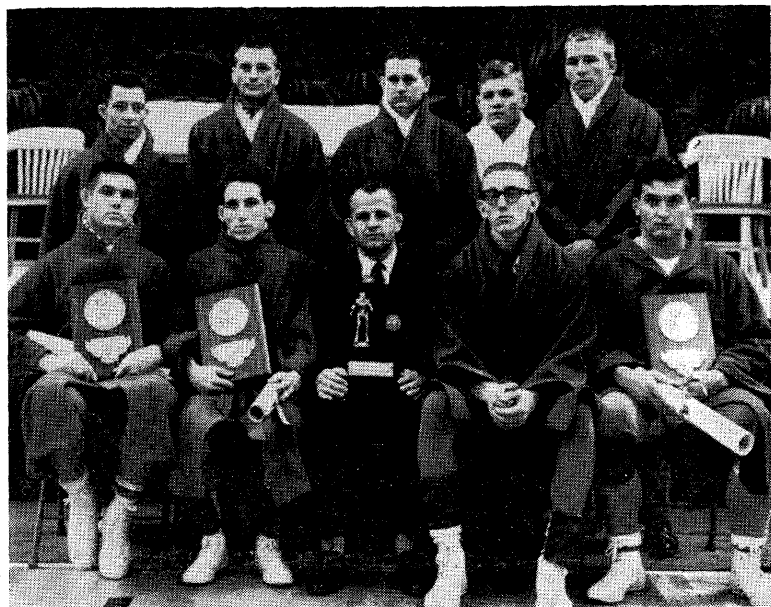
PRELIMINARY ROUND—Klaus (Rochester Tech) d. Lovell (Calif. State Poly.) 3-2; Baum (Michigan State) pinned Sierk (Rutgers) 1:45; Thorsen (Iowa) pinned Dawson (Wyoming) 4:53; Stensland (Oregon) pinned Blake (Mankato State) 6:39.

FIRST ROUND—Wright (Cornell Col.) d. Klaus 5-0; Stensland d. Wood (Brown) 2-0; Baum pinned Kurtenbach (South Dakota State) 5:43; Thorsen d. Oberly (Penn State) 7-2; Weber (Northwestern) pinned Kuhns (Army) 2:39; Lewis (Oklahoma) pinned Hacker (Maryland) 5:59; Schwitters (Iowa State) d. Farmer (State U. of New York) 3-0; Raschke (Nebraska) d. Asack (Columbia) 9-5.

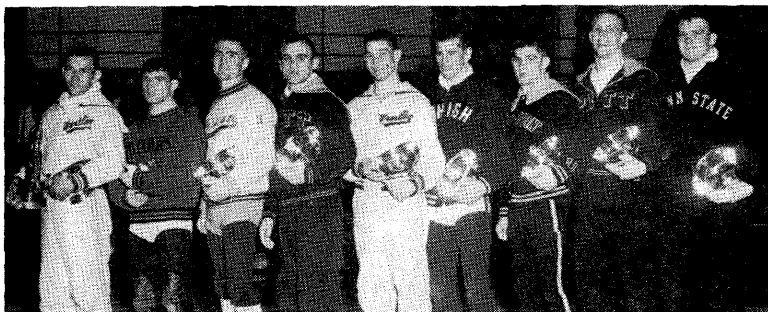
QUARTER-FINAL ROUND—Thorsen d. Schwitters 8-2; Lewis d. Stensland 4-1; Weber d. Wright 0-0-ot-0-0—unanimous decision; Baum d. Raschke 6-2.

SEMI-FINAL ROUND—Thorsen d. Baum 3-1; Lewis d. Weber 1-1-ot-3-1.

FINAL ROUND—Lewis d. Thorsen 3-1. Consolation—Oberly d. Weber 3-2.



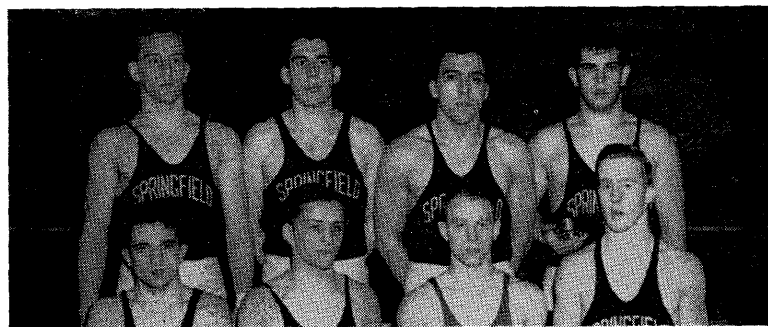
UNIVERSITY OF OKLAHOMA—REGAINS NATIONAL TEAM CHAMPIONSHIP: Left to right, front row—Goodner, Abel (capt.), Coach Evans, Campbell, Evans; back row—Macias, Gregory, Whitfield, Terry, Butler.



*EIWA INDIVIDUAL CHAMPIONS: Left to right—Auble (Cornell), Leta (Rutgers), Austin (Syracuse), Zolikoff (Pittsburgh), Marion (Cornell), Turner (Lehigh), Rushatz (Army), Hall (Pittsburgh), Oberly (Penn State).*



*WILKES COLLEGE—MIDDLE ATLANTIC CHAMPIONS WIN FOURTH IN A ROW: Left to right, front row—Yeager, Stauffer, Morgan, Senick; back row—Coach Reese, Tohiba, Rittenhouse, Antinnes, Herman, Morris (asst. coach).*



*INDIVIDUAL RULERS IN NEW ENGLAND ASSOCIATION: Left to right, front row—Campana (Springfield), Dibella (Coast Guard), Williams (Wesleyan), Heinze (Springfield); back row—Recher, Moyer, DiMuccio, DeStefano (all of Springfield).*

# COLLEGIATE REVIEWS

## Eastern Intercollegiate Wrestling Association

By **GEORGE L. SHIEBLER**, *Associate Commissioner, ECAC*

Heavyweight Johnston Oberly pinned Brown's William Wood at 3:38 of the first period to give Penn State a 66-66 deadlock with Pittsburgh in the final match of the 56th EIWA championships held in Princeton's Dillon Gymnasium. It was a dramatic climax to a sensational and thrilling tourney. Lehigh, the 1959 titleholder finished third with 43 points.

Both Pitt and Penn State had been undefeated in dual competition, battling to a 14-14 draw in their regular season meeting.

The championship tie was the first since 1941 when Princeton and Yale were deadlocked and the third tie in the history of the event. Penn State and Lehigh are now tied in total wins, thirteen and one-half each. Pitt, a relative newcomer to the EIWA, won three consecutive titles in 1954-55-56.

Penn State's Oberly, needing a pin to gain the tie, downed Wood with a figure-four head-scissors to lift the Nittany Lions from a 66-62 deficit.

Pitt and Cornell each had two EIWA champions—John Zolikoff (147) and Thomas Hall (191) for the Panthers and David Auble (123) and Allan Marion (157) for the Big Red. Penn State, Lehigh, Syracuse, Rutgers and Army each had an individual champion.

**TEAM SCORING**—Penn State and Pittsburgh 66 each, Lehigh 43, Cornell 36, Syracuse 31, Rutgers 24, Yale 20, Army 17, Franklin & Marshall 16, Brown 11, Columbia 7, Pennsylvania 7, Harvard 5, Princeton 4, Temple 3 and Navy 1.

**123-LB—Auble (Cor)** champion, Martin (Pi) 2nd, Meyer (S) 3rd, Cassel (F) 4th; **130-LB—Leta (R)**, Lauchle (Pi), Baillie (L), Danks (PS); **137-LB—Austin (S)**, Kelvington (Pi), Guccione (PS), Alexander (L); **147-LB—Zolikoff (Pi)**, Minor (PS), Hawthorne (R), Glenn (A); **157-LB—Marion (Cor)**, Angell (L), Pifer (PS), Pollak (S); **167-LB—Turner (L)**, Seckler (PS) Donzanti (Pe), Taylor (F); **177-LB—Rushatz (A)**, Will (Y), Oberlander (Cor), Thomas (F); **191-LB—Hall (Pi)**, Myer (PS), Sherrill (Y), Ornstein (S); **HVYWT—Oberly (PS)**, Wood (B), Guzik (Pi), Asack (Col).

## New England I.W.A.

By **DICK KIPPERMAN**, *Sports Information Director, Springfield College*

Springfield's varsity wrestlers held true to form in the 14th New England Championships held in Williams College's Lasell Gym, when they claimed their 10th consecutive crown, supplied six of the eight individual champs and the wrestler gaining the fastest pin.

Among some 150 competitors from 10 colleges and universities throughout New England, two champs successfully defended their titles, each for the third successive year and both from Springfield—Bobby Campana (123) and Ralph DiMuccio (177). Two other Maroons, Fred Recher (157) and Mario DeStefano (heavyweight), NE champs last year as freshmen, won their first varsity titles.

Coast Guard's Joe DiBella was awarded the Coaches' Trophy as outstanding wrestler. Springfield's DeStefano gained a 1:05 pin over Amherst's Ken Bevis to win the Gorriaran Trophy, awarded each year to the wrestler gaining the fastest pin.

**TEAM SCORING**—Springfield 96, Coast Guard 44, Williams and Amherst 31 each, MIT 13, Wesleyan 13, Massachusetts 10, Dartmouth 4, WPI—9, Connecticut—28.

**123-LB—Campana (S)** champion, Torbert (D) 2nd, Randall (A) 3rd, Leigh (CG) 4th; **130-LB—DiBella (CG)**, Smith (Wi), Calabrese (S), Bulfer (MIT); **137-LB—Williams (WE)**, Blood (A), Everling (S), Zins (CG); **147-LB—Heinze (S)**, Lightner (CG), Sullivan (MIT), Chase (Wi); **157-LB—Recher (SC)**, Wallace (M), Rees (WPI), Johnson (We); **167-LB—Moyer (S)**, Peel (CG), Oehrle (Wi), Bixler (A); **177-LB—DiMuccio (S)**, Wood (A), Meinke (We), Noland (Wi); **HVYWT—DeStefano (S)**, Fox (Wi), Constantino (C), Riley (M).

## Middle Atlantic States Collegiate Athletic Conference

By **ARTHUR J. HOOVER**, *Athletic Publicity Director, Wilkes College*

Wilkes, after completing its second successive undefeated season, copped the Middle Atlantic championship for the fourth consecutive year. Wilkes was the only entry to have two individual champions. Both Dick Stauffer, and Marv Antinnes, 1959's 123 and 167-pound champions respectively, moved up one weight class and clinched the 130 and 177-pound titles.

Host college Lebanon Valley gained one individual championship through the efforts of its 325-pound heavyweight, Ken Longenecker.

Harry Romig of Lycoming repeated as 137-pound champ and was named the outstanding wrestler for the second consecutive year.

**TEAM SCORING**—Wilkes 60, Bucknell 42, Moravian 38, West Chester State 37, Lycoming 33, Hofstra 27, Temple 23, Lafayette 19, Lebanon Valley 18, Ursinus 14, Delaware 12, Drexel 8, Dickinson 7, Muhlenberg 7, Gettysburg 6, Penn Military 6, Swarthmore 4, Elizabethtown 3, Albright 1, Juniata 0.

123-LB—Hannan (H) champion, Yeager (W) 2nd, Monastero (Dr) 3rd, London (La) 4th; 130-LB—Stauffer (W), Kehrig (Ly), Rinker (Mo), Ayre (B); 137-LB—Romig (Ly), Morgan (W), Fritts (B), Warner (Mu); 147-LB—Dean (U), Turner (Mo), Brust (B), Sackman (Di); 157-LB—Davis (WC), Muller (H), Osman (T), Bedies (Mo); 167-LB—Schaeffer (Mo), Brislin (La), Freidel (WC), Murdock (B); 177-LB—Antinnes (W), Gibson (WC), Osmun (De), Martins (PMC); HVYWT—Longenecker (LV), Whight (B), Quedenfeld (T), Herman (W).

## Wilkes College Open Tournament

By **ARTHUR J. HOOVER**, *Athletic Publicity Director, Wilkes College*

The New York Athletic Club won the 28th Annual Wilkes College Open and dethroned Pittsburgh which placed second after a three year championship reign. Two of the three N. Y. A. C. wrestlers, Greg Ruth (157) and Doug Blubaugh (167) captured championships, while the third member of the team, Hiroki Aoki, placed second in the 115-pound class.

Total entries in the tourney were 437 with the following representation: colleges and universities, 61; YMCA's, 6; organizations, 3; 16 states and Canada.

Doug Blubaugh of the N. Y. A. C. was named the outstanding wrestler for the second consecutive year. Blubaugh also won the high point trophy.

**TEAM SCORING**—New York AC 44, Pittsburgh 39, Rochester Tech 35, Wilkes 30, Yale 30, Virginia Tech 25, Winona 22, Lock Haven 20, Iowa 19, Rutgers 18, Bloomsburg St. 16, N. Y. U. 15, Lehigh 14, Army 14, Hofstra 13, Lycoming 13, Waynesburg 13, Gettysburg 12, Oswego 12, Lock Haven YMCA 11, Pennsylvania 11, Harvard 10, Springfield 10, Bucknell 9, Cornell 9, Michigan 9, West Virginia 7, Stevens 7, Ohio State 6, Maryland 5, Ft. Belvoir 4, Edinboro St. 4, Shippensburg St. 4, Clarkson 3, Princeton 3, Brown 3, Baltimore YMCA 2, Franklin and Marshall 2, Ithaca 2, Long Island Aggies 2, Toronto 2, Virginia 2, Wilmington YMCA 2, West Chester St. 2, Cortland 1, C. W. Post 1, Indiana St. 1, Syracuse 1, William and Mary 1, R.P.I. 1, Buffalo 1, Columbia 0, Hiram 0, Harrisburg YMCA 0, Penn Military 0, Shaker A. C. 0, St. Vincent 0, Coast Guard 0, Massachusetts 0.

115-LB—Simons (LH) champion, Aoki (NYA) 2nd, Grandstaff (VT) 3rd, Delozier (W) 4th; 123-LB—Martin (Pi), Aungst (LHY), Hill (LHY), Huff (IO); 130-LB—Glover (VT), Huff (Io), Lauchie (Pi), Kehrig (Ly); 137-LB—Bevilaqua (NYU), Alexander (unatt), Leta (Ru), Black (Pe); 147-LB—Huffman (RIT), Zolikoff (Pi), Grifa (Ru), Fortmyer (Ho); 157-LB—Ruth (NYA), Pendleton (unatt), Toluba (Wi), Sirota (Sy); 167-LB—Blubaugh (NYA), Zoyhowski (RIT), Millar (Y), Rymer (St); 177-LB—Rushatz (A), Antinnes (Wi), Rohm (Bl), Eckley (Wa); 191-LB—Sherrill (Y), Pacilio (Ge), DiMuccio (Sp), Graham (Bu); HVYWT—Wedemeyer (W), Farmer (OS), Olm (Mi), Garson (Bl).

## Pennsylvania State Colleges Tournament

By **S. G. JACOBS**, *Lock Haven State College*

Bloomsburg State for the second straight year won the Annual State Colleges Tournament, capturing five individual titles. Ralph Clark, Lock Haven, won his fourth straight championship, equaling the feat established by Steve DeAugustino, also a Lock Haven graduate.

**TEAM SCORING**—Bloomsburg 99, Lock Haven 82, Shippensburg 45, Millersville 41, Edinboro 24, East Stroudsburg 22, Clarion 6, Indiana 0, Shippery Rock 0.

**115-LB**—Simons (LH) champion, Hughes (B) 2nd, Thomas (E) 3rd, Boyd (S) 4th; **123-LB**—Gorant (B), Gleason (ES), Walker (LH), Caslow (C); **130-LB**—Sullivan (B), Steele (S), Lynch (LH), Swanson (E); **137-LB**—Gallucci (LH), Kalokerinos (S), Rimple (B), Rylee (M); **147-LB**—Rider (B), Meyerson (M), Burtnett (LH), Claycomb (S); **157-LB**—Clark (LH), Farley (M), Kobak (S), Bloxdorf (E); **167-LB**—Dixon (B), Zarbatany (ES), Sinibaldi (LH), Craver (M); **177-LB**—Rohm (B), Stidfole (S), Wagner (M), Mottorn (C); **191-LB**—Manning (E), Elinsky (B), Price (M), Lawhead (S); **HVYWT**—Kreamer (LH), Garson (B), Carnahan (M), Wilgard (ES).

## Southeastern Intercollegiate Championships

By JOHN A. DAVIS, *Tournament Director, Maryville College*

Auburn won the Southeastern title for the 14th consecutive time with a whirlwind finish as two Tiger wrestlers defeated 1959 first place winners by falls in the finals. The Tigers' Garner Hastings was picked as the outstanding wrestler, winning all of his matches by falls.

**TEAM SCORING**—Auburn 85, Chattanooga 64, Maryville 39, Emory 37, Sewanee 34, Birmingham-Southern 16.

**115-LB**—Baxter (M) champion, Holder (C) 2nd; **123-LB**—Wilson (E), Haynes (S), N. Nagel (C), Mease (M); **130-LB**—McCrary (A), Lacy (E), C. Nagel (C), Kite (B); **137-LB**—F. Hastings (A), Sears (E), McDonald (C), Bronson (B); **147-LB**—Thompson (A), Johnson (M), George (B), Smith (S); **157-LB**—Bratchler (C), Wunderlich (S), Wakelyn (E), Boyd (A); **167-LB**—Cox (C), Patrick (A), White (M), Mullen (E); **177-LB**—Yates (S), Branum (A), McFerren (M), Thornberry (C); **191-LB**—G. Hastings (A), Parker (C), Boyer (B), Franklin (M); **HVYWT**—Gross (A), Hubbert (C), Fairchild (M), Reagan (S).

## Southern Conference Tournament

By CHARLIE PARKER, *Coach, Davidson College*

Virginia Tech, led by Brandon Glover and Joe Heller, captured the Southern Conference Tournament held at Davidson College. Glover, 130-pound champion for the fourth straight year, was voted the outstanding wrestler.

**TEAM SCORING**—Virginia Tech 74, VMI 61, West Virginia 53, Citadel 28, Davidson 12.

**123-LB**—Bowman (VT), champion, Staton (W) 2nd, Reilly (C) 3rd, Mangino (VMI); **130-LB**—Glover (VT), Jennings (C), Murrill (VMI), G. Thompson (W); **137-LB**—Heller (VT), Bamforth (VMI), Petres (W), Rudick (C); **147-LB**—Kane (VMI), Lester (W), Piercy (VT), Koller (C); **157-LB**—Daniels (VMI), Johnston (W), McClintock (VT), LeDoyen (D); **167-LB**—Hoblitzell (W), Bartlett (VMI), C. Thompson (D), Fogg (VT); **177-LB**—Sanders (VT), Cunniff (C), Alexander (D), Merklinger (VMI); **HVYWT**—Bazzolli (W), Vishneski (VT), Connors (VMI), Reiny (C).

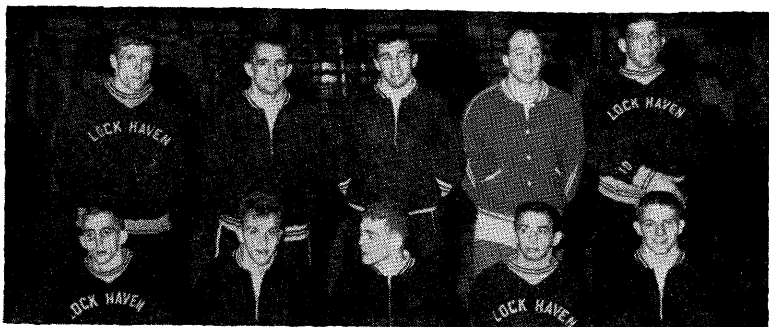
## Atlantic Coast Conference

By FRANK W. FINGER, *University of Virginia*

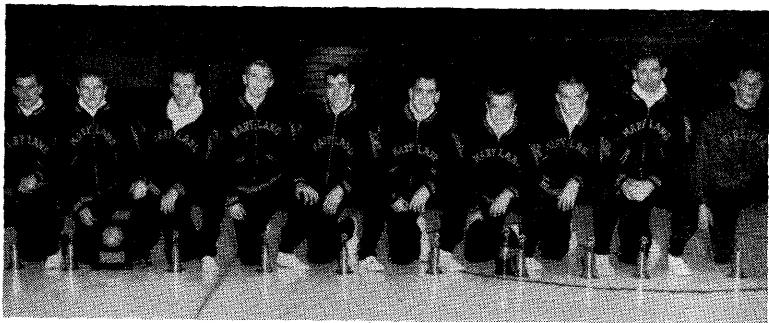
The University of Maryland again made the Atlantic Coast Conference Wrestling Tournament a runaway, barely missing a clean sweep of the individual titles. The sole non-Terrapin winner was Landon Hilliard of the runner-up Virginia team, who outpointed the defending heavyweight champion, Karl Schettler, in an overtime match. Dick Van Auken and Dick Besnier successfully defended their crowns. Gene Kerin was voted outstanding wrestler of the tourney.

**TEAM SCORING**—Maryland 104, Virginia 51, North Carolina 41, Duke 37, North Carolina State 19, Wake Forest 0.

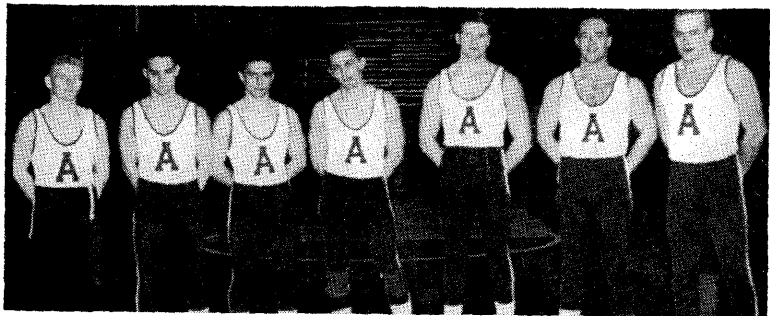
**115-LB**—Baker (Md) champion, Paul (D) 2nd, Matthews (NCS) 3rd, London (NC) 4th; **123-LB**—Van Auken (Md), Ryon (Va); **130-LB**—Cliatt (Md), Reed (Va), Gilchrist (NC), McChesney (D); **137-LB**—Guttermuth (Md), La Bone (D), Reynolds (NCS), Marks (NC); **147-LB**—Varre (Md), McSwain (MC), Shepard (Va); **157-LB**—Besnier (Md), Shuford (NC), Rowan (Va); **167-LB**—Kerin (Md), Maltese (MCS), Russell (MC), Wright (Va); **177-LB**—Rischell (Md), Harris (Va), Broyhill (NCS), Sproyes (NC); **191-LB**—Paniatowski (Md), Bengel (D), Standing (Va), Shipp (NC); **HVYWT**—Hilliard (Va), Schettler (D), Ruttenburg (NC), Sikora (Md).



*PENNSYLVANIA TEACHERS INDIVIDUAL MAT LEADERS: Left to right, front row—Simons (Lock Haven), Gorant (Bloomsburg), Sullivan (Bloomsburg), Galucci (Lock Haven), Rider (Bloomsburg); back row—Clark (Lock Haven), Dixon (Bloomsburg), Rohm (Bloomsburg), Manning (Edinboro), Kreamer (Lock Haven).*



*ATLANTIC COAST CONFERENCE CLASS WINNERS: Left to right—Baker, Van Auken, Cleatt, Guttermuth, Varre, Besnier, Kerin, Ritschell, Paniatowski (all of Maryland), Hilihard (Virginia).*



*MASON-DIXON MONARCH—AMERICAN UNIVERSITY: Left to right—Makarov, Hockenbury, Sibilia, Maier, Reid, Dobozy, McLean; absent—Evans and Maghan.*

## Mason-Dixon Tournament

The 18th annual Mason-Dixon tournament was held at Gallaudet College in Washington, D. C. and was won, for the first time, by a strong American University team which captured five individual titles.

Dick Kohlhafer, three-time champion, was the outstanding wrestler.

**TEAM SCORING**—American U. 74, Baltimore 35, Johns Hopkins 27, Hampden Sydney 26, Western Md. 25, Gallaudet 22, Loyola 18, Catholic U. 13, Towson State 4.

123-LB—**Possident (B)** champion, Makarov (A) 2nd, Orlando (T) 3rd, Iampieri 4th; 130-LB—**Price (WM)**, Hokenbury (A), Haney (H), Effenger (B); 137-LB—**Edgar (WM)**, Parr (L), Reinhart (C), Deschler (G); 147-LB—**SiBilia (A)**, Staab (B), Hairston (G), Thompson (C); 157-LB—**Maghan (A)**, Everet (HS), Hartman (C), Berlowitz (G); 167-LB—**Maier (A)**, Dates (H), Carey (L), Holman (HS); 177-LB—**Reid (A)**, Matney (HS), Rowe (H), Case (WM); 191-LB—**McLean (A)**, Bradley (HS), Currier (G), Garrett (L); **HVYWT**—**Kohlhafer (B)**, Kelley (H), Fairwood (G), DoBozy (A).

## CIAA Tournament

By **ROBERT N. GARDNER, Coach, Lincoln University**

Lincoln University retained its CIAA championship in the 25th Annual Tournament held at Lincoln University. Excellent matches prevailed throughout in spite of the fact that snow limited the number of institutions to three. The outstanding wrestler was John Haines of Lincoln, the defending 115-pound champion.

**TEAM SCORING**—Lincoln 97, Morgan State 72, Howard 63.

115-LB—**Haines (L)** champion, Burton (H) 2nd, Payne (M) 3rd; 123-LB—**Williams (L)**, Stewart (H); 130-LB—**Beane (L)**, Parker (H), Winston (M); 137-LB—**Gilbert (M)**, Bain (L), Caldwell (H); 147-LB—**Gray (H)**, Mitchell (M), Wilkerson (L); 157-LB—**Billups (L)**, Wooden (H) Reid (M); 167-LB—**Gardner (L)**, Walker (M), Booker (H); 177-LB—**Clough (L)**, Hall (M), Peoples (H); 191-LB—**Chase (M)**, Donaldson (L), Gross (H); **HVYWT**—**Barnes (L)**, Harrison (M), Johnson (H).

## Big Ten Championships

Michigan, paced by four individual champions, won the 1960 title. The Wolverines placed all eight entries in the quarter finals and then came through with seven of those contestants placing fourth or better to clinch the crown.

Awarded the coaches' trophy as the Outstanding Wrestler was Ohio State's Dave Camione (123). Non-scoring competition was held at 115-pounds (Fred Rittschof, Wisconsin), and 191-pounds because of the coming Olympics.

**TEAM SCORING**—Michigan 65, Iowa 50, Michigan State 37, Northwestern 28, Minnesota 27, Indiana 24, Purdue 17, Ohio State 16, Illinois 3, Wisconsin 0.

123-LB—**Camione (O)** champion, Hobbs (MS) 2nd, Hoyles (Mic) 3rd; 130-LB—**Wilbanks (Mic)**, Young (MS), Kelly (II); 137-LB—**Kellerman (Mic)**, Zboray (In), Coffee (Min); 147-LB—**Blaker (Mic)**, Wright (Min), Rossberg (Ia); 157-LB—**Marshall (P)**, Kraft (N), Jones (Ia); 167-LB—**Fitzgerald (Mic)**, Mullins (Ia), Tavenner (MS); 177-LB—**Trapp (Ia)**, Ihnat (In), Koehnen (Min); 191-LB—**Curtis (Mic)**, Moriarty (P), Roulson (Ia); **HVYWT**—**Weber (N)**, Baum (MS), Thorsen (Ia).

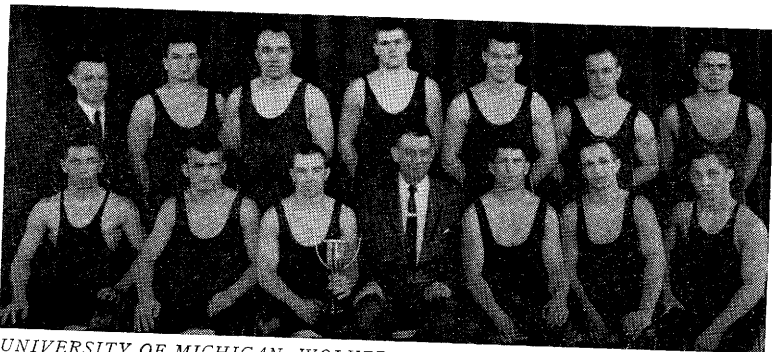
## Mid-American Conference Championships

By **JOE BEGALA, Kent State University**

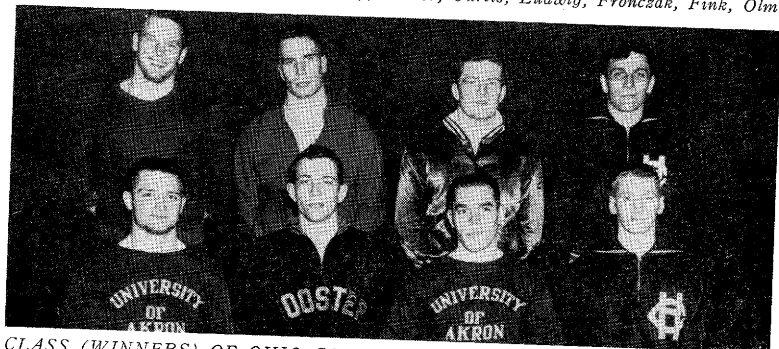
The 9th annual Mid-American Conference Championships held at Kent State University were not decided until the last bout. Kent State had a chance to win or tie for top honors but Western Michigan's Shaw turned in a "spoiler's role", which gave Bowling Green its second conference championship.

**TEAM SCORING**—Bowling Green 49, Kent State 47, Toledo 47, Miami 39, Ohio University 30, Western Michigan 25, Marshall 12.

123-LB—**Fleming (Mi)** champion, Stauber (T) 2nd, Brodbeck (B) 3rd, Mattern (Ma) 4th; 130-LB—**Wilson (T)**, Nader (K), Scott (Mi), Chadwick (O); 137-LB—**Semary (K)**, Sonner (O), Cyrus (Ma), Oswald (T); 147-LB—**Hoppel (B)**, Ryan (O), Kern (T), Bright (Mi); 157-LB—**Dake (B)**, Forrester (W), Dress (K), Evans (O); 167-LB—**Kaiser (Mi)**, Ruper (B), Spaulding (T), Gottdeiner (O); 177-LB—**Begala (K)**, Stoddard (T), Dianiska (B), Keelan (W); **HVYWT**—**Shaw (W)**, Youngblood (K), Gallat (Mi), Wilson (Ma).



UNIVERSITY OF MICHIGAN-WOLVERINES CONQUER BIG TEN: Left to right, front row—Root, Wilbanks, Hoyles (capt.), Coach Keen, Fitzgerald, Hildebrandt, Kellerman; back row—Cole (asst. coach), Blaker, Curtis, Ludwig, Fronczak, Fink, Olm.



CLASS (WINNERS) OF OHIO CONFERENCE: Left to right, front row—Wormald (Akron), Ruffner (Wooster), Lautenschlager (Akron), Havener (Hiram); back row—Wolf (Wittenberg), Dold (Denison), Menges (Ohio Wesleyan), Hlinka (Hiram).



OHIO CONFERENCE LEADER—BOWLING GREEN: Left to right—Coach Young, Kebl, Oianiska, Ruper, Dake, Hoppel, Voggenthaler, Letzner, Googins, Stagg, Brodbeck.



## Ohio Conference

By **TED GATHANY**, *Director, Ohio Conference Sports Bureau*

Hiram College won its second straight Ohio Conference championship in the biggest and most successful league meet ever held. Thirteen colleges were represented in the Eighth Annual Championships with Hiram and Akron each winning two individual titles, Wooster, Ohio Wesleyan, Denison and Wittenberg one each. Don Haverer of Hiram, Larry Wormald of Akron and George Menges of Ohio Wesleyan were repeat gold medal winners.

**TEAM SCORING**—Hiram 64, Akron 54, Denison 38, Oberlin 27, Ohio Wesleyan 22, Capital 20, Wooster 19, Kenyon 17, Muskingum 13, Wittenberg 12, Heidelberg 3, Mount Union 1, Otterbein 1.

**123-LB**—Haverer (Hi) champion, Eisenmann (A) 2nd, Thomas (Ob) 3rd, Kesselring (D) 4th; **130-LB**—Lautenschlager (A), Kamp (Hi), Smail (Mus), McDougald (Ob); **137-LB**—Ruffner (Wo), Blackwood (Hi), Sommers (D), Turner (A); **147-LB**—Wormald (A), Salter (Ob), Worbell (C), Gordon (Woe); **157-LB**—Hlinka (Hi), Schori (K), Reese (D), Carnahan (He); **167-LB**—Menges (OW), Brown (D), Miller (C), Woodworth (Hi); **177-LB**—Dold (D), Bogardus (Hi), Pier (A), White (OW); **HVYWT**—Wolff (Wi), Abbas (A), Rollit (K), Gaskill (C).

## Wheaton College Invitational Tournament

By **DAVE BELMAN**, *Wheaton College Sports Publicist*

The Salukis from Southern Illinois took the Wheaton Invitational crown for the fifth successive year, winning four individual championships.

The only two repeating champions were Northern Illinois' Roy Conrad (177) and Southern Illinois' Dick Frankenberger (137).

Host Wheaton took one championship when co-captain Bob Oury (157) won in overtime.

**TEAM SCORING**—Southern Illinois 95, Illinois State Normal 54, Northern Illinois 52, Eastern Illinois 45, Central Michigan 40, Wheaton 26, Augustana 16, Notre Dame 11, Bradley 4, Wabash 4, Western Illinois 3.

**115-LB**—Holcolm (CM) champion, Sheridan (ISN) 2nd, Ramos (SI) 3rd, Hough (WI) 4th; **123-LB**—Kontos (NI), Sachscl (ND), Coniglio (SI), Bee (E); **130-LB**—Bledsoe (SI), Semetis (E), Lees (Wh), Shoukley (A); **137-LB**—Frankenberger (SI), Keller (ISN), Rollins (CM), Doherty (Wa); **147-LB**—Weaver (ISN), Langenberg (CM), Oury (Wh), Boyum (A); **157-LB**—Oury (Wh), Lewis (SI), Guzak (NI), Williams (A); **167-LB**—Spicer (ISN), Plapp (SI), Gardner (E), Weber (B); **177-LB**—Conrad (NI), Pontikes (SI), Vierk (E), Rick (ISN); **191-LB**—Houston (SI), Browning (E), La Fond (ISN), Long (CM); **HVYWT**—Antwine (SI), Seeman (NI), Fulk (E), DeVoe (CM).

## College Conference of Illinois

By **AL HANKE**, *Coach, Lake Forest College*

Lake Forest College won its first College Conference of Illinois wrestling championship since the start of wrestling at the school five years ago, winning three individual championships, four seconds, one third, and a fourth. Carroll College won two championships and tied for second. Augustana won three titles and finished even with Carroll.

**TEAM SCORING**—Lake Forest 71, Carroll 52, Augustana 52, Millikin 31, Elmhurst 23.

**123-LB**—Kitisaki (C) champion, Rokop (LF) 2nd, Tate (M) 3rd, Csomo (E) 4th; **130-LB**—Schockley (A), Keepper (LF), Yersin (C), Augsburg (M); **137-LB**—Reincke (E), Henderson (LF), Woitte (A), Schenk (M); **147-LB**—Boyum (A), Strand (C), Armstrong (M), Johnson (LF); **157-LB**—Bonham (LF), Achepohl (C), Williams (A), Farris (M); **167-LB**—Suter (A), Owens (LF), Krueger (C), Moore (M); **177-LB**—Thomas (LF), Vandewater (M), Holst (C), Beier (A); **191-LB**—Stofflet (C), Ihlefeld (A), Glabowicz (LF), Frandsen (E); **HVYWT**—Totlis (LF), Feehan (E), Palmies (M), Ziemann (C).

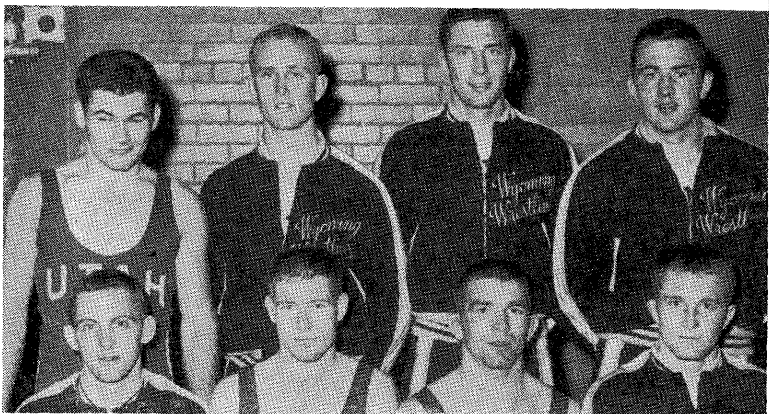
## Presidents' Athletic Conference

By **ROBERT L. MURPHY**, *Director, Public Information, Allegheny College*

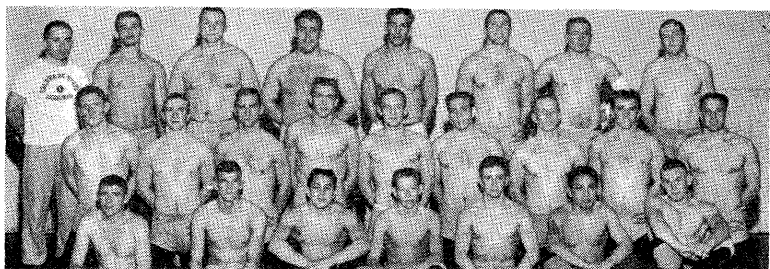
Allegheny College, trailing by 10 points at the start of the final round, saw all four of its finalists win individual championships to take the team title for the second consecutive year. A well balanced Thiel team finished second.



**CORNELL COLLEGE—19 TITLES IN TWO DECADES:** Left to right—Coach Bremmer, Steck, Wright, Stevens, Corvinn, Beisner, Parker, Cutsforth, Taylor, McClatchey. Also on squad—Petersen, Whitmer.



**INDIVIDUALS ON TOP IN SKYLINE CONFERENCE:** Left to right, front row—Hanson (Wyoming), Bingham (Utah), Headington (Utah), Frude (Wyoming); back row—Hankin (Utah), Ballinger (Wyoming), Brownlee (Wyoming), Colting (Wyoming).



**COLORADO ST. COLLEGE—WINS 24TH CONSECUTIVE RMC CROWN:** Left to right, front row—Hunt, Jordan, Sandoval, Croissant, Jamsay, Gibbs; middle row—Humphrey, McPee, Vuxinic, Hood, Bryant, Wills, Enockson, Anderson, Harden; back row—LaBlonde (asst. coach), Wilson, Trimmer, Sturbaum, Lordino, Patterson, Hayes, Harrison.

Dave Dunn, of Allegheny, 167-pound champion in 1959, took the 177-pound crown, and Pat McCormick, Washington and Jefferson, 123-pound king last year, won at 130.

**TEAM SCORING**—Allegheny 52, Thiel 49, Western Reserve 38, Case 34, Washington & Jefferson 34, Wayne 23, Bethany 6.

123-LB—Coulter (A) champion, Shelton (T) 2nd, McConnel (W&J) 3rd, Podowski (C) 4th; 130-LB—McCormick (W&J), Coco (T), Macko (C), Veraldi (A); 137-LB—McChesney (A), Corrigan (C), Olson (T), Dewey (C); 147-LB—Hasbrouck (C), Barry (W), Snee (W&J), Kampe (WR); 157-LB—Bernhard (A), Rhodes (T), Mika (W&J), Klauss (WR); 167-LB—Mason (W), Norris (C), Williamson (T), Gaiser (A); 177-LB—Dunn (A), Gordon (WR), Rumbaugh (T), Maynard (C); HVYWT—O'Hara (W), Reiley (W&J), Powers ((B), Brown (T).

## Iowa Collegiate Conference Championships

By WARREN G. BERG, *Sports Information Director, Luther College*

**TEAM SCORING**—Upper Iowa 58, Wartburg 58, Luther 49, Dubuque 39, Simpson 18, Parsons 15, Buena Vista 4.

123-LB—Sternberg (W) champion, Persons (L) 2nd, Moon (D) 3rd, Holliday (P) (4th); 130-LB—Liston (L), Staves (P), Limperis (D), Smith (W); 137-LB—Mueller (W), Youngblut (UI), Ingvalson (L), Thomas (P); 147-LB—Mangan (UI), Biggs (S), Smith (W), Olson (B); 157-LB—Hildebrandt (W), Fox (D), DeBerg (UI), Kjome (L); 167-LB—Frethem (L), Brown (D), Ray (S), Miller (UI); 177-LB—Evans (UI), Hassman (W), Weise (D), Norris (S); HVYWT—Dirks (UI), Pruisner (L), Snook (D), Scharnhorst (W).

## Iowa Teachers Invitational

By GEORGE WINE, *Iowa State Teachers College*

**TEAMS**—Cornell, Dubuque, Iowa, Iowa State, Iowa Teachers, Mankato State, Minnesota, Nebraska, Northwest Missouri, Upper Iowa, Winona State.

115-LB—Delosey (WS) champion, Fox (IT) 2nd, Steward (IS) 3rd, Grandon (IT) 4th; 123-LB—McNiel (IT), Barnhill (I), Webster (IS), D. Huff (I); 130-LB—Freeman (IT), Jensen (IT), T. Huff (I), Lane (IT); 137-LB—Jones (I), Sanford (IT), Coffee (Minn), Green (MS); 147-LB—Copple (Neb), Coburn (IS), Mead (unattached), Dotson (IT); 157-LB—Reifsteck (Minn), Wright (Minn), Weiland (I), Murry (IS); 167-LB—Peterson (MS), Willmorth (NM); 177-LB—Chezum (I), Smith (IT), Thompson (unattached), Straw (I); 191-LB—Koehner (Minn), Trapp (I), Christ (MS), Shook (D); HVYWT—Wright (C), Brand (N), Amos (MS).

## Indiana Little State Tournament

By DON TOURTELOT, *Sports Information Director, DePauw U.*

Indiana Central dethroned Wabash in a tight three-way battle in the second annual Little State tourney. Only five points separated the top three teams, with Indiana Central scoring 58 to Ball State's 55 and Wabash's 53.

Pat Haney (123) of Wabash was named the top individual wrestler, and both Willie Martin (147) of Indiana Central and Don Jamroz (157) of Ball State made successful title defenses. A third 1959 champion, Jim Trees of DePauw, vacated his title at 177 and picked up the 167-pound crown.

**TEAM SCORING**—Indiana Central 58, Ball State 55, Wabash 53, DePauw 43, Indiana State 14, Valparaiso 4, St. Joseph's 2.

123-LB—Haney (W) champion, Welliever (IC) 2nd, Giessler (BS) 3rd, McCoy (D) 4th; 130-LB—Kovach (BS), Doherty (W), Ashman (IC), Ross (D); 137-LB—Ramsey (IC), Witt (W), Allen (D), Mettler (SJ); 147-LB—Martin (IC), Ogelman (D), VanEtten (W), Moody (IS); 157-LB—Jamroz (BS), Ford (IS), Combs (W), Clifford (D); 167-LB—Trees (D), Hurrle (IC), Jay (W), Rodehorst (V); 177-LB—Reed (D), Million (BS), Erickson (W), Lyzott (IC); HVYWT—Thomas (BS), Jackson (IC), Beuthin (W), Rusk (IS).

## Four-I Championships

By CLAUDE SHARER, *Case Tech*

**TEAMS**—Ball State, Bowling Green, Buffalo, Clarkson, Colgate, Cortland, Edinboro State, Hiram, Ithaca, Kent State, Marquette, Miami, Notre Dame, Ohio, Rochester Tech, Toledo, Washington & Jefferson, Waynesburg, Western Michigan, Wheaton.

117-LB—Wilson (T) champion, Findlay (M) 2nd, Dodd (Wa) 3rd, Morris (H) 4th; 123-LB—Moore (Wa), Sangiore (I), Havner (H), Ciccarelli (Wh); 130-LB—Valentine (I), Walters (Wa), McCormick (W&J), Kovach (Ba); 137-LB—West (RT), Semary (KS), Valentic (Bu), Knapp (C); 147-LB—Huffman (RT), Hoppel (BG), Ryan (O), Dillingham (Co); 157-LB—Dake (BG), Oury (Wh), Forester (WM), Sheer (Co); 167-LB—Zoyhowski (RT), Million (Ba), Kaiser (Mi), Meredith (Col); 177-LB—Eckley (Wa), Begala (KS), Manning (E), Kane (ND); 191-LB—Stanbro (I), Shaw (WM), Brunette (ND), Noroian (RT); HVYWT—Eckley (Wa), Farmer (I), Hancock (Col), Klaus (RT).

## Midwest College Conference Championships

By RANDY HAASE, *Appleton Post-Crescent*

Cornell College breezed to its 18th championship in 19 Midwest conference meets, more than doubling the total of its nearest competitor—in fact, piling up more points than its two closest competitors combined. Four champions successfully defended their crowns while two others moved down a weight each to add new honors. Bob Smith, Lawrence, outstanding performer as heavyweight in 1959, moved down to 191 and racked up three more pins in 7:24. Fred Wright, Cornell heavyweight, pinned three opponents in 8:17 and ran his season string to 22 straight wins.

**TEAM SCORING**—Cornell 98, St. Olaf 43, Carleton 40, Grinnell 32, Lawrence 25, Knox 22, Monmouth 19, Coe 15, Beloit 5, Ripon 0.

123-LB—Severn (Ca) champion, Erickson (SO) 2nd, Kussendorf (M), Bachman (G) 4th; 130-LB—Taylor (Cor), Patton (G), Marti (B), Otterness (SO); 137-LB—Row (K), Cutsforth (Cor), Kauffman (L), Ahlstrom (SO); 147-LB—Peterson (Cor), Manley (G), Jermier (Coe), Haugen (SO); 157-LB—Burch (Ca), Harris (G), Beisner (Cor), Gudahl (SO); 167-LB—Ferguson (Cor), Borine (M), Garlie (SO), Sweazy (Ca); 177-LB—Stevens (Cor), Neal (Ca), Richards (K), Johnson (SO); 191-LB—Smith (L), Burton (Cor), Phillips (M), Mair (SO); HVYWT—Wright (Cor), J. Anderson (Coe), B. Anderson (SO), Glockner (L).

## Northern States College Conference

By R. G. MACIAS, *Coach, Mankato State College*

Mankato State College won its fifth straight Northern States College Conference title, but with lots of strong opposition.

Jack Thamert, Dave Frame, Ron Youngbauer and Jerry Slattery of Mankato St. and Jerry Wedemair of Winona St. successfully defended their conference titles.

**TEAM SCORING**—Mankato State 83, St. Cloud State 68, Winona State 61, Bemidji State 33, Moorhead State 25.

115-LB—Thamert (M) champion, Delozier (W) 2nd, Newell (SC) 3rd; 123-LB—Frame (M), Nelson (SC), Mitch (W); 130-LB—DeLeon (M), Amundson (SC), Willis (W); 137-LB—Lindeman (M), Morocco (W), Walters (SC); 147-LB—Youngbauer (M), Klick (SC), Musil (W); 157-LB—Wild (SC), Bailey (B), Schaible (M); 167-LB—Cronen (Mo), Pieper (W), Dilley (SC); 177-LB—Slattery (M), Halgerson (W), Ebert (SC); 191-LB—Palm (B), Wood (SC), Conn (Mo); HVYWT—Wedemair (W), Blake (M), Wigor (Mo).

## North Dakota State College Tournament

**TEAM SCORING**—Minot State 75, Valley City 61, North Dakota Aggies 58, Jamestown 40, Mayville 32, North Dakota 25, Dickinson 18.

115-LB—Reed (MS) champion, Holmes (Ag) 2nd, Olesberg (VC) 3rd, Alsop (J) 4th:

The 31st annual National Collegiate Wrestling Championships will be held March 23-25, 1961, at the Oregon State College, Corvallis, Ore.



*STANDING ROOM ONLY—Largest crowd ever to see collegiate wrestling match, 8,300 fans, strains seams of Oklahoma State's Gallagher Hall as Cowboys down national champion-to-be Oklahoma for second time in season by identical 14-11 scores.*

123-LB—Volk (MS), Wilson (J), Strommen (D), Bryon (Ma); 130-LB—Webb (MS), Holte (Ag), Oxton (D), Helm (J); 137-LB—Von Sickle (Ag), Volk (MS), Sharbano (J), Mueller (Ma); 147-LB—Nelson (MS), Johnson (Ag), Kuster (ND), Litsey (VC); 157-LB—Henke (Ag), Krueger (VC), Opstad (MS), Boeopflug (D); 167-LB—Krengstad (VC), Klostrich (J), Whitson (Ag), Ugelm (ND); 177-LB—Schimke (J), Kiedrowski (Ma), Svensenson (VC), Miller (D); 191-LB—Ramey (VC), Ellestad (MS), Anderson (ND), Lein (Ma); HVYWT—Larson (VC), Kappy (Ma), Steeves (ND), Delaney (MS).

## Big Eight (MVIAA) Championships

By OTIS WILE, Oklahoma State

The 1960 Big Eight Wrestling title still rests in Oklahoma but it moved from Stillwater to Norman in the tournament held at Lincoln, Nebr., March 4-5.

Oklahoma and Oklahoma State each won four titles with Iowa State and Kansas State gaining one apiece.

There were no pins in the finals and only one mild surprise. Lanky (6-5) Sooner Dave Campbell trounced defending 177-pound champ, Ron Meloney of Iowa State, 14-1.

**TEAM SCORING**—Oklahoma 83, Oklahoma State 73, Iowa State 58, Kansas State 28, Colorado 25, Nebraska 10.

**115-LB—Dooley (KS) champion**, Webster (IS) 2nd, McCann (OS) 3rd, Rethmeyer (N) 4th; **123-LB—Hatta (OS)**, Macias (O), D. Wilson (OS), Brown (IS), Huggins (KS); **137-LB—Anderson (IS)**, Word (KS), Gregory (O), Chesbro (OS); **147-LB—Hayes (IS)**, B. Wilson (OS), Whitfield (O), Gard (KS); **157-LB—Terry (O)**, Johnson (OS), Abraham (C), Lundy (KS); **167-LB—Clinton (OS)**, Strange (C), Johnson (O), Grover (IS); **177-LB—Campbell (O)**, Meloney (IS), Dowler (C), Murty (OS); **191-LB—Campbell (OS)**, Goodner (O), Bullard (C), Ferrebee (IS); **HVYWT—Lewis (O)**, Raschke (N), Schwitters (IS), Williams (OS).

## Rocky Mountain Conference

By JOHN W. HANCOCK, *Director of Athletics, Colorado State Col.*

Colorado State College won the Rocky Mountain Conference Wrestling Championship at Adams State College, Alamosa. This tournament was closely contested in every weight by the School of Mines and Western State. Colorado State College captured five individual championships.

**TEAM SCORING**—Colorado State Col. 77, Colorado Mines 58, Western State 56, Adams State 18.

**123-LB**—Jordan (CBC) champion, Tisone (CM) 2nd, Martinez (WS) 3rd, Daniels (AS) 4th; **130-LB**—Bryant (CSC), Corn (WS), Christiansen (CM), Ashton (AS); **137-LB**—Hasse (CM), Hollingshead (WS), Wills (CSC), Garvin (AS); **147-LB**—Sandelin (WS), Perkins (CM), Anderson (CSC), Wilhan (AS); **157-LB**—Bower (WS), Harrison (CSC), D. Meyers (CM), Tate (AS); **167-LB**—Wilson (CSC), Don Meyers (CM), Tolle (AS), Trujillo (WS); **177-LB**—Lordino (CSC), Paulsen (CM), Smith (AS), Fields (WS); **HVYWT**—Trimmer (CSC), Acre (WS), Helland (CM), Pallazo (AS).

## Mountain States Athletic Conference

By MARVIN G. HESS, *Coach, University of Utah*

Wyoming University, wrestling power of the Mountain States Athletic Conference (Skyline), once again defended its conference title by totaling 81 points to second place Utah's 59 in the meet held in Salt Lake City.

The Cowboys copped five individual places while the Utes had three, as no other school won an individual event. It was strictly a Cowboy and Indian affair.

Dick Ballinger of Wyoming successfully defended the 167-pound title for the third straight year. Frank Hankin of Utah won at 157 for the second year.

Jerry Frude of Wyoming, second in the national meet in 1959 and runner-up in the Skyline last year to Jerry Riter of Colorado State, dethroned Riter this time out.

**TEAM SCORING**—Wyoming 81, Utah 59, Colorado State U. 53, Denver 20, New Mexico 16, Brigham Young 15, Utah State 0.

**123-LB**—Hansen (Wyo) champion, Stevenson (Den) 2nd, Galvez (UT) 3rd, Von Wolf (NMU) 4th; **130-LB**—Bingham (UT), Busby (CSU), French (Wyo), Wilkins (BYU); **137-LB**—Headington (Ut), Scott (Wyo), O'Neil (NMU), Jack (BYU); **147-LB**—Frude (Wyo.), Riter (CSU), Young (Ut), Dewey (BYU); **157-LB**—Hankin (Ut), Gaskill (CSU), Donison (Den), Davis (Wyo); **167-LB**—Ballinger (Wyo), Holton (CSU), Kresge (BYU), Murray (Ut); **177-LB**—Brownlee (Wyo), Burge (CSU), Shepherd (Ut), Cohen (Den); **HVYWT**—Colling (Wyo), Kohls (CSU), Smylie (NMU), Fabel (Den).

## Pacific Coast Intercollegiate Tournament

Oregon State College defended its team title in the 11th annual PCI tournament at Cal Poly and annexed three individual championships.

**TEAM SCORING**—Oregon State 74, Washington State 58, Portland State 38, Oregon College of Education 30, Cal Poly 26, Oregon 23, Arizona 22, Long Beach State 22, Los Angeles State 19, San Diego State 17, Washington 11, San Jose 10, Lewis & Clark 9, California 8, Pacific 7, Stanford 6, Southern Oregon 4, UCLA 2, San Francisco State 1.

**115-LB**—Wood (A) champion, Kent (OCE) 2nd, Tamura (OSC) 3rd, Burnett (C) 4th; **123-LB**—Perez (OSC), Shrock (LC), McFarland (UO), Wahl (WSU); **130-LB**—Hoagland (PS), Mayberry (WU), Cook (WSU), Root (CP); **137-LB**—Morse (OCE), Hayward (LASC), Finley (OSC), Addleman (LBSC); **147-LB**—Berry (WSU), Zwegardt (OSC), Wilson (UO), Cutstorth (OCE); **157-LB**—Ehler (PS), Olsen (WSU), Jordan (SDS), Paz (CP); **167-LB**—Fivian (OSC), Campbell (WSU), Sullivan (SDS), Konsella (PS); **177-LB**—Conway (OSC), Slate (SJS), Conine (WSU), Easley (LASC); **191-LB**—Keelor (LBSC), Kauffman (OSC), Petersen (PU), Babbitt (WSU); **HVYWT**—Lovell (CP), Stensland (UO), Ismay (A), Cassidy (PS).

## California Junior College Championships

The San Bernardino Valley College team capped an outstanding season by winning the California Junior College Tournament for the third straight year. The SBVC Indians had previously captured Southern California honors and their conference title as well.

Placing second in the tournament was Cerritos, whose 123 pounder, Cisco Andrade, was voted the outstanding wrestler.

A total of 123 wrestlers from 13 junior colleges throughout the state participated in 154 bouts across the 2-day period.

The fastest fall of the tournament was accomplished by SBVC's heavyweight, Oliverson, in 23 seconds.

**TEAM SCORING**—San Bernardino Valley 84, Cerritos 69, Fresno CC 61, Modesto 42, El Camino 31, Los Angeles CC 28, Chaffey 22, Mt. San Antonio 18, Orange Coast 16, Citrus 5, Reedley 4, Palomar 2, Pierce 1, Santa Ana 0, Antelope Valley 0.

**115-LB**—Deffner champion, Davies 2nd, Matoba 3rd, Nakase 4th; **123-LB**—Andrade, Dantice, Bayne, Seagraves; **130-LB**—Combs, Seagle, Hoover, Cabral; **137-LB**—Moore, Buckalew, Burdette, Baade; **147-LB**—Booth, Hemphill, Ortega, Snider; **157-LB**—Pamp, Schrivens, Guy, Hebert; **167-LB**—Bell, Johansen, Vollrath, Durboraw; **177-LB**—Sallinger, Schmidt, Luiz, Markarian; **191-LB**—Elliot, Aquino, Zitterkoph, Beach; **HVYWT**—Oliverson, Reed, White, Conklin.

## Idaho Junior College Conference Championships

By **CARL BAIR**, *Ricks College*

The first ICAC Junior College conference tournament was held at Cedar City, Utah by host school, College of Southern Utah. CSU and Ricks College were the strong competitors with the CSU team edging out the Viking squad on advancement and fall points.

**TEAM SCORING**—Southern Utah 66, Ricks 64, Snow 54, Boise JC 17, Carbon 16, Dixie 15.

**123-LB**—Packer (R) champion, Church (SU) 2nd, Thomas (S) 3rd; **130-LB**—Smith (R), Mortenson (SU), D'Oraszio (B), Cenison (S); **137-LB**—Manning (SU), Dart (S), Runyan (R), Boyles (D); **147-LB**—Harmon (S), Barnum (R), Campbell (D), Walton (C); **157-LB**—Bond (C), Hunter (SU), Haroldson (R), Pack (S); **167-LB**—Michelson (R), Hill (S), Anderson (SU), Shelton (B); **177-LB**—McKnight (SU), Ellis (B), Rindlesbacker (D), Neil (S); **HVYWT**—Peterson (S), Beck (R), Rider (SU), Durtz (C).

## Eastern California Conference Tournament

**TEAM SCORING**—San Bernardino 89, Orange Coast 62, Chaffey 48, Mt. San Antonio 44, Santa Ana 16, Citrus 8.

**123-LB**—Dantice (OC) champion, Lewis (SA) 2nd, Payne (SB) 3rd; **130-LB**—Combs (SB), Murphy (OC), Hutchins (MSA), Rist (Ch); **137-LB**—Wager (OC), Burdette (SB), Brown (MSA), Furry (SA); **147-LB**—Hemphill (SB), Boice (OC), Tessier (MSA), Mangus (Ch); **157-LB**—Pamp (SB), Bowers (Ch), Snider (OC), Andrews (Ch); **167-LB**—Durboraw (MSA), Jones (Ch), Wolfe (OC), Hart (SB); **177-LB**—Luiz (MSA), Stephenson (SB), Perez (Ch), Miller (OC); **191-LB**—Beach (SB), Zetterkopf (Ch), Sonke (MSA), Henson (OC); **HVYWT**—Oliverson (SB), White (Ch), Vierra (Ci), Bittner (MSA).

## NAIA Wrestling Tournament

By **S. G. JACOBS**, *Lock Haven State College*

Bloomsburg State College won the 1960 NAIA Wrestling Tournament, capturing two individual titles. Ralph Clark, 147, and Elliott Simons, 115, both of Lock Haven, won their second straight NAIA titles. Simons was voted the outstanding wrestler also for the second straight year. The fastest pin was recorded by Dick Sprague of Baldwin-Wallace, in 32 seconds.

**TEAM SCORING**—Bloomsburg State 79, Southern Illinois 73, Lock Haven State 62, Wilkes 23, Lycoming 21, Winona State 18, Appalachian 16, Baldwin-Wallace 13, Central Michigan 10, Fort Hayes 10, Moorehead State 10, Findlay 7, Edinboro 6, Shippensburg 5, Oregon Col. 2, St. Cloud 3, Indiana Central 1, Lincoln 0, St. Johns 0, St. Thomas 0.

**115-LB**—Simons (LH) champion, Votapka (FH) 2nd, Yeager (Wil) 3rd, Hughes (B) 4th; **123-LB**—Bledsoe (SI), Gorant (B), Walker (LH), Wolfe (Ly); **130-LB**—Sullivan (B), Cook (A), Lynch (LH), Kehring (Ly); **137-LB**—Romig (Ly), Rollins (CM) Rimple (B), Morraco (Win); **147-LB**—Clark (LH), Crider (SI), Rider (B), Delapiapa (F); **157-LB**—Rohm (W), Lewis (SI), Cox (A), Sinibaldi (LH); **167-LB**—Kreamer (LH), Cronen (M), Plapp (SI), Dixon (B); **177-LB**—Antinnes (Wil), Houston (SI), Elinisky (B), Manning (E); **191-LB**—Moore (SI), Poust (B), Herman (Wil), Lewis (BW); **HVYWT**—Antwine (SI), Wedemier (Win), Sprague (BW), Garson (B).

# 1960 Dual Meet Records

School	Coach	Record	School	Coach	Record
Adams State	Hoy Frakes	5-8-0	Elizabethtown	Richard Hershey	4-6-0
Air Force Academy	Karl Kitt	4-6-0	Elmhurst	O. M. Langhorst	0-11-0
Akron	Andy Maluke	7-1-0	Enory	Edward Cresap	4-6-0
Alfred	Alex Yunevich	4-3-0	Fairleigh-Dickinson	Robert Metz	3-6-0
Allegheny	John Chuekran	6-3-1	Findlay	George Hill	8-3-0
American U.	Frank Morgan	8-0-0	Fort Hays State	Walter Kroil	2-6-0
Amherst	Dwight Scandrett	4-3-0	Franklin & Marshall	Roy Phillips	7-4-0
Appalachian State	Joe Edminsten	10-1-0	Gettysburg	John Ridinger	2-9-0
Arizona	Fred Roby	3-2-0	Grinnell	Robert Peterson	2-5-0
Army	Leroy Alitz	6-4-0	Gustavus Adolphus	Don Roberts	3-7-0
Auburn	Arnold Umbach	4-2-0	Harvard	Robert Pickett	5-6-0
Augsburg	Eddor Nelson	8-4-0	Haverford	Gerald Harter	1-5-1
Baldwin-Wallace	John Summa	6-3-1	Hiram	Mike Koval	10-0-0
Ball State	George Mihal	0-7-1	Hobart	Ray DeMuth	0-6-1
Baltimore	William Owings	5-4-1	Hofstra	Peter Damona	3-6-1
Beloit	Pete Samuels	0-7-0	Howard U.	Sydney Hall	3-4-0
Bemidji State	Chester Anderson	7-5-1	Fumboldt State	Gordon Schroeder	3-3-0
Birmingham Southern	J. R. Mason	1-6-0	Illinois Normal	Eugene Hill	4-4-0
Black Hills	Tony Schaefer	6-3-3	Illinois Tech	Anthony Barbaro	6-2-1
Bloomburg State	Russell Houk	10-0-0	Illinois	Buel Patterson	3-11-0
Bowling Green (O.)	James Young	11-0-0	Indiana Central	Jay Windell	5-2-0
Bradley	Tom Coker	1-4-0	Indiana State (Pa.)	Lewis Shaffer	4-7-0
Brigham Young	Reed Weight	3-6-0	Indiana	Charley McDaniel	4-5-0
Brooklyn Poly	Harry Benvenuto	5-6-0	Iowa State	Harold Nichols	12-3-0
Brown	Ralph Arderton	2-6-1	Iowa Teachers	William Koll	6-3-2
Bucknell	Bill Wrabley	4-3-0	Iowa	David McCuskey	4-4-1
Buffalo	Ronald LaRoque	9-6-0	Ithaca	Herbert Broadwell	6-4-0
California Poly (SLC)	Sheldon Harden	9-5-0	Jamestown	Sid Grande	8-7-0
California State (Pa.)	Paul Ross	5-7-0	Junata	Jack Vanneman	1-4-0
California	Bill Tomaras	5-5-0	Kansas State	Fritz Knorr	8-4-0
Capital	Fred Downing	1-5-0	Kenyon	Lester Baum	5-5-0
Case Tech	Claude Sharer	2-7-0	Kings Point	Clem Stralka	9-1-0
Casper	George Kelly	2-7-0	Knox	Harold Turner	7-1-1
Catholic U.	George George	1-8-0	Lafayette	Frank Eisenhauer	5-4-0
Central Michigan	Dick Kirchner	9-2-0	Lake Forest	Al Hanke	5-4-0
Chadron State	Harry Simonton	5-2-2	Lawrence	Bernie Heselton	5-2-0
Chattanooga	Andrew Nardo	7-0-0	Lebanon Valley	Charles Poad	2-7-1
Chicago Illinois	George Strand	2-4-2	Lehigh	Gerald Peman	7-5-0
Chicago	Donald Bengtson	3-6-1	Lewis & Clark	Fred Wilson	9-5-0
Chico State	Hal Petersen	1-8-0	Lincoln (Pa.)	Robert Gardner	3-7-0
Cincinnati	Glenn Sample	2-6-0	Linfield	Ial Smith	2-7-0
Citadel	John Guiton	6-1-1	Lock Haven State	Hubert Jack	7-5-0
C.C.N.Y.	Joseph Sapora	3-4-0	Long Beach State	Warren Boring	6-5-0
Clarkson Tech	John Hantz	2-7-0	Long Island Aggies	Robert Hartman	4-3-0
Coast Guard Academy	Frank Kapral	8-1-0	Loyola (Md.)	Richard Clem	4-5-0
Colgate	Harvey Potter	6-5-0	Luther	Ron Fretheim	4-6-1
Colorado Mines	Jack Hancock	8-4-1	Lycoming	Budd Whitehill	8-2-0
Colorado State Col.	John Hancock	8-4-0	Maclester	Gary Olson	5-2-0
Colorado State U.	Ollie Woods	5-6-0	Mankato State	R. G. Macias	6-5-0
Colorado	Maynard Skinner	4-10-0	Marquette	Barney Karpfinger	3-8-0
Columbia	Stanley Thornton	5-5-1	Marshall	Ed Prelaz	4-7-0
Columbia (Minn.)	Vernon Grinaker	1-9-0	Maryland	William Krouse	6-4-0
Connecticut	James Bauer	1-8-0	Maryville	John Davis	3-5-0
Cornell College	Barron Brenner	5-9-0	M.I.T.	Alexander Souzis	5-3-2
Cornell U.	E. J. Miller	10-1-0	Massachusetts	John Dougan	2-7-0
Cortland State	David Miller	5-4-0	Mesa JC	Don Govoni	6-4-0
C. W. Post	James Davey	5-4-0	Miami (O.)	Jay Fry	8-8-0
Dartmouth	William Craver	3-4-1	Michigan State	Fendley Collins	7-1-1
Davidson	Charles Parker	2-5-1	Michigan	Clifford Keen	9-2-0
Delaware	Alden Burnham	6-3-0	Millersville State	James Maurey	5-5-0
Denison	Donald Valdes	9-4-0	Minnesota	Wally Johnson	13-5-0
Denver	Will Howard	3-6-0	Minot State	Al Schultz	10-2-0
DePauw	Edwin Snavely	5-3-2	Monmouth	Joseph Peisek	9-0-0
Dickinson	Charles Ream	7-1-1	Montana State Col.	Keith Bowen	8-2-1
Dickinson State	Clayton Ketterling	2-6-2	Montana State U.	Harold Wallace	7-3-0
Drexel Tech	Doug Frey	4-2-1	Moorhead State	Bill Garland	11-1-0
Dubuque	Kenneth Mercer	11-0-0	Moravian	Paul Kuklentz	9-1-0
Duke	Carmen Falcone	4-5-0	Muhlenberg	Carl Frankent	3-7-0
Eastern Illinois	Harold Pinther	10-2-0	Muskingum	Charles Kruzac	8-1-1
Eastern Michigan	Russell Bush	3-8-0	Nbraska	William Smith	0-13-0
East Stroudsburg	James Reed	4-7-0	New Mexico	Willie Barnes	2-8-0

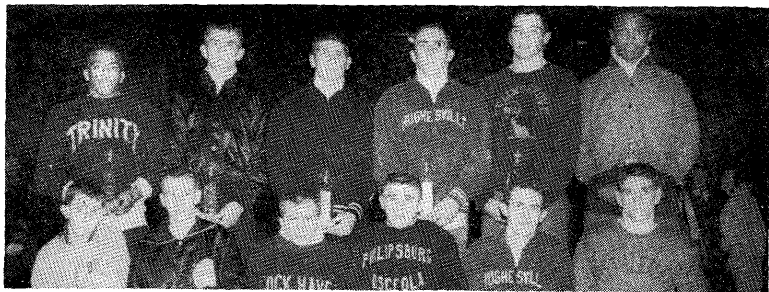


1960 DUAL MEET RECORDS

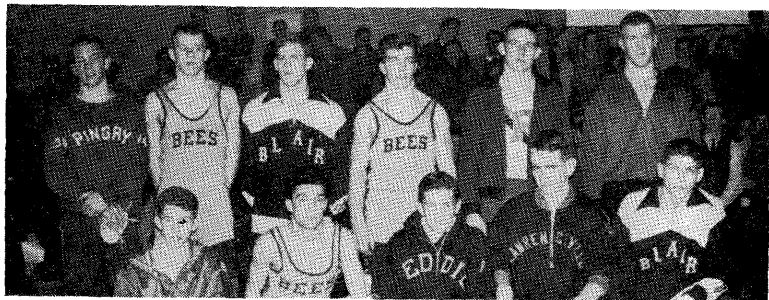
Record	School	Coach	Record	School	Coach	Record
4-6-0	North Carolina St.	Al Crawford	2-3-1	South Dakota State	Warren Williamson	7-3-0
0-11-0	North Carolina	Sam Barnes	3-9-0	Southern Illinois	James Wilkinson	6-1-1
3-6-0	North Dakota State	Tom Neuberger	6-5-1	South, U. of	Horace Moore	1-4-0
4-6-0	North Dakota	Henry Lasch	0-10-0	Springfield	Doug Parker	11-1-0
8-3-0	Northern Illinois	Bob Brigham	6-4-1	Stanford	Jack McKenna	4-4-0
2-6-0	Northwestern	Ken Kraft	6-2-2	Stevens Point State	E. S. Brodhage	4-5-0
7-4-0	Northwest Missouri	H. D. Peterson	9-2-0	Stout State	Bernard Kane	4-4-1
2-9-0	Notre Dame	Thomas Fallon	5-5-0	Superior State	Mertz Motorelli	1-5-0
2-5-0	Oberlin	George Giampetro	1-6-1	Swarthmore	Gomer Davies	6-2-1
3-7-0	Ohio State	Casey Fredericks	7-7-1	Syracuse	Joe Scandura	8-5-0
5-6-0	Ohio U.	Fred Schleichler	3-4-0	Temple	John Rogers	3-3-1
1-5-1	Ohio Wesleyan	Ray Leech	3-8-0	Thiel	Mel Berry	9-1-0
10-0-0	Oklahoma State	Myron Roderick	14-0-0	Toledo	Joseph Scalzo	2-4-0
0-6-1	Oklahoma	Tommy Evans	13-2-0	Toronto	J. L. Amos	2-4-0
3-6-1	Ontario A&V	Dean Burchett	4-4-0	Trinidad State JC	Bob Weher	5-5-0
3-4-0	Orange Coast JC	Dean Nevins	6-2-0	Tufts	Sam Ruggieri	3-6-0
3-3-0	Orange County JC	Dale Thomas	15-3-1	UC, Santa Barbara	Adran Adams	1-9-0
4-4-0	Oregon State	George Miller	5-1-0	Union College	Bruce Allison	5-4-0
6-2-1	Oregon Tech	Mike Reuter	6-5-0	Upper Iowa	William Rettko	6-3-0
3-11-0	Oswego State	David See	5-3-0	Ursinus	Richard Schellhase	2-6-1
4-7-0	Otterbein	Nicholas Vigilante	3-3-0	Utah State	Harlan Swanson	0-10-0
12-3-0	Pacific	George Tallchief	2-6-0	Utah	Marvin Hess	7-2-1
6-3-2	Parsons	C. Joslin	0-8-0	Valley City State	Vern Gale	5-3-0
4-4-1	Penn Military	H. Sveinbjornsson	2-7-1	V.M.I.	Tom Massie	5-4-0
6-4-0	Penn State	Charles Speidel	9-0-1	Virginia Tech	Frank Teske	4-1-0
8-7-0	Pennsylvania	Charles Ridenour	4-6-0	Virginia	Frank Finger	3-6-1
5-4-0	Pfeiffer	Wallace Martin	3-0-1	Wabash	Fred Pipin	4-5-0
5-5-0	Pittsburgh	Rex Peery	7-1-1	Wake Forest	Clarence Peters	0-8-0
9-1-0	Portland State	Howard Westcott	11-3-0	Wartburg	Norm Johansen	4-6-1
7-1-1	Princeton	James Reed	3-6-0	Washington & Lee	Richard Miller	7-2-0
5-4-0	Purdue	Claude Recek	0-6-1	Washington State	Myron Newell	9-1-0
5-2-0	R.P.I.	Norb Smalling	9-3-1	Washington	Ted Bredehoft	5-6-1
7-5-0	Ricks	Carl Bair	7-2-1	Waynesburg	Raymond Murdock	7-2-0
9-5-0	Ripon	Edgar Pieper	2-6-0	Wayne State U.	Phil Yanoschik	1-8-0
4-4-1	River Falls State	Byron James	10-2-1	Wesleyan	Nathan Osur	6-3-0
3-7-0	Rochester Tech	Earl Fuller	10-1-0	West Chester State	Willard Trezise	8-2-0
2-7-0	Rochester	James Cargoni	1-7-0	Western Illinois	H. C. Ave	1-5-0
9-5-0	Rutgers (Newark)	Phillip Pagliaro	1-4-0	Western Maryland	Ken Mohlenrich	2-8-0
3-7-0	Rutgers	Richard Voliva	7-5-0	Western Michigan	Roy Wietz	6-3-0
6-5-0	St. Cloud State	Willis Wood	11-1-1	Western State	Tracy Borah	9-3-0
4-3-0	St. John's (Minn.)	Jim Kuelbs	9-4-1	West Virginia	Stephen Harriek	9-2-0
1-6-1	St. Olaf	Chuck Lunder	5-4-0	Wheaton	George Olson	7-2-0
1-2-0	St. Thomas	James Gallagher	3-8-0	Williams	Pete DeLisser	1-6-0
1-9-0	St. Vincent	Jerry Hughes	0-5-0	Winona State	Robert Jones	12-2-1
1-5-0	San Bernardino Valley	Bob Smith	14-1-1	Wisconsin	George Martin	3-6-0
1-8-0	San Diego State	Harry Broadbent	5-1-1	Wittenberg	George Davis	1-8-0
1-0-0	San Francisco State	Joe Verducci	2-3-0	Wooster	Phil Shippe	3-4-0
1-1-0	San Jose State	Chesley Anderson	7-2-0	Worcester Poly	Ramon Scott	3-5-1
1-1-0	Saskatchewan	William Corman	5-4-0	Wyoming	Everett Lantz	10-1-0
1-1-0	Shippensburg State	Asa Wiley	3-7-0	Yale	John O'Donnell	6-4-0
1-1-0	Slippery Rock	Homer England	2-10-0	Yeshiva	Henry Wittenberg	2-8-0



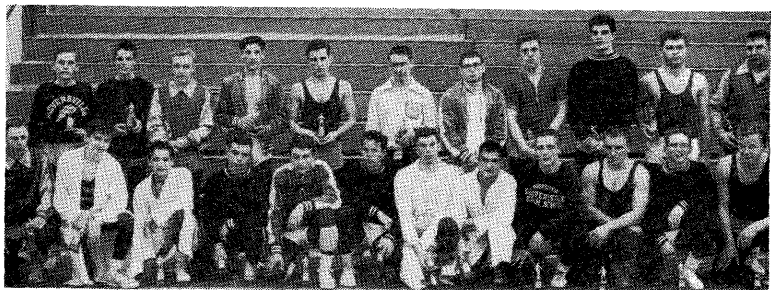
IOWA CONFERENCE CO-CHAMPION-WARTBURG: Left to right-Bill Smith, Coach Johansen, Mueller, Hassman, Hildebrandt, Scharnhorst, Don Smith, Sternberg.



**PENNSYLVANIA CHAMPIONS:** Left to right, front row—Bell (Columbia), Haise (Erie Strong Vincent), Johnson (Lock Haven), Twoey (Phillipsburg-Osceola), Fraley (Hughesville), Koch (Bethlehem); back row—Reese (Trinity), Carr (Hanover), Eisenhower (Bald Eagle Nittany), Hall (Hughesville), Dauberman (Selinsgrove), Nance (Indiana).



**NEW JERSEY INDEPENDENT SCHOOL STARS:** Left to right, front row—Liebert (Adm. Farragut), Armenante (St. Benedict's), Atkiss (Peddie), Harding (Lawrenceville), Baumann (Blair); back row—Hyde (Pingry), O'Connor (St. Benedict's), Meinig (Blair), Mocco (St. Benedict's), Hughes (Pennington), Savidge (Hunn).



**N.Y. SECTION II FINALISTS:** Left to right, front row (runners-up)—Uline (Ballston), Crow (Linton), Vrooman (Burnt Hills), Dobies (Mont Pleasant), Stratton (MP), Dinsmore (L), Crow (L), Recesso (Gloversville), Jasinski (Draper), Sutherland (BH), Rogers (D); back row (champions)—Simonson (G), Marcotte (Corinth), Martini (MP), D'Alessandris (D), Reed (S. Glens Falls), Fischerelli (Albany) missing, DeMeo (MP), Staulters (Saratoga), Juliano (BH), Male (MP), Haskell (B).

# SCHOLASTIC REVIEWS

## Alabama

By **SWEDE UMBACH, Coach, Auburn University**

A capacity crowd watched Benjamin Russell High School win six individual titles in the Alabama State High School championships. Coach Charles Lee, winning his second state title, had eight wrestlers in the finals. Four former champions successfully defended their crowns—Jim Mann, 103-pounds, Leroy Vines, 133-pounds, Henry Starnes, 138-pounds, and Gary Tucker, unlimited.

**TEAM SCORING**—Benjamin Russell 99, West End 75, Fairfield 56, Gadsden 54, Clift 32, Hewitt-Trussville 24, Guntersville 18, Hueytown 15, Enterprise 6, Central 5.

**103-LB**—Mann (B) champion, Gillentine (W) 2nd, Paschall (C) 3rd, Wilson (HT) 4th; **112-LB**—Sellers (B), Sharpe (C), Hardy (H), Alexander (F); **120-LB**—Dennis (W), Riley (B), Downing (Ga), Starnes (Gu); **127-LB**—Wade (B), Clay (W), Wellingham (Ga), Walden (E); **133-LB**—Vines (F), Tarrant (HT), Hamilton (C), Long (Gu); **138-LB**—Starnes (B), Hicks (W), Flaia (F), Adams (Ga); **145-LB**—Kennedy (B), Patterson (Ga), Mason (Hu), Reese (W); **154-LB**—Statt (Ga), Wheeler (HT), Scarborough (W), Stimler (Gu); **165-LB**—Hicks (B), Atchison (W), Graben (F), Lake (Ce); **175-LB**—Smith (F), Moeling (B), Tetterton (W), Forney (Ga); **HVYWT**—Tucker (Ga), Hollifield (F), Hall (Gu), Lutha (C).

## Arizona

By **PAT PATTERSON, Coach, Yuma Union High School**

**TEAM SCORING**—Phoenix Union 72, Yuma 55, Tucson 52, Washington 43, West Phoenix 38, South Mountain 25, Camelback 18, Catalina 18, Central 17, Carl Hayden 13, North Phoenix 14, Pueblo 13, Rincon 12, Sunnyslope 9, Glendale 6, Scottsdale 6, Arcadia 4.

**95-LB**—Woods (R) champion, Rojas (PU) 2nd, Martinez (T) 3rd, Muench (SM) 4th; **103-LB**—Magosing (SM), Rollins (Wa), Ong (PU), Echeveste (NP); **112-LB**—Tapia (T), Cooper (Su), Bernal (G), Rowe (Cat); **120-LB**—Oglesby (WP), Fregozo (Y), Marks (Cen), Willingham (PU); **127-LB**—Garcia (PU), Wagner (Cam), Enriquez (Wa), Lukus (Cat); **133-LB**—Padilla (Wa), Rico (Y), Reynolds (Cen), Thyron (PU); **138-LB**—Pinson (T), Burnson (NP), Daniels (Y), Tanori (PU); **145-LB**—Pinnell (T), Phelps (PU), Tucker (Cat), Dayton (Wa); **154-LB**—Nelson (Wa), Fletcher (Y), Caraveo (PU), Keller (A); **165-LB**—Bryant (P), Groseclose (WP), Powell (PU), Ginn (CH); **175-LB**—Sanchez (PU), Ochoa (Y), Dainty (Cat), Davis (WP); **191-LB**—McFadden (Y), Winer (CH), Loops (Cam), Chandler (T); **Unl**—May (WP), Grantham (SM), Brown (Sc), Areghini (Cen).

## Northern California

Pleasant Hill entered the Northern California State Invitational tournament as a darkhorse with just four qualifiers, but each of Coach Galli's entries reached the finals, accumulating 45 points, enough to capture the team title from a well balanced field. One hundred forty schools in northern California participated in interscholastic wrestling this year. The annual tournament was held at the University of California, Berkeley.

Dennis O'Connell, 145 pounds, a repeat champion from Castro Valley, won the award as the tournament's outstanding wrestler.

**TEAM SCORING**—Pleasant Hill 45, Hanford 33, Camden 28, Turlock 27, Castro Valley 23, Madera 23, Roosevelt 22, Oakland 20, Castlemont 19, San Lorenzo 18, Delmar 16, Hayward 16, Modesto 15, North Salinas 14, Santa Cruz 14, San Mateo 14, Fresno 13, Sunnysvale Fremont 13, East Bakersfield 11, Gilroy 10, Tulare 9, Acalanes 9, Pittsburgh 8, Andrew Hill 7, Bullard 6, Oakland Fremont 6, South Bakersfield 4, Porterfield 4, Lincoln 3, Mt. Whitney 3, Arroyo 3, Arvin 3, Sonora 2, Chico 2, Durham 2, Miramonte 2, McClymonds 2, South San Francisco 2, Anderson 1, Hughson 1, James Lick 1, Washington Union 1, Livingston 1, McClane 1, Mt. Diablo 1, Oakland Tech 1.

103-LB—Rodriguez (R) champion, Martinez (EB) 2nd, Gutierrez (Pitt) 3rd, Figgs (Bull) 4th; 112-LB—Jones (Han), Cowell (PH), Miller (OF), Martinez (Cam); 120-LB—Raley (Mo), Kuritsubo (O), Whitmore (F), Valenzuela (De); 127-LB—Marquez (Mad), Euranius (PH), Aquilar (Han), Easley (T); 133-LB—Huerta (Hay), Tamoto (Cam), Patterson (Han), Wagoner (F); 138-LB—Benites (SL), Willburn (CV), Bigler (T), Carranza (Lin); 145-LB—O'Connell (CV), Vasquez (R), Allen (Mad), Sherbourne (SL); 154-LB—Regalada (SF), Hernandez (G), Stitt (T), Kimura (SJ); 165-LB—Foster (PH), Peoples (Cas), Hull (Cam), Bressler (Han); 175-LB—Holm (SM), Bruns (PH), Smith (Du), Rusuigno (De); 191-LB—Anderson (NS), McGrew (Tul), Stiles (Tur), Mechnam (Cam); HVYWT—Rogers (SC), Toll (Ac), Leon (De), Porter (O).

## Southern California

By FRANK CROSBY

Pacific High School of San Bernardino emerged as the new power in Southern California Wrestling by winning the championship held at Redondo High School. Mount Miguel High School captured the second place team trophy. Ninety-six schools entered the qualifying tournaments. Forty-four schools qualified contestants for the finals and twenty-nine of them scored at least one point in the finals.

This tournament has been held annually without interruption since 1924, but next year San Diego County Schools will have their own section of the California Interscholastic Federation and will hold their own, independent Championship Tournament.

**TEAM SCORING**—Pacific 37, Mt. Miguel 29, San Diego 26, Lincoln 24, Torrance 23, Redondo 18, Upland 18, California 17, Morningside 15, Sierra 15, Mira Costa 14, Culver City 13, Atascadero 13, El Sefundo 12, El Cajon 12, Norwalk 12, Western 12, South Torrance 10, Grossmont 10, Chino 9, Inglewood 8, Anaheim 6, Arroyo Grande 6, Leuzinger 5, Redlands 5, Bellflower 4, Hoover 4, Whittier 1, San Bernardino 1.

98-LB—Yanase (T) champion, Martinez (U) 2nd, Gosselin (MM) 3rd, Cantoni (G) 4th; 106-LB—Dempster (N), Dean (MC), Wold (An), Meek (H); 115-LB—Bennett (Li), Duran (T), Boyd (M), Petit (MM); 123-LB—Pickens (MM), Harris (ST), Hernandez (Ca), Brown (CC); 130-LB—Leavy (Li), Logans (SD), Lucas (RL), Boyd (M); 136-LB—Hasse (ES), Caldera (U), Knauss (Le), Lung (G); 141-LB—Brite (Ca), Taylor (P), Baxter (EC), Lewis (MM); 148-LB—Horan (W), Salcido (RO), Cooke (I), Becker (MC); 157-LB—Booker (SD), Michaelian (CC), Goedker (EC), Rubottom (MM); 168-LB—Tribble (P), Drotar (S), Davis (AG), Burgert (G); 183-LB—Potts (P), Cervini (RO), Bow (S), Hoffman (B); HVYWT—Nettleton (At), Sagouspe (Ch), Miller (M), Wolford (SD).

## Colorado

Montrose won its third straight Colorado prep wrestling championship in the state tournament at Aurora, nosing Grand Junction before a standing-room-only crowd of more than 3,000. Wray took the Division 2 title in a 3-team battle with defending champion Steamboat Springs and Thornton.

**TEAM SCORING: DIVISION 1**—Montrose 67, Grand Junction 65, Aurora 37, Fruita 35, Delta 31, Adams City 29, Arvada 25, Boulder 24, Greeley 24, North Denver 22, Alamosa 17, Loveland 17, Longmont 15, Englewood 14, Fort Collins 14, Pueblo South 14, Golden 13, Pueblo Centennial 12, Brighton 12, East Denver 10, Pueblo Central 7, Westminster 6, Fort Morgan 6, La Junta 5, Lamar 4, Palmer 3, Wason 2, Cortez 2, Littleton 2, Rock Ford 2, South Denver 2, Manual 1, West Denver 1, Grand Junction Central 1, Sheridan Union 1. **DIVISION 2**—Wray 40, Steamboat Springs 38, Thornton 37, Fort Lupton 28, Olathe 28, Brush 20, College High, Greeley 20, Meeker 18, Palisade 14, Florence 13, Evergreen 12, Rifle 12, Holly 11, Mapleton 11, Idaho Springs 10, Monte Vista 10, Del Norte 9, Hayden 9, Sargent 9, Gunnison 8, Yuma 8, Paonia 6, Jefferson 5, Bear Creek 4, Laporte 4, Louisville 3, Hotchkiss 2, Castle Rock 1.

### DIVISION 1

95-LB—Coco (GJ) champion, Head (D) 2nd, J. Maestas (M) 3rd, Lopez (Al) 4th; 103-LB—Valencia (F), A. Maestas (M), Jones (D), Garcia (AC); 112-LB—Dougherty (Au), Del Ponte (E), Sandoval (Br), Chandler (ND); 120-LB—Harrison (M), MacArthur (Au), Mahorney (Lov), Crider (F); 127-LB—Stryker (M), McCoy (GJ), Grenz (FC), Taylor (We); 133-LB—Archuleta (Go), Salazar (PC), Meador (GJ), Godby (M); 138-LB—Ruckman (GJ), Morgan (Lon), Seery (Gr), Harder (D); 145-LB—Rickard (Ar), Moore (M), Nation (GJ), Garner (Lov); 154-LB—Flasche (F), Battiste (Ar), Kaufman (Au), Reynolds (Gr); 165-LB—Lahr (ND), DeRock (AC), Troutt (Gr), Gossert (Bc); 180-LB—Hines (PS), Newman (GJ), Broughton (M), Kornick (Br);

HVYWT—Clyncke (Bo), Kreutzer (AC), Hinton (ED), Statt (Gr).

#### DIVISION 2

95-LB—Hein, (T) champion, Briggs (W) 2nd, Phillips (MV) 3rd, Anderson (SS) 4th; 103-LB—Counter (FL), Velasquez (DN), Romero (T), Martinez (CH); 112-LB—Saunders (O), Surber (IS), Appel (SS), Bostrom (B); 120-LB—Kinder (E), Eslinger (T), Gardner (SS), Hickman (Y); 127-LB—Oldfield (SS), Urano (FL), Tustin (W), Wood (MV); 133-LB—Fix (W), Gerace (Ma), Phelps (SS), Gallegos (La); 138-LB—Engle (W), Sheridan (Me), Schaffer (Pao), Schreiter (Lo); 145-LB—Snyder (R), Harris (T), Larson (CH), Veneges (FL); 154-LB—Riggs (Pal), Williams (Ha), K. Alles (CH), Vanner (CB); 165-LB—Keller (O), Hazen (Hol), Bedell (SS), Freeman (B); 180-LB—Mercer (B), Sealy (Me), Larsen (J), Newland (Y); HVYWT—Hay (F), Turner (S), Fulton (Gu), G. Alles (CH).

## Connecticut

By HUGH PACKARD, *President, C.I.W.A.*

Eighty boys from 12 member schools were seeded into the Third Annual State Tournament held at Choate School. In a series of exciting, hotly contested bouts, Loomis won the team trophy with three champions and three place winners, followed closely by Taft, with two champions and three place winners. Dick Dolce of Kingswood won the Ray Sparks Award for the best wrestler.

**TEAM SCORING**—Loomis 51, Taft 48, Kingswood 41, Choate 39, Cheshire 34, Kent 30, Suffield 22, Pomfret 13, Gunnery 12, American School for the Deaf 6, Greenwich High 5, Wooster 0.

115-LB—Dolce (Ki) champion, Walsh (T) 2nd, Fine (Che) 3rd, Metz (Cho) 4th; 121-LB—Pollard (Che), Marshall (Ki), DuBose (Cho), Farnham (S); 127-LB—White (Ke), Hitch (T), Crittenden (L), Rivera (ASD); 133-LB—Grannis (L), Del Conte (Che), Bienemann (S), Cavanaugh (Ki); 138-LB—Wright (T), Merson (Ke), Curtis (Ki), Kruh (L); 147-LB—Richmond (Gu), Choate (Cho), Von Helm (Che), Albert (ASD); 157-LB—Duncan (T), Withington (P), Ahlborn (Ke), Shephard (Ki); 167-LB—Wilbur (L), Brennan (Cho), Hammer (T), Harsch (P); HVYWT—Shay (S), Rivers (Cho), Coster (L), Stokes (Ke).

## Delaware

By DAVE TOMPKINS, *News Editor, University of Delaware*

St. Andrew's School of Middletown successfully defended its title in the Fourth Annual Delaware Interscholastic Wrestling Tournament conducted at the University of Delaware. Tournament director was Alden H. (Whitey) Burnham, Delaware University coach.

Although St. Andrew's, a pioneer in the sport in Delaware, has won all four tournaments, this year's decision was by the narrowest of margins, reflecting improvement in the calibre of wrestling throughout the state. The win was not assured until the last heavyweight match in the finals. Bill Ford, William Penn's 133-pounder, was selected the outstanding wrestler.

**TEAM SCORING**—St. Andrew's 72, Brandywine 69, Newark 65, Delmar 38, Conrad 38, Milford 36, Mt. Pleasant 36, William Penn 26, P.S. duPont 14, Claymont 10, Millsboro 5, Dover 4, Caesar Rodney 0.

95-LB—Watson (WP) champion, MacDonald (B) 2nd, Cugler (D) 3rd, Crumpler (Cl) 4th; 103-LB—Jones (Milf), Arensburg (SA), McVey (N), Walker (D); 112-LB—Brown (N), Steele (SA), Bastian (B), Corder (Milf); 120-LB—Brinton (SA), Hickman (B), Berger (PS), Houle (N); 127-LB—Terry (SA), Mammele (B), Dobson (Milf), Thomas (N); 133-LB—Ford (WP), Urquhart (N), Seningsen (B), Hayden (Milf); 138-LB—Harmer (N), Blatt (B), Comegys (Co), Fleming (MP); 145-LB—Baker (B), Bockoven (MP), Houston (SA), Davis (D); 154-LB—Nichols (MP), VanLuvanee (Co), Wampole (Cl), Kline (Milf); 165-LB—Toland (Co), Seefried (D), Hammond (SA), Fretz (Dov); 180-LB—Burton (N), Taylor (D), Smack (Milf), VanBrunt (MP); HVYWT—Stewart-Gordon (SA), Gooding (Con), Gladfelter (B), Duncan (PS).

## Georgia

By CLYDE PARTIN, *Athletic Director, Emory University*

Druid Hills High School, under new coach Johnny Menger, walked off with the championship trophy for the second straight year in the annual Georgia State High School Wrestling Championships held at the Emory University gymnasium. The

meet was under the auspices of the Georgia State High School Athletic Association and the Division of Physical Education and Athletics of Emory University.

A total of 132 wrestlers entered the tournament with twelve high schools represented. Over 1,000 fans witnessed the two day affair which included 84 matches on opening day and 48 matches on the final day.

**TEAM SCORING**—Druid Hills 99, North Fulton 57, Chamblee 55, Henry Grady 46, Roswell 39, Marist 33, Cross Keys 33, Briarcliff 33, Avondale 30, Westminster 16, Rossville 2, Tucker 0.

95-LB—Cristal (DH) champion, Fouts (Rosw) 2nd, Tremmel (M) 3rd, Rumble (G) 4th; 103-LB—Fogel (DH), Godlewski (B), Nash, Whitmire; 112-LB—Doneho (Rosw), Wein (C), Honey (CK), Wilkins (A); 120-LB—Taylor (CK), Lloyd (C), Freeman (B), Beall (G); 127-LB—Lacy (C), Short (A), Pond (NF), Haas (W); 133-LB—Morris (DH), Naples (B), Billerakis (G), Hunt (A); 138-LB—Jackson (DH), Ridley (W), Swanson (B), Waldrop (G); 145-LB—Moore (DH), Anderson (G), Brown (C), Smith (Rosw); 154-LB—Austin (NF), Farmer (CK), Tallant (A), Mitchell (W); 165-LB—Budd (DH), Finocchio (M), Whaley (NF), Carlisle (A); 180-LB—Davis (G), Szczey (NF), Carroll (M), Logan (DH); HVYWT—Boyd (NF), Harris (M), Covington (DH), Ayers (G).

## Idaho

By JIM GRIEVE, Caldwell High School

The 3rd Annual Idaho State Wrestling Tournament returned to Caldwell in 1960 with Boise regaining the title lost to Borah last year. Blackfoot again finished a close second. Twenty-six schools and 126 contestants participated.

**TEAM SCORING**—Boise 88, Blackfoot 75, Caldwell 47, Borah 40, Minico 40, Pocatello 37, Snake River 36, Idaho Falls 30, Teton 19, Bonneville 18, Marsh Valley 16, Lewiston 15, South Fremont 11, Mountain Home 10, Rigby 9, Malad 7, Marsing 6, North Fremont 5, Burley 1, Twin Falls 0, Buhl 0, Gooding State 0, Kuna 0, Donnelly-McCall 0, Grace 0.

95-LB—Kidwell—(L) champion, Stilson (Bor) 2nd, Hernandez (Bl) 3rd, Stimpson (Mi) 4th; 100-LB—Adams (Boi), Murray (Bor), Oswald (IF), Deschamps (Mal); 105-LB—Wells (Boi), Parris (SR), Rasmussen (T), Marshall (NF); 110-LB—Gray (Bor), Ruchti (Boi), Baldree (Bl), Parris (SR); 115-LB—Young (IF), Glenn (Mi), Barnes (Bor), Webb (SR); 120-LB—Price (Bl), Hooban (C), Christensen (T), Brown (Mar); 125-LB—Robinson (Bl), Labbee (P), Rundell (Boi), Hooban (C); 130-LB—Gordon (Bl), Bowers (C), Smith (MV), Chapple (Bon); 137-LB—Rogers (Bl), Rackham (R), Schnabel (Mi), Anderson (Mal); 144-LB—Rush (Mi), Kinney (SR), Neef (Boi), Schmidt (SF); 152-LB—Millward (P), Kellogg (Boi), Adams (SR), Neilson (IF); 160-LB—Dorris (Boi), Smith (Bon), Owens (SF), Bischoff (Bl); 170-LB—Stevens (Boi), Hall (MH), Clark (Bl), Bates (IF); 182-LB—Whelchel (C), Miller (MV), Hay (S), Harding (IF); HVYWT—Doss (P), Porter (C), Plumlee (Mi), Cook (Bon).

## Illinois

By CHUCK FARINA

East Leyden High School captured the first state wrestling title in its history. Individual champs, Sal Fuscone and Dennis Owens helped to pave the way for the team title. Down-state Pekin, with two individual champs and one runnerup, took second place honors while Waukegan High School followed closely behind.

A large field of over 134 downstate and Chicago area schools entered the tournament in district competition. Of this total, 80 schools qualified boys from the various sectionals for the state finals held at the University of Illinois.

**TEAM SCORING**—East Leyden 58, Pekin 38, Waukegan 36, Thornton 27, Evergreen Park 25, Oak Lawn 23, Morton 22, Lockport 22, New Trier 16, Evanston 16, Oak Park 16, North Chicago 15, Bloom 15, Blue Island 14, Fractional North 14, Crystal Lake 12, Carbondale 12, Prospect 10, Highland Park 10, Champaign 10, Maine East 9, La Grange 9, Glenbrook 8, Tilden 8, Moline 8, Niles 6, Arlington 5, Oswego 5, Sterling 4, Urbana 4, Palatine 3, York 3, Hinsdale 3, Crane 3, Jacksonville 3, Wood River 3, Lake Park 2, Granite City 2, Kewanee 2, Lanphier 2, Sandburg 2, Reavis 1, Rich 1, Lane Tech 1, Schurz 1, Chicago Vocational 1, Joliet 1, Fietshans 1, Savanna 1, Cahokia 1, Elgin 1.

95-LB—Griffith (EP) champion, Prentice (NT) 2nd, Foster (EL) 3rd, Devers (RF) 4th; 103-LB—Fuscone (EL), Artiz (Pr), Miller (RI), Plaskis (Os); 112-LB—Park

(Pe), Coffman (EL), Heniff (EP), Zaccone (Mo); 120-LB—DiDonato (Pe), Parker (HP), Jacobson (Mo), Shartle (A); 127-LB—Coniglio (OL), Brown (Lo), Galberth (Th), Hiken (NT); 133-LB—Lazzara (BI), Fiocca (Th), Anderson (W), Lyczak (GI); 138-LB—Owens (EL), Shipp (B), Ward (Ev), Wagner (RF); 145-LB—Gaston (W), Wilson (Mo), Miller (Th), Brown (Ch); 154-LB—Bay (W), Millard (Pe), Evans (OL), Isel (Ni); 165-LB—Isaacson (OP), Paar (CL), Monroe (EL), Randle (Th); 180-LB—Cosby (NC), Voss (Lo), Noe (ME), Johnstone (La); HVYWT—Hopp (FN), Kristoff (Ca), James (Ti), Forgiore (GI).

## Indiana

By R. S. HINSHAW

Indianapolis Wood High School won its first state wrestling championship. Southport was second and Indianapolis Broad Ripple third.

In the eight sectional meets, the first elimination matches, 73 schools were entered. The following week 192 individuals competed in the regionals for the right to enter the state meet, as first and second place winners qualified.

**TEAM SCORING**—Indianapolis Wood 32, Southport 27, Indianapolis Broad Ripple 24, Indianapolis Shortridge 22, Anderson 21, Bloomington 20, Muncie Central 17, Elkhart 14, Bloomington University 12, Hammond 12, East Chicago Washington 11, Franklin Twp. 11, Lafayette Jefferson 11, LaPorte 11, New Albany 10, Indianapolis Manual 8, Indianapolis Washington 8, South Bend Central 6, Ben Davis 4, Crawfordsville 4, Crown Point 4, Bishop Noll 4, Hammond Tech 4, Indianapolis Howe 4, Lawrence Central 4, South Bend Riley 4, Logansport 2.

95-LB—Smyser (S) champion, Waley (IM) 2nd, Scott (E) 3rd, Jackson (CP) 4th; 103-LB—Barnett (MC), Robinson (IS), Houston (BD), Rees (CP); 112-LB—Jackson (FT), DeLey (A), Floran (SBR), Mann (NA); 120-LB—Herald (BR), Seigel (IS), Welliever (C), Bowyer (LJ); 127-LB—Moore (IW), Ashman (S), Patterson (MC), Craft (L); 133-LB—Roman (BU), Rumpza (LJ), Ellis (LC), Weaver (E); 138-LB—Haley (H), Opp (IW), Marvel (HT), Loeper (IBR); 145-LB—Atkinson (IBR), Feiock (NA), Toweson (BN), Ruppe (SBC); 154-LB—Rodgers (ECW), Johnson (IW), Stark (IS), Davis (SBC); 165-LB—Bivens (A), Rawlings (B), Turnock (E), Jeter (IS); 175-LB—Boruff (B), Alexander (S), Gall (E), Connelly (SBC); HVYWT—McCrone (IW), Strieter (L), Lewellen (IH), Goodale (L).

## Iowa

By FINN B. ERIKSEN, Waterloo Public Schools

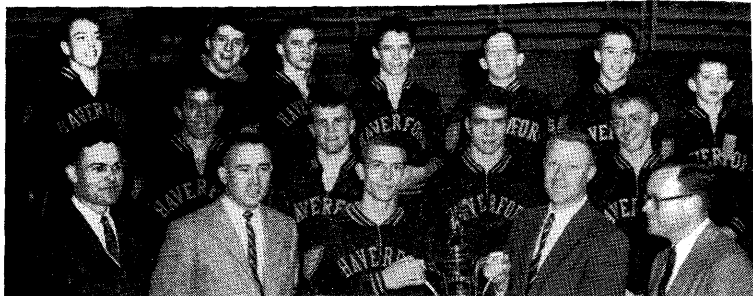
In a hotly contested tournament held at Iowa State Teachers College, Waterloo East High School won the Class "A" team championship, its fourth in seven years. Veteran Coach Dave Natvig's wrestlers out-distanced a determined Davenport team. The defending champion, Waterloo West, placed tenth.

Well-balanced and undefeated Cresco High School won the Class "B" team crown. This was George F. "Christy" Flanagan's second state championship team at Cresco in three years. Several schools had their first individual champions, among them Iowa City, Cedar Rapids, and Grinnell.

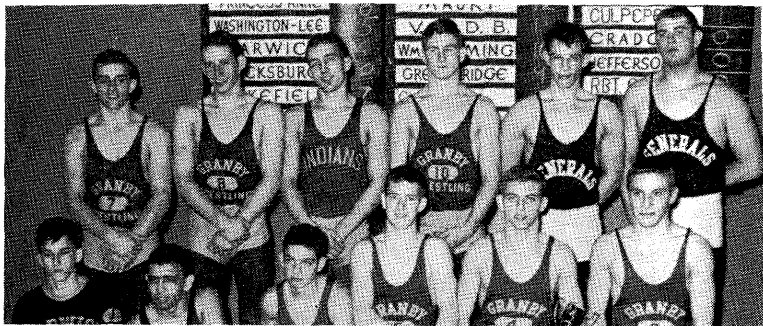
**TEAM SCORING:** CLASS A—East Waterloo 59, Davenport 53, Iowa City 43, Charles City 33, CR Jefferson 24, CR Washington 23, Newton 23, Muscatine 18, Grinnell 18, West Waterloo 13, Cedar Falls 12, CB Lincoln 12, Fort Dodge 6, Mason City 6, Bettendorf 6, Decorah 5, DM North 5, DM Lincoln 4, DM East 3. CLASS B—Cresco 68, Britt 58, New Hampton 46, Osage 20, Clarion 18, Eagle Grove 14, Waverly 13, Iowa Falls 13, Algona 12, Perry 10, Waukon 9, Maquoketa 9, Jesup 8, Leon 8, Bloomfield 5, Janesville 5, Audubon 5, Tama 3, Griswold 3, Hampton 3.

### CLASS A

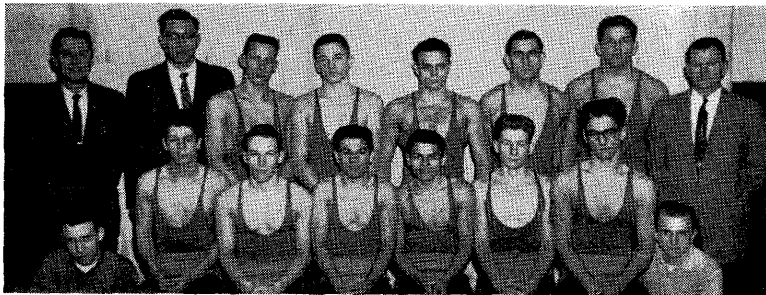
95-LB—Duff (EW) champion, Bleakley (N) 2nd, Bowe (Da) 3rd, Franz (B) 4th; 103-LB—Barmen (EW), Coleman (CRJ), Johnson (N), Musual (B); 112-LB—Robinson (EW), Weeber (IC), Owen (CRJ), Lovett (DML); 120-LB—Shirley (CC), Belwey (Da), McNeil (CRW), Barton (N); 127-LB—Buzzard (EW), Millage (M), Messerly (FD), Deppe (G); 133-LB—Mayo (G), Harold (CF), Kine (DMN), Slinger (CC); 138-LB—Leach (Da), Cool (EW), Matter (De), Hodge (CBL); 145-LB—Wieland (CRJ), Borden (Da), Krieger (MC), Sweet (CF); 154-LB—Westcott (IC), Roberts (Mu), Kohl (CRW), Eberly (WW); 165-LB—Gordon (CC), Franz (IC), Winter (CRJ), Nicholson (Da); 175-LB—Thompson (Da), Warnke (WW), Kingery (N), Brown (G); HVYWT—Conaway (CRW), Caldwell (IC), Palmer (CC), Tuinstra (DME).



**HAVERFORD SCHOOL—PHILADELPHIA INTER-ACADEMIC CHAMPION:** Left to right, front row—Baker (Dir. of Athletics), Coach Buckley, Burnham (capt.), Hartel (tournament director), Dixon (hon. dir.); middle row—Cromwell, Hunt, Clarke, Bentz; back row—Scott, Kimball, Jacobs, Buell, Geer, Nance, Oehrle.



**VIRGINIA VICTORS:** Left to right, front row—Fletcher (Warwick), Seymour (Wash.-Lee), Raines (Blacksburg), Powell (Granby), Simons (Granby), Leffew (Granby); back row—Jordan (Granby), Callahan (Granby), Stone (Blacksburg), Radford (Granby), Wulfsburg (Wash.-Lee), Flesch (Wash.-Lee).



**BEST IN THE BUCKEYE STATE—GARFIELD HEIGHTS:** Left to right, front row—Kastralenis, Musarro, Steely, Palmisano, Biinato, Zukrajsek, Wiskoff, Lisy; back row—Williams, Kurimski, Sokol, Predouat, Linke, Dlugas, Krassiecki, Morris.



## CLASS B

95-LB—Schmauss (C) champion, Rohrer (EG) 2nd, Lloyd (B) 3rd, Lundberg (O) 4th; 103-LB—Steenlange (B) Deichtman (NH), Pollard (O), Rubendahl (CI); 112-LB—Schmauss (C), Sebert (CI), Fuller (J), Hansell (L); 120-LB—Hassman (NH), Henry (C), Michaelson (EG), Conway (B); 127-LB—Peckham (C), Block (M), Johnson (NH), Mumm (J); 133-LB—Etherington (AI), Deutsch (NH), Jorgensen (Au), Kahl (B); 138-LB—Randall (O), Briner (W), Hill (CI), Cormaney (H); 145-LB—Egorenko (C), Hibbs (NH), Krull (B), Muller (G); 154-LB—Hochhaus (B), Hartley (W), Sage (L), Quigley (T); 165-LB—Smith (B), Reiter (P), Saunders (Ja), Ackerman (W); HVYWT—Campbell (IF), Buhr (C), Bonner (BI).

## Kansas

By BERT HITCHCOCK, *Coach, Oakley High School*

For the first time since 1950 the team championship was won by a school outside the Northwest Kansas League. Douglass took its first title since 1930 when the State Wrestling Tournament was begun in Kansas.

**TEAM SCORING**—Douglass 54, Goodland 50, St. Francis 34, Wichita East 28, Hoxie 27, Wichita Southeast 23, Hutchinson 22, Oberlin 21, Norton 19, Topeka 16, Russell 15, Newton 14, Colby 13, Oakley 11, Wellington 11, Kinsley 10, St. Johns (Salina) 9, Salina 8, Wichita West 7, Wichita North 3, Winfield 3, Kansas School for Blind 1, El Dorado 1, Clay Center 1, Wichita South 1, Atwood 0, Garden City 0, Highland Park 0, Liberal 0, Manhattan 0.

95-LB—Hawsk (G) champion, O'Fallon (SJ) 2nd, Johnson (WE) 3rd, Lewis (T) 4th; 103-LB—Martinez (Ne), Plummer (Oa), Reynolds (D), Demoret (Hu); 112-LB—Myers (D), McClung (G), Unruh (WE), Carter (WN); 120-LB—Keller (SF), Rumbach (Ho), Myers (D), Seay (We); 127-LB—Aherlick (D), Bird (No), Wickliffe (Hu), Bandel (SF); 133-LB—Newell (G), Kent (No), Wegman (Ho), Cheynet (WSE); 138-LB—MacFee (Ob), Wright (D), Nixon (WW), Tucker (WE); 145-LB—Todd (G), Davison (K), DeMoss (We), Sater (Ob); 154-LB—Isernhagen (SF), Mosier (Ho), Oliphant (WSE), Miller (Wi); 165-LB—Metzler (C), Wagner (R), Ritterhouse (S), Metz (D); 180-LB—Walters (T), Baughman (Hu), Tinkler (R), Isernhagen (SF); HVYWT—Wellman (WSE), Freeman (WE), Long (Ob), Thomas (G).

## Maryland

By CHARLES R. GAMPER, *Gilman School*

The 39th Annual Wrestling Tournament, after a two-day delay because of a snow-storm, was the largest ever held. Seventeen schools competed, 14 with full teams. Crowds were large, averaging 1200 a session. Although Carver was one of the favorites, it had not been felt they would make a runaway of the meet as they did. Best wrestler was George Jackson, Carver 154-pound champion.

**TEAM SCORING**—Carver 49½, Dunbar 29, McDonough 24, Gilman 22, Southern 19½, Mervo 13½, Poly 11½, Douglas 8, St. Joseph 7½, Severn 7, Edmondson 6½, Friends 3, City 2, Patterson Park 2, St. Paul 0, Calvert Hall 0, Loyola 0.

112-LB—Loverde (M) champion, Pierson (G) 2nd, Nash (Ca) 3rd, Buppert (McD) 4th; 120-LB—Durant (Ca), Delaney (So), Fisher (G), Carrington (Du); 127-LB—Bradshaw (McD), Ch. Richardson (Ca), Moore (Do), Wells (CI); 133-LB—Davis (Du), Madison (E), Kesmodel (Se), Schillip (SJ); 138-LB—Merrick (Ca), Ellerman (P), Caskey (G), Haws (McD); 145-LB—Saulsbury (Du), Riley (SJ), Cl. Richardson (Ca), Jansen (P); 154-LB—Jackson (Ca), Leach (G), Sakalleris (P), Lord (F); 165-LB—Prince (Du), Milligan (So), Knight (Ca), Triebel (Se); 175-LB—Tellington (So), Waddell (McD), M. Brown (Ca), Johnson (PP); HVYWT—Kyle (McD), Lasek (M), R. Brown (Do), Spangler (P).

## 8th Annual Washington Metropolitan Tournament

By BOB McNELIS, *Coach, Northwood*

Northwestern High School of Hyattsville, Maryland, coached by John J. McNelis won the team title. Northwestern has never finished lower than third place.

More than 2000 fans witnessed the final round.

**TEAM SCORING**—Northwestern 83, Suitland 71, Episcopal 62, Annapolis 55, St. Albans 52, Gaithersburg 40, Walter Johnson 32, Northwood 31, Blair 24, Bethesda 18, High Point 15, South Hagerstown 14, Southern 10, Landon 5, Wheaton 3.

95-LB—Warrs (BCC) champion, McEwan (La) 2nd, Jones (No) 3rd, Chamberlain

(Ga) 4th; 103-LB—Chesley (NW), Shephard (No), Dove (Su), Ranev (Bl); 112-LB—Pierson (SA), Tyrell (NW), Claggett (Ga), Kearns (SH); 120-LB—Donaldson (No), Jones (NW), Morris (Su), Banks (So); 127-LB—Pickeral (Su), Hamilton (NW), Katchef (An), Collis (Bl); 133-LB—Moser (SA), Whiton (NW), Winfield (Ep), Littelford (Su); 138-LB—Wathen (SA), Sanders (NW), Walker (Ga), Lee (BC); 145-LB—Winfield (Ep), Lewnes (An), Tiddy (Su), Suott (Bl); 154-LB—Lytle (WJ), Stewart (Ep), Alton (An), Young (HP); 165-LB—Ferguson (Ep), Simmons (An), Scholz (SA), Confer (HP); 175-LB—Ferguson (Su), Bennett (An), Lewis (Bl), Fields (WJ); HVYWT—Berdot (Ga), Johnson (NW), Fitzhugh (Ep), Hardisty (So).

## Michigan

By FENDLEY COLLINS, *Michigan State University*

Iggy Konrad's Lansing Sexton Team successfully defended its team championship by a narrow margin over runner-up, Ypsilanti.

**TEAM SCORING**—Lansing Sexton 70, Ypsilanti 64, Kalamazoo 57, Battle Creek 39, Berkeley 33, East Lansing 33, Lansing Eastern 31, Port Huron 27, Jackson 26, Ann Arbor 23, Garden City 20, Detroit Thurston 18, Niles 17, Bay City Handy 15, Farmington 9, East Grand Rapids 7, Owosso 6, Hazel Park 5, Lansing Everet 5, Bay City Central 4, Pontiac Central 4, Adrian 3, Walled Lake 3, Warren Fitzgerald 3, Dearborn 2, Melvindale 2, Dearborn Edsel Ford 1, Dearborn Fordson 1, Livonia Bentley 1, Pontiac Northern 1, Southfield 1, Trenton 1.

95-LB—Kurchak (BCH) champion, McGraw (GC) 2nd, Gillum (Y) 3rd, Gilbert (LEa) 4th; 103-LB—Cwikhowski (PH), Smith (BC), Ridout (Y), Long (EL); 112-LB—Payne (LS), Drouillard (PH), Rogers (BC), Holden (LEv); 120-LB—Dozeman (K), Swagler (LS), Wilbanks (Y), Seipke (BC); 127-LB—White (B), Hopkins (LS), Taylor (BC), Latora (K); 133-LB—Mulder (LS), Cross (AA), Cassell (F), Johns (LEa); 138-LB—Thigpen (BC), Bow (Y), Bair (LEa), Gleason (B); 141-LB—Williams (J), Arvin (Y), Roberts (LS), Van Hofe (AA); 154-LB—Post (DT), Marvin (K), Barham (J), Toomey (LS); 165-LB—Hill (Y), Hannah (EL), Winegart (N), Crockett (GC); 180-LB—Bontrager (K), Florence (B), Boles (LS), Stuber (LEa); HVYWT—Roop (EL), Davis (K), Taylor (Y), Romence (EGR).

## Minnesota

By R. G. MACIAS, *Coach, Mankato State*

Alexander-Ramsey of St. Paul, coached by Ken Bergstedt, won the Minnesota State High School Tournament. Ramsey qualified six wrestlers and five placed.

Thus the state championship stays in Region 4 for the second straight year. Mankato and Redwood Falls finished in a tie for runner-up honors.

Gary Erdman, Mound 135-pounder won his third straight title, while Jerry Byers, Mankato 95-pounder, Ray Brees, Blue Earth 120-pounder, and Don Christ, Mankato 154-pounder won their second straight.

One hundred forty-four individuals representing 64 schools were entered. Hundreds of fans were turned away the final night, and a new attendance record of 6,129 paid admissions was set.

Wrestling continues to grow in Minnesota as 28 new schools participated for the first time this year. One hundred sixty schools entered District Tournaments.

**TEAM SCORING**—Alexander-Ramsey 46, Mankato 35, Redwood Falls 35, Blue Earth 28, Hibbing 23, White Bear Lake 22, Albert Lea 21, Owatonna 20, U. High 18, St. Cloud 17, Mound 17, Mounds View 16, Robbinsdale 16, Aitkin 14, Grand Rapids 12, Faribault 12, Washburn 12, Anoka 11, Waseca 10, Richfield 10, Montevideo 10, Austin 9, Tracy 9, Crosby-Ironton 8, Hastings 8, Brainerd 6, Benson 4, Pipestone 4, North 3, Grand Meadow 2, Rochester 2, Winona 2, Fridley 1, Glenwood 1, Hutchinson 1, Morris 1, Moorhead 1, North St. Paul 1.

95-LB—Byers (Ma) champion, Bizal (Hi) 2nd, Robbins (SC) 3rd, Leopold (RF) 4th; 103-LB—Erdman (Mou), King (RF), Gale (AR), Paajanen (Ai); 112-LB—Quaday (Re), Boerner (Ri), Mauseith (O), Tift (AR); 120-LB—Brees (BE), Lucas (Was), Groth (Ha), Paulson (Rob); 127-LB—Winther (AR), True (Au), Schwartz (Fa), Iverson (Be); 133-LB—Kennedy (AL), Hanlon (Ai), Leopold (RF), Cavin (U); 138-LB—Lyden (MV), Nelson (U), Prouty (T), Manion (P); 145-LB—Olson (WBL), Schrom (SC), Zeug (RF), Kramer (Br); 154-LB—D. Christ (Ma), Blumenthal (WBL), Girgen (Ha), Lillemoe (Mon); 165-LB—Hendrickson (AR), Bassett (Rob), G. Christ (Ma), Patton (Fa); 175-LB—Rognie (Wash), Matson (GR), Rogowski (AR), French (An); HVYWT—Schrodt (O), Frye (Hi), Thompson (AL), DeCent (CI).

## Missouri

By **MORRIS BLITZ**, *Normandy High School*

After eliminations in four district tournaments, the finals of the Missouri State High School Championships were held at Riverview Gardens High School. A thrilling tournament found Coach John Moore's Ritenour team winning for the thirteenth consecutive year, by one point over Hap Whitney's Normandy Vikings. The tournament was decided in the unlimited class when Normandy's heavyweight lost in an overtime tie which called for a referee's decision.

**TEAM SCORING**—Ritenour 59, Normandy 58, Maplewood-Richmond Heights 42, Ferguson 37, Missouri School for the Blind 26, Afton 23, Riverview Gardens 22, Webster Groves 20, Kirkwood 20, Lindbergh 16, O'Fallon Technical High School 14, John Burroughs 13, Ladue 13, University City 12, Kemper Military Academy 8, Missouri Military Academy 6, North Kansas City 5, St. Louis High School 4, Vashon 4, Wentworth Military Academy 3, Central 1, Clayton 0, Jennings 0, Lafayette 0, Parkway 0.

**95-LB—Burst (JB)** champion, Huddleston (K) 2nd, Szuch (F) 3rd, Meyer (M) 4th; **103-LB—Guilliams (R)**, Caldwell (F), Taber (A), Scott (V); **112-LB—Mueller (R)**, Farhat (O), Zulpo (RG), Stewart (WG); **120-LB—Piel (MSB)**, Mancuso (M), Beukemann (A), Nichols (F); **127-LB—Kaller (R)**, Mattingly (M), Smith (N), Schrempf (Li); **133-LB—Blanner (M)**, Campbell (K), Jag (Li), Bradford (WM); **138-LB—Lorenzini (RG)**, Dickson (L), Wilson (MMA), Sargin (NKC); **145-LB—Tocco (N)**, Beattie (F), Breeding (M), Harris (O); **154-LB—Adams (MSB)**, Stewart (WG), Hoffmann (F), Mellor (RG); **165-LB—Simpson (N)**, McIntyre (R), Schroer (WG), Rosenthal (UC); **180-LB—Hartzell (R)**, Sissom (N), Fitzgerald (US), Kramer (SLH); **HVYWT—Jehnelt (A)**, Seaton (N), Soper (KMA), Beal (Li).

## Montana

By **JUG BECK**, *Missoula County High School*

The 5th Annual MHSAA Tournament held at Missoula attracted nearly 200 contestants from 19 schools. Missoula, with 6 individual champions and one runner-up, won the AA team championship, while Custer of Miles City dominated the A, B, and C schools. Only two of five defending champions retained their crowns. Stine and Cates each won a third championship for Missoula. Don Rebal of Great Falls won the quick fall trophy with a 27-second pin, and Dave Golden, Missoula, was awarded the outstanding wrestler plaque.

**TEAM SCORING**—AA—Missoula 112, Great Falls 93, Bozeman 53, Flathead 47, Butte Public 44, Butte Central 24, Billings 11, Helena 8, Park 2, A, B, C—Custer 59, Glasgow 28, Hardin 21, Dawson 17, Sidney 7, Malta 6, Polson 2, Havre 2, Great Falls Central 2, Browning 0.

**95-LB—Davis (M)** champion, Rebal (GF) 2nd, Lee (F) 3rd, Dinsmore (BP) 4th; **103-LB—Lockwood (GI)**, Morin (M), Harris (BP), Rice (Ha); **112-LB—Stine (M)**, Sicotte (BP), Crosby (C), Markle (GI); **120-LB—Cates (M)**, McIntyre (GF), Orested (C), Spain (Bo); **127-LB—Jones (BC)**, Remington (GF), Daniels (M), Friestone (D); **133-LB—Pankratz (GF)**, Heggen (F), Gillespie (BC), Korkalo (M); **138-LB—Clark (M)**, Kostohris (GF), McGrath (BP), Wall (C); **145-LB—Golden (M)**, McHenry (Bo), Olson (F), Baldwin (GF); **154-LB—Rowland (GF)**, Miller (F), Krutzfeldt (C), Ciabattari (BP); **165-LB—Nash (M)**, Thomas (C), Denton (Bo), Foss (S); **180-LB—Habel (GF)**, Ross (Bo), Hunton (C), Robinson (F); **HVYWT—Ross (Bo)**, Marks (Ha), Coe (He), Schlepp (C).

## Nebraska

Omaha South, coached by Mickey Sparano, won their fifth straight Nebraska state title for an unprecedented record. The South team has run up 65 wins without a loss in dual meet competition.

Bob Van Outry of Omaha South, was the only state champion to repeat.

**TEAM SCORING**—Omaha South 107, Omaha North 70, Bellevue 38, Boystown 33, Lincoln North East 32, Lincoln High 30, Grand Island 25, Lincoln South East 24, Omaha Central 12, Omaha Tech. 12, Sidney 12, Scottsbluff 6, Fremont 5, Gering 4, Alliance 0, Cozad 0, Curtis 0, Kearney 0, Kimball 0, West Kearney 0.

**95-LB—Jerry Newville (OS)** champion, Billy Meyers (ON) 2nd, Ewing (SB) 3rd, Snook (LNE) 4th; **103-LB—Bottoroff (OC)**, Talmon (OS), Campos (GI), Dappen (LN); **112-LB—Walenz (ON)**, Charley (Be), Martin (L), Allgood (LS); **120-LB—Homan (ON)**, Alexander (OS), Langdon (S), Rodwell (LS); **127-LB—Fuxa (OS)**,

Reynolds (BE), Netwig (ON), McIntyre (LS); 133-LB—De George (OC), Eitel (L), Jackson (B), Machan (GI); 138-LB—McWilliams (L), Anglim (OS), Wright (B), Gillette (LN); 145-LB—Swanberg (OS), Clatterbuck (BE), Nutzman (F), Grossman (LN); 154-LB—Gorgen (OS), Linder (GI), Dula (BE), Fox (LS); 165-LB—Raschke (ON), Olsen (OT), Crumby (BT), Printz (S); 175-LB—Van Outry (OS), Devers (BT), Thompson (LN), Van Wey (GI); HVYWT—Hollingsworth (ON), Murphy (LN), Gillespie (LS), Rogers (G).

## New England

By **FERRIS THOMSEN, JR., Rivers Country Day School**

Thirty-one schools entered 132 wrestlers in the twelfth Annual New England Interscholastic Tournament held at Needham High School, Needham, Mass.

Phillips Academy of Exeter, New Hampshire, won the team trophy with 54 points. Dennis Kearney of LaSalle Academy was awarded the "Cy" Carlson Trophy, as the outstanding wrestler.

**TEAM SCORING**—Exeter 54, LaSalle 40, Loomis 31, Needham High 27, Cheshire Academy 22, Kingswood 15, Providence Country Day 14, Browne & Nichols 13, Governor Dummer 13, Tabor 13, East Providence High 12, Andover 12, Milton Academy 10, Cranston High 7, Worcester Academy 3, Mt. Pleasant High 3.

115-LB—Doice (K) champion, Fine (CH) 2nd, Pezza (CR) 3rd Ramos (EP) 4th; 121-LB—Pollard (Ch), Chace (PCD), Davis (N), Riccetti (La); 127-LB—Luz (La), McGaughey (E), Cocroft (PCD), DeFazio (N); 133-LB—Grannis (Lo), Pierannunzi (EP), Jackson (N), Kellner (W); 138-LB—Kearney (La), Schwanda (MP), McClave (E), Curtis (K); 147-LB—Martin (E), McAlear (N), Caplan (B&N), Cerra, Joe (La), 157-LB—Lyman (GD), Saltostall (E), Schoepfer (B&N), DiMilio (MP); 167-LB—Lawrence (A), Wilbur (Lo), Thompson (E), Cerra, John (La); 177-LB—Plumpton (E), (Schmidt (Lo), Palmisciano (La), Van de Graaff (B&N); HVYWT—Kakas (T), Pappas (M), Spinney (La), Dionne (N).

## New Jersey

By **HENRY BORESCH, Coach, Newton High School**

Newton High School won the 27th Annual Tournament held at Rutgers University. The Donald Ringer Trophy for the outstanding wrestler went to Joseph Zelasny of Bound Brook.

A trophy given by the Wrestling Coaches and Officials Association in honor of Harry E. Lake was presented to the winning coach.

Harry Lake was Coach, Athletic Director, and later, Supervisor of Health and Physical Education, in the Union Public Schools, and directed this Tournament for twenty-six years.

**TEAM SCORING**—Newton 34, Union 32, Morristown 26, Cranford 20, Fairlawn 20, Somerville 19, Washington 17, Bound Brook 12, Rahway 11, Watchung Hills 11, Collingswood 10, Dover 10, Westfield 10, Dayton Regional 9, Vineland 9, Woodbury 9, Phillipsburg 8, Teaneck 6, Hunterdon Central 5, North Hunterdon Regional 4, Pascask Valley 4, North Plainfield 2, Paulsboro 2, Roselle Park 2.

98-LB—L. Terranova (N) champion, Lucariello (DR) 2nd, Hicks (S) 3rd, Lane (HC) 4th; 106-LB—R. Terranova (N), Cabal (Wa), Branch (F), Petrozelli (DR); 115-LB—Zelasny (BB), DeSanti (V), Leek (Co), Berman (T); 123-LB—D'Orio (F), Prior (Cr), Tuttle (S), BerTocchi (V); 130-LB—Powers (We), Wilson (N), McCormick (NH), Ciariarello (BB); 136-LB—Sarinelli (D), Sykos (P), Calasurdo (V), Mosman (Co); 141-LB—Lilley (V), Grossi (N), Rudolph (T), Maden (Pa); 148-LB—Reid (S), Koerber (V), Reichert (Cr), Lackemeyer (HC); 156-LB—Olesen (Wa), Sica (Mo), Mausner (Co), Lewis (RP); 168-LB—Vjerira (W), Blackes (M), Crevari (F), Tull (Wa); 178-LB—Pauser (WH), Craft (Cr), Barends (Wa), Finn (Ra); HVYWT—Wikander (M), Joworowich (Ra), Pelsang (PV), Busnack (NP).

## New Jersey Independent Tournament

By **EVERETT W. NEWCOMB, JR., Coach, Pingry School**

St. Benedict's Prep of Newark won its third straight team championship, including three individual titles in the ninth annual New Jersey Independent School Wrestling Championship at the Pingry School of Elizabeth. Chris Atkiss of Peddie won the outstanding wrestler's trophy.

**TEAM SCORING**—St. Benedict's 64, Blair 43, Peddie 41, Hun 34, Lawrenceville 31, Pingry 21, Pennington 18, Admiral Farragut 16, Bordenont Military Institute 15.  
**103-LB—Leibert (AF)** champion, Locasio (SB), 2nd, Rose (H) 3rd, Ravich (BI) 4th;  
**112-LB—Armenante (SB)**, Klup (P), Strecker (L), Bohorquez (AF); **120-LB—Atkiss (P)**, Stouck (L), Everett (AF), Johannsen (Pi); **127-LB—Harding (L)**, Keffer (H), Fox (Pen), Zarroli (Bo); **133-LB—Baumann (BI)**, Wahl (SB), Bpnello (P), D. Hilgendorff (Pi); **138-LB—Hyde (Pi)**, Furlong (L), G. Coker (SB), B. Goodman (BI); **145-LB—O'Conner (SB)**, Scully (Bl), Farmer (Bo), Sindal (P); **154-LB—Meinig (BI)**, Pallant (SB), P. Hilgendorff (Pi), Churchill (L); **165-LB—Mocco (SB)**, Pete Savidge (H), Schmitt (Pe), Fraser (P); **175-LB—Hughes (Pe)**, Blowers (Bo), Slader (P), Speir (H); **HVYWT—Paul Savidge (H)**, Smith (P), Scotti (SB), Steinhart (BI).

## New Mexico

By **BOB ADAMS**, Sandia

Sandia High School of Albuquerque rolled to its first state high school championship, as Albuquerque Highland finished a close second.

The title was undecided until the last match when Harry Kerns, Sandia, decisively defeated Frank Salat, Highland, 3-1, in the heavyweight class.

Daryl Smith, 168-pound champ from Aztec, was named outstanding wrestler.

**TEAM SCORING**—Sandia 105, Highland 101, Albuquerque High 80, Aztec 63, Albuquerque Rio Grande 43, Los Alamos 23, Albuquerque Valley 17, Alamogordo 15, Las Vegas Robertson 14, Las Cruces 13, Santa Fe 8, Gallup 2, Raton 0.

**98-LB—Holman (Az)** champion, Davidson (S) 2nd, Gee (H) 3rd, Abeyta (V) 4th;  
**106-LB—J. Borthwick (H)**, Ayzee (AH), Cloves (S), Contreras (Ala); **115-LB—Sanchez (RG)**, B. Borthwick (H), Martinez (S), Robles (AH); **123-LB—Parker (Az)**, Guitierrez (RG), Bramlett (AH), Pappas (H); **130-LB—Wright (S)**, Moore (H), Hardy (AH), Pacheco (R); **136-LB—McDavid (H)**, Sandoval (AH), Burnett (S), Wingfield (LA); **141-LB—Trussell (H)**, Grostette (RG), Baca (AH), Lancaster (R); **157-LB—Korn (H)**, Richard (La); **168-LB—Smith (Az)**, Schropp (S), Rodd (H), Bell (LA); **183-LB—Ambriz (AH)**, Byrd (S), Rumsey (Ala), Ward (H); **HVYWT—Kerns (S)**, Salat (H), Huggins (LC), Sutterfield (V).

## New York—Section I

The annual Section I tournament was held at Horace Greeley High, Chappaqua. White Plains' Bob Horton was awarded the outstanding wrestler's trophy, as Scarsdale gained a share of its third successive title by tying New Rochelle.

**TEAM SCORING**—New Rochelle 46, Scarsdale 46, White Plains 38, Fox Lane 36, Yorktown Heights 30, Rye 28, John Jay 15, Mahopac 12, Horace Greeley 11, Lincoln 8, Hastings 8, Wappingers Falls 3.

**103-LB—Berson (WP)** champion, Peterson (FL) 2nd; **112-LB—B. Lansky (S)**, Dawd (YH); **123-LB—T. Lansky (S)**, Wright (R); **127-LB—Crocetto (NR)**, Romano (YH); **133-LB—Wilson (JJ)**, Rubin (NR); **138-LB—Barrett (NR)**, Simpson (WP); **145-LB—Gladioux (S)**, La Regina (FL); **154-LB—L. Skinner (FL)**, A. Clarke (YH); **165-LB—Fowler (HG)**, Austin Clarke (YH); **180-LB—Castegner (M)**, Meyers (NR); **HVYWT—Horton (WP)**, Cohmos (L).

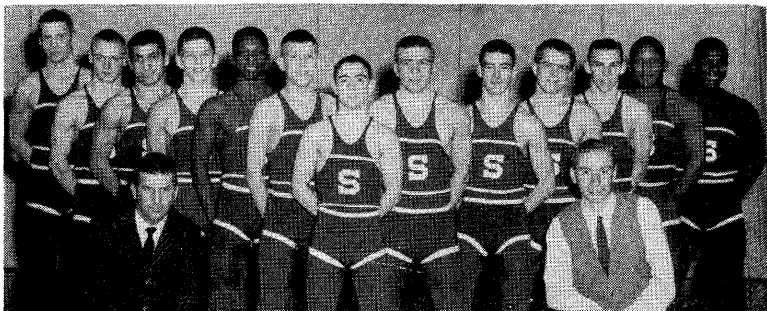
## New York—Section II

By **PETER R. SHULHA**, Linton High School

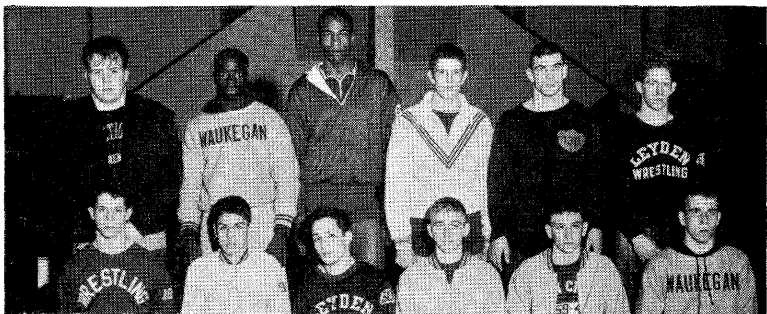
The 2nd New York State Section II Wrestling Championships were held at Linton High School, Schenectady. There were nineteen schools represented, six more than last year. Mont Pleasant of Schenectady coached by Larry Mulvaney repeated in first place in the Class "A" division; Draper, coached by Austin Leahey, took the Class "B" title from Saratoga, South Glens Falls, coached by Andy McGriffin, copped Class "C" honors. Boyce, Staulters, DeMeo and Haskell were repeat champions.

**TEAM SCORING: Class A**—Mont Pleasant 79, Linton 60, Gloversville 40, Albany 20. **Class B**—Draper 64, Burnt Hills 62, Ballston Spa 46, Saratoga 36, Scotia 15, Beth-lehem Central 9, Miskayuna 8, Mohaneson 4, Shaker 0. **Class C**—South Glens Falls 43, Corinth 19, White Hall 15, Lake George 6, Warrensburgh 3, Glens Falls 2.

**98-LB—Simonson (G)** champion, Vline (Bal) 2nd, Middleton (D) 3rd, Jackson (Mi) 4th; **106-LB—Marcotte (C)**, Arthur (Sc), Berhaupt (L), Wood (SGF); **115-LB—Boyce**



**MICHIGAN'S REPEAT TITLEHOLDER—LANSING SEXTON:** Left to right, front row—Coach Konrad, Gemmill (mgr.); back row—Fitzgerald, Roberts, Toomey, Hansen, Hopkins, Crumley, Wilcox, Mulder, Payne, Bunn, Swagler, Boles, Johnson.



**ILLINOIS PREP RULERS:** Left to right, front row—Lazarra (Blue Island), Griffith (Evergreen Park), Fuscone (East Leyden), Park (Pekin), DiDonato (Pekin), Bay (Waukegan); back row—Hopp (Fractional North), Gaston (Waukegan), Cosby (North Chicago), Coniglio (Oak Lawn), Isaacson (Oak Park), Owens (East Leyden).



**OMAHA SOUTH-NEBRASKA LEADER FIVE CONSECUTIVE YEARS:** Left to right, front row—Newville, Tabmon, Alexander, Fuxa, DeGeorge, Anglim, Gorgen; back row—Coach Sparano, Swanberg, Tesar, Van Outry, Limas, Hawkins (trainer), Milan (mgr.).

(Bal), Crow (L), Adrience (D), Cain (MP); **123-LB**—Martini (MP), Vrooman (BH), Kincaid (LG), Brachett (Bal); **130-LB**—D'Allsendris (D), Dobies (MP), Thompson (G), Hawley (BC); **136-LB**—Reed (SGF), Stratton (BH), Monaco (MP), Truesdale (L); **141-LB**—Fischerelli (A), Dinsmore (L), Cahill (MP), Kislawski (D); **148-LB**—DeMeo (MP), Crow (L), Phillips (Sa), Recesso (G), Tones (BH), Wood (SGF); **168-LB**—Ivliano (BH), Jasinski (D), Mariucci (WH), Rakvica (D), DeFillippo (L); **HVYWT**—Haskell (Bal), Rogers (Sa), Brushac (Sa), Jacobie (SGF).

## New York—Section III

By **GEORGE R. STALEY, Rome**

The Section III Wrestling Tournament was held at Rome, New York. The team championship was won by Frankfort-Schuyler with Watertown High School runner-up.

**TEAM SCORING**—Frankfort 44, Watertown 42, West Genesee 31, Oneida 31, Ilion 26, Mohawk 25, Cazenovia 25, Auburn 24, Rome 23, Baldwinsville 21, Marcellus 19, U.F.A. 18, Whitesboro 18, Fulton 16, Herkimer 15, Lowville 14, Richfield Springs 14, Mexico 12, Oneonta 12, Central Square 12, Little Falls 10, Cooperstown 11, North Syracuse 11, VanHornesville 9, Holland Patent 8, Sauquoit 8, Chittenango 7, Carthage 6, Clayton 5, Vernon-Verona Sherrill 4, Camden 4, General Brown 3, Indian River 2, Proctor 1, Skenevatona 1.

**98-LB**—Mitch (W) champion, Wanzereid (CR) 2nd; **106-LB**—Roberts (A), Forward (WG); **115-LB**—G. Jones (I), Zupan (C); **123-LB**—B. Jones (I), Dodd (Caz); **130-LB**—Perling (Onei), Grates (Fr); **136-LB**—Perschino (B), Blaisett (Onco); **141-LB**—Annese (N), Dupee (W); **148-LB**—Osborne (W), L. Cari (Fr); **157-LB**—Huxtable (RS), Trauato (Fu); **168-LB**—Shaut (Mo), Wetmore (L); **183-LB**—Bielby (R), Hunt (Ma); **HVYWT**—Evans (UFA), Schwasnich (LF).

## New York—Section IV

By **JAMES R. HOWARD, Windsor High School**

Ithaca High School retained its hold on the team championship, although pushed to the very end of the 14th annual Section IV tournament by a strong Windsor team. Chuck Bush of Windsor became the first wrestler ever to win four sectional titles, as he defended successfully at 112-pounds.

**TEAM SCORING**—Ithaca 84, Windsor 73, Vestal 50, Greene 50, Chenango Forks 45, Horseheads 37, Cortland 31, Elmira South Side 27, Binghamton North 25, Homer 23, Chenango Valley 21, Sidney 18, Oswego 15, Elmira Free Academy 13, Bainbridge 13, Newark Valley 12, Union Springs 12, Waverly 9, Elmira Heights 8, Dryden 8.

**95-LB**—J. Shiel (Wi) champion, Turco (I) 2nd, Bercher (ESS) 3rd, R. Haskell (CF) 4th; **103-LB**—Benninger (I), W. Bush (Wi), D. Wilcox (V), D. Hall (CV); **112-LB**—C. Bush (Wi), Walker (V), Prudence (I), Middaugh (ESS); **120-LB**—Franciamone (I), O'Reilly (N), Orr (G), Ettenberger (Hor); **127-LB**—Drietzier (I), G. Wilcox (V), Robbins (G), Stocker (N); **133-LB**—Bell (Hor), Houper (ESS), Capra (G), Williamson (V); **138-LB**—Kohlback (Wi), Blye (I), Barry (V), Murray (O); **145-LB**—Whittaker (G), Smith (Hor), Simonds (B), Homer (V); **154-LB**—Stephens (CF), Iacovelli (I), Mahalak (Hor), Harrington (G); **165-LB**—Everling (CF), Hall (CV), Winterstein (N), Ma (Wa); **180-LB**—Whitney (Wi), Watts (Hor), Anderson (C), Packer (CF); **HVYWT**—Tesori (C), Shippos (I), Sherwood (G), Grannis (V).

## New York—Section V

By **ROBERT F. LAYS, W.C.O.A. Secretary-Treasurer, Section V**

Three titles were won by Penn Yan Academy wrestlers in Class A Individual Wrestling Championships at Geneva High School. In a battle of champions, Tom Smith, Madison 120-pound winner last year, pinned Augie Cavallette last year's 127-pound champ from Hornell. Bill Brooks of Geneva won his 58th victory in four years as he squeaked by Edison's Charles Caleo. Twenty-four teams from Central-Western New York entered.

Although record breaking snowfall in the area threatened postponement of the event, 25 schools took part in Class competition. Attica and Canisteo each won four crowns. Heavyweight Gary Hale won his third consecutive championship.

**TEAMS: CLASS A**—Penn Yan, East, West, Wellsville, Geneva, Edison, Madison, Hornell, Franklin, Corning Free Academy, Corning Northside, Monroe, Canandaigua, Jefferson. **CLASS B**—Letchworth, Honeoye Falls, Attica, Wayne, Odessa, Canisteo, Waterloo, Dansville, Arcade.

## CLASS A

95-LB—D. Marchionda (PY) champion, Camelio (Wes) 2nd; 103-LB—L. Marchionda (PY), Scarlata (E); 112-LB—Protz (E), Covell (W); 120-LB—Brooks (G), Caleo (E); 127-LB—Smith (Ma), Cavallette (H); 133-LB—Turner (F), Carlino (CFA); 138-LB—Brinson (PY), Mosier (Mo); 145-LB—McGowan (Ma), Domm (C); 154-LB—Billone (J), Atkinson (G); 165-LB—Weaver (Wes), Brockway (CN); 180-LB—Targaglia (Wes), Johnson (CF); HVYWT—Gridley (CN), Abbey (Ma).

## CLASS B

95-LB—Bannister (L) champion, Lewis (HF) 2nd; 103-LB—Eek (A), Deisenroth (W); 112-LB—Burg (A), Switzer (W); 120-LB—Teeter (O), Stewart (C); 127-LB—Green (C), Goodman (Wat); 133-LB—Makitra (C), VanDeViere (W); 138-LB—Allen (D), Hopkins (Ar); 145-LB—Stewart (C), Harter (D); 154-LB—Wheeler (A), Mahony (D); 161-LB—Lemieux (WL), Shearing (L); 180-LB—Ferrington (Ar), Ross (D); HVYWT—Hale (L), Banner (HF).

## New York—Section VI

The Section VI Wrestling Tournament was held March 3-5. The AAA Tournament was held at Kenmore Junior High School and the A-B schools wrestled in their respective classifications at Southwestern Central School. The AA Tournament was held at Iroquois Central on March 3rd and 5th.

## CLASS AAA

TEAM SCORING—Williamsville 116, Amherst 77, Kenmore West 73, Frontier 40, West Seneca 34, Cleveland Hill 27, Kenmore East 21, Tonawanda 4.

98-LB—McKeever (W) champion, Fowler (C) 2nd, Cohen (A) 3rd, Bratek (F) 4th; 106-LB—Brown (W), Richardson (WS), Kalp (KW), Osborne (A); 115-LB—Jackson (A), Schlicht (C), Kalp (KW), Hammond (F); 123-LB—Fodor (WS), Cohen (A), Eberl (W), Matthews (KE); 131-LB—McKeever (W), Gellman (KW), Stuhr (WS), Steen (A); 136-LB—Zimmerman (KW), Worden (W), Terwillinger (F), Sciler (A); 141-LB—Miller (W), Clift (KW), Brown (C), Eckman (F); 148-LB—Donohue (W), Everard (F), McNerny (KW), Fay (A); 157-LB—Wade (KW), Whitman (W), Wardour (A), Herdic (WS); 168-LB—Fraunhofer (KE), Sabo (A), Miller (W), Brown (C); 183-LB—Ernest (W), Hartney (A), Armone (KW), Muench (T); HVYWT—Prior (F), Pawlowski (A), Cox (KW), Weigel (W).

## CLASS AA

TEAM SCORING—Iroquois 118, Maryvale 61, Orchard Park 55, Medina 54, Lancaster 34, Lake Shore 15, Hamburg.

98-LB—Rathman (O) champion, Newell (I) 2nd, Nicotra (Ma) 3rd, Alberts (LS) 4th; 106-LB—Cursons (I), Clark (Me), Davis (H), Starr (Ma); 115-LB—Dantly (Me), Schoenthal (I), Novick (H), Berg (L); 123-LB—Farr (O), Pawlowski (Ma), Basher (L), Hinton (LS); 130-LB—Zielinski (I), McMillan (L), Nieman (Ma), Polar (Me); 136-LB—Andolina (Ma), Sang (O), Whitman (H), Best (I); 141-LB—Stanley (O), George (Me), Willard (I), Stuhlmiller (H); 148-LB—Wadell (I), Nelson (L), Eingeier (H), Roos (Ma); 157-LB—Schroeder (I), Brigham (Me), Valentic (Ma), Allen (LS); 168-LB—Balcerzak (I), Rusert (H), Payne (Me), McDonald (O); 183-LB—Bateman (Ma), Schoenthal (I), Hogg (LS), Quick (H); HVYWT—Bennet (I), Lyons (L), Farrell (Me), Brunner (O).

## CLASS A

TEAM SCORING—Gowanda 75, Falconer 68, Southwestern 38, Salamanca 36, Alden 32, Eden 23, Depew 22.

95-LB—Scholeno (F) champion, Boss (G) 2nd, Basher (D) 3rd, Niles (S) 4th; 103-LB—Waddingrn (F), Murphy (S), Gordon (G), Aphorpe (SW); 112-LB—Haggart (G), Vollenine (F), Kasmarek (D), Jordans (A); 120-LB—Barton (SW), Meyer (G), Petz (D), Hallberg (F); 127-LB—Dallas (F), Ross (G), Thorpe (SW), Szpila (A); 133-LB—Kempff (A), Cooney (S), White (G), Sandeen (SW); 138-LB—Vandewark (F), Miller (SW), Holcomb (G), Smith (S); 145-LB—Sturm (A), Marrano (G), Bolles (F), Lindstrom (SW); 154-LB—Jennings (D), Gerfluk (F), Engel (E), Tietz (G); 165-LB—M'Carthy (G), Bradley (E), Quattrone (S), Gardner (A); 180-LB—Williams (E), Capron (SW), Lewis (G), Snow (S); HVYWT—Sternad (G), Larson (SW), Wright (S), Fisher (A).

## CLASS B

TEAM SCORING—Cassadaga Valley 87, Randolph 70, Cattaraugus 68, Silver Creek 43, Pine Valley 31.

95-LB—Graftstrom (CV) champion, Offerbeck (C) 2nd, Huben (PV) 3rd, Inklev (R) 4th; 103-LB—Beckwith (R), Sharpe (CV), Denny (SC), Carver (PV); 112-LB—Evans (C), Milliman (R), Stanford (CV), Berry (PV); 120-LB—Sampsell (CV), Frentz (C), Kuhns (R), Bolling (SC); 127-LB—Eskeli (R), Clarke (PV), Schultz (CV), Bull (SC);



133-LB—Stanz (R), Fancher (PV), Frost (SC), Becker (CV); 138-LB—Anderson (CV), Herzog (C), Merrill (PV), Baker (SC); 145-LB—Harvey (CV), Nash (PV), Cook (SC), Maus (C); 154-LB—Parr (R), Millward (CV), Burst (SC), Case (C); 165-LB—Agliatta (SC), Nichols (CV), Waldon (R), Ruper (C); 180-LB—Prince (C), Parmant (CV), Wood (SC), Page (R); HVYWT—Hill (C), Westley (CV), Noyes (SC), Priess (R).

## New York—Section VII

By KEN DAVIES, *Chairman*

The climax of the Section VII season was the sectional tournament in which 74 wrestlers competed. Peru Central captured seven individual titles and Saranac Central took five.

**TEAMS**—Saranac Central, Peru Central, Keeseville, Altona.

98-LB—Fountain (P) champion, Lamay (S) 2nd, Gonyea (S) 3rd, McGee (P) 4th; 106-LB—Norcross (S), Gadway (S), Sears (P), Christenson (K); 115-LB—Lamay (S), Goddeau (S), Kennedy (P), Crayer (P); 123-LB—Ezro (P), F. Blair (S), R. Blair (S), Laundree (C); 130-LB—S. Sorrell (P), G. Rivers (S), Hackett (S), Bosley (A); 136-LB—Rudmin (P), L. Blair (S), B. Rivers (S), Bosley (A); 141-LB—Sorrell (P), Carter (S), Provost (S), Buckley (K); 148-LB—Marshall (S), Longtemps (S), Keenan (P), LaDuke (P); 157-LB—Besette (S), Brault (S), Morrow (P), Wright (P); 168-LB—Latour (P), Hicks (P), Tedford (S), Hackett (S); 181-LB—St. John (S), Yasment (S), Dunrey (P), LaBounty (K); HVYWT—Phillips (P), Martin (P), Cane (S), LaPorte (S).

## Central New York

By LEON HANNIGAN, *Vernon-Verona-Sherrill*

**TEAM SCORING**—Frankfort 54, Oneida 49, Rome 40, Canastota 35, Cazenovia 23, Richfield Springs 14, Vernon-Verona-Sherrill 13, Sauquoit 8, Chittenango 8, Camden 7, Whitesboro 6, Holland Patent 4, Auburn 0, Van Hornsville 0.

98-LB—Haslauer (O) champion, Hannas (Can) 2nd; 106-LB—Sportello (F), Tackabury (Can); 115-LB—Zupan (Can), LaMonica (F); 123-LB—Barbuto (F), Dodd (Caz); 130-LB—Perling (O), Grates (F); 136-LB—Manore (F), VanStrander (O); 141-LB—Burlingame (Caz), Sanborn (R); 148-LB—Moyer (O), Licari (F); 157-LB—Spargo (R), Hustable (RS); 168-LB—Grizzuto (F), Herzog (VVS); 183-LB—Bielby (R), Monaco (O); HVYWT—Mastracco (R), Masucci (Can).

## Western North Carolina Association

By W. C. CLARY, *Secretary*

**TEAM SCORING**—Thomasville 88, Asheboro 69, Mooresville 60, Wilkes Central 59, Statesville 58, Albemarle 49, Kannapolis 9.

95-LB—Jackson (T) champion, Owens (WC) 2nd; 103-LB—Hall (WC), Parker (M), Furr (Al), K. Ferguson (T); 120-LB—Johnson (S), Richardson (T); 127-LB—Linker (M), Lambeth (T); 133-LB—Robertson (M), Eanes (T); 138-LB—Hamilton (As), Mauldin (Al); 145-LB—Gambill (WC), D. Ferguson (T); 154-LB—Mills (S), Redding (As); 165-LB—Frazier (WC), Tysinger (T); 175-LB—Sullivan (S), Williams (T); HVYWT—Thomas (As), Grubb (T).

## North Carolina

By STEVE GABRIEL, *Coach, Appalachian High School*

Nineteen schools participated in the 1960 tournament with a total of 196 wrestlers. Twenty other teams in the state did not enter.

Myers Park's Paul Stork, winner of the 167-pound class, was awarded the Outstanding Wrestler trophy. Bill Rutledge of Goldsboro, Doug Carson, Ray Critcher, and Carl Smith of Appalachian successfully defended their championships.

**TEAM SCORING**—Appalachian 119, Myers Park 44, Thomasville 43, Asheboro 37, Mooresville 36, Page 31, Greensboro 26, High Point 26, Greensville 25, Burlington 21, Salisbury 17, Beaver Creek 15, Southwest 13, Statesville 11, Goldsboro 11, Lexington 8, New Bern 7, Kinston 5, Glenn 0.

95-LB—Watson (Ap) champion, Fesperman (M) 2nd, Jackson (T) 3rd, Graver (B) 4th; 103-LB—Cricher (Ap), Parker (M), Aiken (As), Fear (B); 112-LB—Moretz (Ap),

McCaskill (P), Lee (Sa), Owens (Grv); 120-LB—Smith (Ap), Johnson (St), Buchanan (Grb), York (As); 127-LB—Boyer (SW), Cook (Ap), Kirkman (Grz), White (HP); 133-LB—Bockout (P), Robertson (M), King (Ap), Sargent (MP); 138-LB—Carson (Ap), Hamilton (As), Hollfield (MP), Gregg (HP); 145-LB—Rutledge (Go), Maddock (MP), Wilcox (BC), Ferguson (T); 154-LB—Cook (Ap), Mills (St), Redding (As), Bowman (SW); 165-LB—Stork (MP), Watson (Grb), Tysinger (T), Powers (K); 175-LB—Sullivan (St), Frank (Go), Fountain (Grv), Williams (T); HVYWT—Wilson (Ap), Cook (HP), Thomas (As), Hill (Grb).

## North Dakota

By HAROLD PEDERSEN, Coach, Williston High School

Bismarck High School, coached by Gerald Halmrast won its first state wrestling title. Thirty-one schools entered the four regionals. Four former champions successfully defended their crowns: they were Ron Privratsky, Alan Huns, Duane Pekas, and Dave Stewart of Williston who won his third straight title.

**TEAM SCORING**—Bismarck 76, Dickinson 49, Williston 46, St. Mary's of New England 40, Minot Model 32, Grand Forks 30, Minot 24, Assumption Abbey, Richardson 19, Valley City 18, Bismarck St. Mary's 16, Lisbon 14, Dickinson Campus 12, Napoleon 9, Harvey 7, Hettinger 6, Fargo Shanley 4, Wahpeton 3, Columbus 0, Fargo 0, Jamestown 0, Mandan 0.

95-LB—Arnsen (W) champion, Cram (B) 2nd, Pankratz (D) 3rd, Zwick (VC) 4th; 103-LB—Privratsky (D), Kellar (StB), Grabou (B), Dailey (VC); 112-LB—Stewart (W), Wandler (NE), Biven (GF), Stockert (D); 120-LB—Liszt (GF), Opstad (MM), Lindquist (D), Rismoen (M); 127-LB—Damanlow (DC), Cann (VC, Levitt (W), Stagl (NE); 133-LB—Bachmeier (NE), Schimke (MM), Randall (M), Kube (Wa); 138-LB—Huso (MM), Friestad (N), Unruh (B), Oberg (He); 145-LB—Hanson (B), Hamann (D), Seefeld (Ha), Heffron (StB); 154-LB—Pekas (NE), Lunde (GF), Schuler (B), Lies (AA); 165-LB—Heinen (AA), Newman (B), Opp (M), Nelson (W); 175-LB—Anderson (L), Fink (B), Boespflug (D), Dahl (W); HVYWT—Wagner (B), Reuter (W), Hauge (M), Cook (S).

## Ohio

By FRED SCHLEICHER, JR., Coach, Ohio University

Ohio's largest wrestling year ever was climaxed by Garfield Heights' winning the state crown in the Twenty-third Annual State High School Wrestling Tournament held at Ohio State University. One hundred seventy-six contestants, representing seventy-three schools, competed for individual and team championships.

**TEAM SCORING**—Garfield Heights 57, Maple Heights 49, Cleveland John Marshall 32, Bridgeport 32, Toledo Rogers 24, Martins Ferry 24, Whitehall 23, Lakewood 20, Euclid 18, Eastlake North 15, Parma 15, Canton McKinley 14, Mayfield Heights 13, Shaker Heights 13, Fremont Ross 13, Cleveland West 12, Worthington 11, Brush 10, Lisbon Beaver 9, Canton North 9, Toledo Whitmer 8, Bedford 8, Dayton Mad River 7, Clyde 7, Collinwood 6, Oberlin Firelands 6, Cleveland South 4, Columbus Franklin Heights 4, Toledo Macomber 3, North Macedonia 3, Massillon 3, Mantua Crestwood 3, Mentor 2, Kent State 2, Louisville 2, Ravenna Township 2, Cleveland St. Joseph 2, Toledo St. Francis 2, Upper Arlington 2, Linden McKinley 1, Fostoria 1, Cuyahoga Falls 1, Canton Timken 1, Cleveland Heights-1, Sandusky 1, Toledo Central Catholic 1, Warren Harding 1.

103-LB—Palmisano (GH) champion, McDaniel (MF) 2nd, Ansted (TW) 3rd, Sabo (CJM) 4th; 112-LB—Price (EN), Berry (W), Jones (MF), Schuall (Cl); 120-LB—Mooney (FR), Mooney (FR), Douglas (B), Douglas (B); 127-LB—Cunningham (B), DeJulius (MH), Coghill (Be), Gay (DMR); 133-LB—Joseph (W), Joseph (W), Hoppel (LB), Zanella (Co); 138-LB—DiDemonic (MH), DiDemonic (MH), Reader (Brsh.), Reader (Brsh.); 145-LB—Borczzs (MH), Borczzs (MH), Sokol (GH), Temple (OF); 154-LB—Houska (P), Houska (P), Bruney (MF), Davis (Wo); 165-LB—Linke (GH), Linke (GH), Perkins (CN), Perkins (CN); 175-LB—Rizk (CJM), Rizk (CJM), Orazen (E), Tennant (Wo); HVYWT—Solowin (TR), Woodie (MayH), Pappas (CW), Shearer (L).

## Oklahoma

Grady Peninger's Ponca City Wildcats won their second consecutive state title and crowned four individual champions in the state meet at Blackwell High School. A packed house of 2100 braved the winter's worst storm to witness the finals. Jack

Brisco, Blackwell heavyweight, won his third straight title and was voted the outstanding wrestler.

**TEAM SCORING**—Ponca City 75, Perry 62, Edmond 59, Blackwell 52, Putnam City 37, Tulsa Edison 31, Sapulpa 29, Geary 23, Stillwater 22, John Marshall 20, Northwest 19, Tulsa Central 19, Tulsa Rogers 16, Tulsa Webster 11, Bristow 10, Southeast 8, Guthrie 7, Capitol Hill 6, Midwest City 6, Del City 5, Oklahoma Military Academy 3, Tulsa Hale 2, Northeast 1, Okmulgee 1.

**98-LB—Coleman (Po) champion**, Reed (JM) 2nd, Summerall (TW) 3rd, Bryan (E) 4th; **106-LB—Deupree (Pu)**, Rogers (E), Powers (SE), Matthews (P); **115-LB—Smith (Po)**, Pinkley (E), Alcock (TE), McAdams (JM); **123-LB—Murray (Pu)**, Faw Faw (P), Blair (E), Sells (Ge); **130-LB—Wilson (Po)**, Reding (St), Segress (E), Christian (NW); **136-LB—Karcher (P)**, Chesbro (St), D. Turnbull (Sa), Cromer (TC); **141-LB—Reding (Ge)**, Breece (Bl), Momsen (Gu), Brewer (TC); **148-LB—McBride (Pd)**, Alexander (P), Gay (TR), Deal (NW); **157-LB—Fry (TE)**, Newland (Bl), Fisher (Po), Manolakis (TC); **168-LB—Webb (P)**, Archer (Po), Stubblefield (Br), Harrison (NW); **183-LB—McDaniel (Bl)**, McKnight (Sa), LeCrone (TE), Black (Pu); **HVYWT—Brisco (Bl)**, Turnbull (Sa), Collins (E), Frolich (DC).

## Oregon

By JOHN H. EGGERS, Sports Publicity Director, Oregon State College

Sweet Home, runner-up a year ago, moved up a notch and easily won the 13th Annual State High School Wrestling Championship for class A-1 schools. The Huskies, coached by George Meyers, nearly doubled the point output of the nearest contender.

In competition among Class A-2 and B schools, Sutherlin, won its second successive team crown. A surprise runner-up was St. Francis of Eugene.

Only A-1 contestants successfully defending titles were Johnson, Franklin of Portland, and Seal, Redmond. A total of 416 athletes competed in 520 matches during the two-day show with 2000 fans watching final bouts.

**TEAM SCORING: DIVISION A-1**—Sweet Home 79, Gresham 39, Grants Pass 34, Redmond 31, Klamath Falls 31, Roseburg 29, Franklin 27, Crater 27, David Douglas 25, Newberg 23, West Linn 23, Sandy 17, North Salem 15, Tillamook 15, Grant 14, Madison 13, Lebanon 12, Parkrose 11, Washington 11, Centennial 10, Hillsboro 9, Springfield 8, Oregon City 7, Prineville 7, North Eugene 6, Roosevelt 6, Bend 6, Sunset 3, Lincoln 3, Albany 2, South Eugene 2, South Salem 2, Corvallis 2, Clackamas 2, The Dalles 2, Dallas 1, Cleveland 1, Forest Grove 1, Medford 1, North Bend 1, Scappoose 1, Silverton 1. **DIVISION A-2 AND B**—Sutherlin 87, Eugene St. Francis 42, Sherwood 41, Estacada 40, Vale 38, Canby 34, Central 31, Philomath 31, Myrtle Point 28, Illinois Valley 27, Mapleton 24, Corbett 21, Gilde 19, Reedsport 18, Brookings 15, Knappa 14, Myrtle Creek 14, Newport 13, Henley 11, Yamhill-Carnton 11, Burns 10, Gold Beach 10, Pleasant Hill 6, Willamina 6, North Marion 4, Dayton 3, Lowell 3, Glendale 3, Harrisburg 3, Pacific 2.

### DIVISION A-1

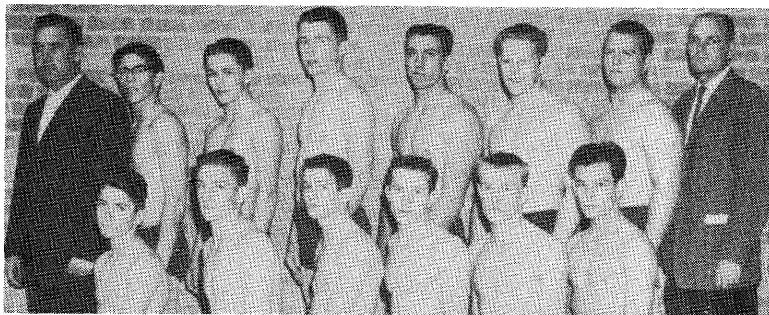
**98-LB—J. Lynn (SH) champion**, Crumrine (KF) 2nd, Russo (DD) 3rd, Karlick (OC) 4th; **106-LB—B. Lynn (SH)**, Eberhard (SH), Burgess (Pr), Smith (NE); **115-LB—Gasky (SH)**, Hashimoto (DD), Roley (GP), Lacombe (GP); **123-LB—Brown (Gra)**, Taylor (Ma), D. Payne (SH), Harris (SH); **130-LB—Johnson (Fr)**, Murphy (SH), Warren (Cr), M. Payne (SH); **136-LB—Moore (GR)**, Barrett (Ce), Mandelkow (Le), Ivory (Re); **141-LB—Hays (ND)**, Hawkins (Fr), Davidson (Re), Wishart (KF); **148-LB—Seal (Re)**, Ferguson (W), Wood (Ma), D. Lamp (Cr); **157-LB—A. Lamp (Cr)**, Politte (T), White (Ros), Wright (N); **168-LB—Keeney (WL)**, Mills (KF), Holliday (Pr), Franzen (DD); **178-LB—Dressell (N)**, Frisbie (Ros), Armitage (Gre), Moore (Roos); **191-LB—Birdwell (Gre)**, Winchester (Sa), John (Ros), McCreary (Sp); **HVYWT—Cole (GP)**, Erdman (Ma), Wartena (WL), Shores (GP).

### DIVISION A-2 AND B

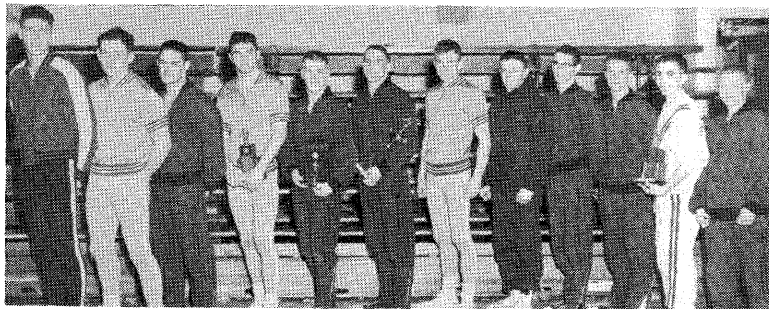
**98-LB—Moore (KN) champion**, Bailey (R) 2nd, Ayles (Co) 3rd, Hostetler (Ca) 4th; **106-LB—Stogsdill (Ce)**, Stevens (PH), Zufelt (Sh), Gravel (SF); **115-LB—Sinor (Br)**, Miller (Bu), Strong (Su), Brents (Ce); **123-LB—Kawamoto (Est)**, Marmolejo (IV), Cartisser (Co), Fagin (Su); **130-LB—Stewart (SF)**, Thomas (GB), Owings (Ca), Johnson (Ce); **136-LB—Heenan (Sh)**, Larson (Est), Carroll (Su), Funderbuck (Su); **141-LB—Williamson (V)**, Hilton (PH), Modrell (Su), Ludwig (Est); **148-LB—Rosenberg (IV)**, Kenagy (Ca), Londbrake (Su), Barnhart (M); **157-LB—Lowell (MC)**, Taylor (Ca), Williams (Y), Stitt (MP); **168-LB—Gilman (Su)**, Trask (PH), Hill (Gl), Walker (Ca); **178-LB—Edy (Sh)**, Edwards (Est), Manske (Gl), Linton (Su); **191-LB—Fulwyle (V)**, Parker (N), Barrick (Su), Wright (W); **HVYWT—Brodsky (SF)**, Manning (M), Long (He), Kinchloe (MP).



*IN SOUTH DAKOTA SPOTLIGHT-SPEARFISH: Left to right, front row—Ausmann, Matson, Coach Denker, Hughes (asst. coach), Gregson, Dittus, Hebert; back row—Linander, Buckholz, Christofferson, Riggs, Shepperson, Vance, Mattson, Shuck (mgr.).*



*SANDIA-NEW MEXICO CHAMPION IN TEAM'S SECOND SEASON: Left to right, front row—Davidson, Gilpin, Sabino, Wright, Burnett, Price; back row—Coach Lloyd, Martinez, Cloyes, Enright, Schropp, Byrd, Kerns, Coach Charlton.*



*MONTANA MONARCHS: Left to right—Ross (Bozeman), Habel (Great Falls), Nash (Missoula), Rowland (Great Falls), Golden (Missoula), Clark (Missoula), Pawbratz (Great Falls), Jones (Butte Central), Cates (Missoula), Stine (Missoula), Lockwood (Glasgow), Davis (Missoula).*

## Pennsylvania

By MARK H. FUNK, *PIAA Executive Director*

Approximately 300 member schools of the Pennsylvania Interscholastic Athletic Association participated in interscholastic wrestling during the school year 1959-60. Over 10,000 paid admissions to four regional contests and almost 10,000 saw the two sessions of the State Championship Meet held at Pennsylvania State University.

95-LB—Bob Bell (Columbia) champion; 103-LB—Terry Haise (Erie Strong Vincent); 112-LB—Mike Johnson (Lock Haven); 120-LB—Jerry Twoey (Phillipsburg-Oscola); 127-LB—Carl Fraley (Hughesville); 133-LB—Doug Koch (Bethlehem); 138-LB—George Reese (Trinity); 145-LB—John Carr (Hanover Twp.); 154-LB—Frank Eisenhower (Bald Eagle Nittany); 165-LB—Lee Hall (Hughesville); 180-LB—Marshall Dauberman (Selingsgrove); Unlimited—Jim Nance (Indiana).

## Rhode Island

By MANUEL GORRIARAN, *Secretary, R.I. Interscholastic Wrestling Assn.*

La Salle Academy's talented wrestling squad racked up a record-breaking 104 titles and took four individual titles as it captured the 20th annual Brown Interscholastics. La Salle's Dennis Kearney was awarded the Outstanding Wrestler's Trophy and did not have a point scored against him. Al Robillard won the Gorriaran Trophy for the fastest fall.

TEAM SCORING—La Salle Academy 104, Cranston 57, Warwick 47, Providence Country Day 36, Moses Brown 35, East Providence 28, Mount Pleasant 22, Hope 20, 115-LB—Pezza (C) champion, Sako (W) 2nd, Ramos (EP) 3rd; 121-LB—Chace (PCD), Riccitelli (LS), Hawcroft (W); 127-LB—Luz (LS), Cocroft (PCD), Maggiamaco (C); 133-LB—Pierannunzi (EP), La Butti (LS), McIntosh (C); 138-LB—Kearney (LS), Nixon (MB), Besette (C); 147-LB—Cerra (LS), Holmes (H), Jones (MB); 157-LB—Angell (W), Caobianco (LS), Leonard (C); 167-LB—Di Millio (MP), Robillard (C), Cerra (LS); 177-LB—Palmisciano (LS), Hazen (MB), Engles (PCD); HVYWT—Andrews (W), DiPalo (LS), Campagnone (MP).

## South Dakota

By ROGER W. DENKER, *Coach, Spearfish High School*

This, the third state meet, was held at Spearfish, with the host team winning the championships.

TEAM SCORING—Spearfish 112, Rapid City 97, Redfield 90, Sturgis 37, Huron 30, Miller 17, Mobridge 16, Lead 16, Aberdeen 2.

95-LB—Tinant (RC) champion, Wallman (Mi) 2nd, Cordas (St) 3rd, Matson (Sp) 4th; 103-LB—Mowry (RF), Richards (L), Gregson (Sp), Lundeen (RC); 112-LB—Cordell (RC), Ausmann (Sp), Stevens (RF), Yegar (M); 127-LB—Sherrill (H), Richardson (St), Word (RC), Hebert (Sp); 133-LB—Linander (Sp), Jennings (RF), Goodell (RC), Kutek (L); 138-LB—Buchhole (Sp), Wright (RF), Smith (Mo), Arth (H); 145-LB—Christofferson (Sp), Winkel (RC), Morey (RF), Lundgren (St); 154-LB—Neu (RF), Mattson (Sp), Teller (RC), Arends (St); 165-LB—Copp (RC), DeSart (Mo), Uance (Sp), Miller (RF); 175-LB—Riggs (Sp), Snyder (RC), Steele (RF), Anderson (St); HVYWT—Moery (RF), Anderson (H), Koers (RC), Shepperson (Sp).

## Utah

By HORACE H. ROSE

TEAM SCORING: "A" SCHOOLS—Olympus 60, Weber 50, Davis 44, Granite 33, Bountiful 31, Granger 27, West 24, Box Elder 18, Springville 15, Provo 14, Spanish Fork 14, Bingham 13, Orem 13, Ben Lomond 10, Carbon 10, Ogden 7, East 6, Bear River 5, Cyprus 4, Jordan 3, South Cache 3, Murray 0, Payson 0, South 0, Tooele 0, "B" SCHOOLS—Wasatch 87, Delta 62, Monticello 53, American Fork 39, Union 36, Millard 30, Pleasant Grove 22, East Carbon 20, North Sevier 14, San Juan 14, Cedar City 12, Uintah 9, Grand 9, Richfield 8, Lehi 8, Altamont 6, Dixie 4, Juab 2, South Summit 2, Hurricane 1, South Sevier 1, Wayne 1.

### CLASS A

98-LB—Olson (Ol) champion, Bryan (D) 2nd, Clark (Ca) 3rd, Cleverly (Bou) 4th; 106-LB—Bargar (D), McKee (Ol), Sanada (Wes), Brown (J); 115-LB—Corker (Gr),

Poll (D), Markos (Web), Nicholson (Cy); 123-LB—Evans (Bou), Lawrence (Web), Rowley (Or), Mathews (SC); 130-LB—Rock (Web), Seely (SP), Wright (Grg), Norman (BE); 136-LB—Flint (D), Ross (Grn), Teleford (Web), Harmon (SF); 141-LB—Naylor (Grn), Baker (Web), Rawlings (Or), Larson (Pr); 148-LB—Jensen (Ol), Leonard (Pr), Oswald (E), Saltas (Bi); 157-LB—Korous (Grn), Boyer (Spr), Sevy (Web), Evans (BR); 168-LB—Grant (Ol), Prawitt (Wes), Mackay (Grg), Rosenbaum (BE); 178-LB—Daughter (Ol), Marriott (BL), Bartholomew (Spr), Gunnarson (Og); HVYWT—Turpstra (Bou), Windchief (BE), Allen (Bi), Halliday (Grg).

#### CLASS B

98-LB—Hollien (AF) champion, Nielsen (Mo) 2nd, Huber (Was) 3rd, Marshall (Uni) 4th; 106-LB—Neff (SJ), Larsen (AF), Carlson (Was), Willoughby (De); 115-LB—Smith (Ce), Harding (Mld), Redd (Mo), Cesspooch (Uni); 123-LB—Pearson (Mo), Berg (Was), Lyman (De), Goodrich (Uni); 130-LB—Watson (Was), Callister (De), Moore (G), Smuin (Uni); 136-LB—McKee (Uni), Jeffery (De), Witt (Was), Rasmussen (L); 141-LB—Crittenden (Was), Sausedo (EC), Nielsen (De), Shaw (Mid); 148-LB—Lyman (De), Hone (Mid) Carlson (Was), Farnsworth (R); 157-LB—Runolfson (AF), Wescott (Mo), Reay (A), Huntsman (PG); 168-LB—Long (PG), Dudley (Uni), Monroe (Mid), Ekins (De); 178-LB—Patrick (Mo), Ainsworth (NS), McNaughton (Was), Long (PG); HVYWT—Averett (Was), Van Campen (EC), Talbot (De), Dimick (AF).

## Virginia

By **GEORGE McCLELLAND, Sports Writer, Virginian-Pilot**

Granby returned to the Virginia High School League wrestling throne room with six individual championships in the 12th annual State Meet. The Norfolk school, coached by Billy Martin, had won the first ten tournaments before losing to Washington-Lee of Arlington in 1959.

One of the six Granby titlists was Wayne Simons, unbeaten in 50 bouts and only the second Virginian to win four state titles.

Twenty-four schools entered 225 wrestlers in the tournament, held for the third straight year at Princess Anne High School.

**TEAM SCORING**—Granby 100, Princess Anne 76, Washington-Lee of Arlington 65, Warwick 46, Blacksburg 38, Wakefield 37, Norview 31, GW of Danville 20, Wilson 14, Mawry 12, Douglas Freeman 12, Virginia School for the Deaf 11, William Fleming of Roanoke 10, Great Bridge 9, Churchland 8, Fairfax 7, Dan Craddock 0, Lee of Staunton 0.

98-LB—Fletcher (War) champion, Wellstone (Wak) 2nd, Henderson (GWD) 3rd, Johnson (N) 4th; 106-LB—Seymour (W-L), Crowling (PA), Yeats (War), Harting (Wak); 115-LB—Raines (Bl), Boyd (PA), Kapryan (War), Clough (DF); 123-LB—Powell (G), Rowe (PA), Burgoon (W-L), Harris (Wi); 130-LB—Simons (Gr), Kirby (PA), West (Wak), Wilderman (W-L); 136-LB—Leffew (G), Glisson (N), Franken (War), Chapman (DF); 141-LB—Jordan (G), Hilliard (PA), Williams (Wi), Smith (War); 148-LB—Callahan (G), Boyd (PA), Knowing (Fl), Tedesco (G); 157-LB—Stone (Bl), Gantsoudes (GWD), Bregman (Wak), Hyman (W-L); 168-LB—Radford (G), Wood (PA), Dirks (Wak), Burnette (DR); 178-LB—Wulfsburg (W-L), Foster (G), Davis (Bl), Hargroves (C); HVYWT—Flesch (W-L), Whitley (N), Adkins (VSD), Hall (Fa).

## Washington

By **LEE NEWELL, Coach, Washington State University**

Moses Lake High School successfully defended its team title in the Eighth Annual State Wrestling Tournament. The state wrestling program experienced another year of expansion and should include more than a hundred schools this year. Moses Lake collected three individual championships, with the others shared by seven different schools.

**TEAM SCORING**—Moses Lake 68, Sedro-Woolley 52, Anacortes 43, Mt. Vernon 41, Hudson's Bay 32, Kennewick 27, Fife 22, Oak Harbor 22, Puyallup 18, Pasco 17, Othello 17, Kelso 15, Grandview 15, Yakima Eisenhower 11, Bethel 11, Olympia 11, Peshastin-Dryden 10, Battleground 8, Ephrata 8, Seattle Shoreline 8, Burlington 7, Tacoma Lincoln 6, Cheney 5, Mead 5, Naches 5, Mark Morris 5, Tacoma Wilson 4, Eastmont 4, Quincy 3, Pullman 2, Stadium 2, R.A. Long 2, Castle Rock 2, Wapato 2, West Bremerton 2, Renton 2, Richland 2, Walla Walla 1, Bothell 1, Edmonds 1, Auburn 1, Clover Park 1, Davis 1, Wenatchee 1.

106-LB—Yamada (F) champion, Hartley (K) 2nd, Ross (P) 3rd, Clement (N) 4th; 115-LB—Johnson (HB), Merkeley (ML), Zaack (Be), Smith (MV); 123-LB—Frederick-

son (ML), Cotton (A), Schaller (HB), Fox (F); 130-LB—Warren (O), Wooding (A), Hashbarger (E), Neal (MV); 136-LB—Wolfe (ML), Thompson (HB), Masonholder (MV), Adams (SW); 141-LB—Sullivan (A), Sandifer (SW), Minitani (ML), Chestnut (SW); 148-LB—Merkley (ML), Sullivan (MV), Beebe (BG), Hatten (A); 157-LB—Nicolet (P), Bartek (SW), Edwards (ML), Vandelinder (BE); 168-LB—Brown (SW), Burvee (PD), Schultz (P), Birbech (MM); 178-LB—Schlattelt (G), Lang (OH), Dykes (YE), Dougal (TL); 194-LB—Barclay (SW), Meier (K), Fagan (MV), Fossett (SL); HVYWT—McCoy (K), Nienhius (OH), Morgan (O), Slostad (MV).

## West Virginia

By **STEVE HARRICK**, *University of West Virginia*

Fairmont West High won its first State High School Wrestling Tournament Championship by edging Barboursville High 38-37 at West Virginia University. Parkersburg High, winner of the past three crowns, was third with 33 points. Fourteen schools from four regions qualified forty wrestlers.

**TEAM SCORING**—Fairmont West 38, Barboursville 37, Parkersburg 33, Beckley 24, Sophia 24, Weirton 22, Hinton 20, Kingwood 15, Harrisville 12, Kingwood 19, Morgantown 9, Mullens 9, Logan 8, Dupont 2.

**103-LB**—Thompson (Be) champion, Dickel (P) 2nd, Carter (Ba) 3rd. Slavens (M) 4th; **112-LB**—Crane (H), Kiser (S), J. Burnett (F), Mancari (D); **120-LB**—T. Burnett (F), Neff (Ba), Ritchie (W), Long (Be); **127-LB**—Jolley (S), Clay (Ba), Billecheck (W), Gray (F); **133-LB**—Stoops (P), Waid (H), Feathers (M), Reed (Ba); **138-LB**—Mills (S), Julian (F), Curiman (P), Lane (Ba); **145-LB**—McBride (H), Walker (L), Holman (P), Luchini (M); **154-LB**—Staud (F), Atwood (Mu), Childers (W), Swanson (Ba); **165-LB**—Walls (Be), Burns (W), Forman (K), Smith (Ba); HVYWT—Hardesty (K), Mullens (Ba), Anderson (P), Palmer (SS).

## Wisconsin

By **GORGE MARTIN**, *Coach, University of Wisconsin*

1960 saw interscholastic wrestling in Wisconsin reach new highs in number of schools participating and in caliber of competition. Approximately 125 schools sponsored the sport with 112 entering teams in the state tournament series, which this year added regional eliminations to the sectional contests formerly held in qualifying for the state tournament. Sixty-two schools qualified one or more boys for the state meet which was held in the University Field House in Madison. Coach Jim Douglas' fine team from Coleman High, runners-up in 1959, dominated the field to take the team title.

**TEAM SCORING**—Coleman 53, Amery 37, Stoughton 34, Tomah 25, Madison West 23, Schofield 23, Beloit 22, Manitowoc 22, Reedsburg 20, Wisconsin Rapids 18, Wittenberg 18, Granville 14, Brillion 13, Fort Atkinson 13, Kenosha 13, Milwaukee Custer 13, Madison East 11, Milwaukee Washington 11, Oconomowoc 11, Menomonee 10, Milwaukee Pulaski 10, Sevastopol 9, Waupun 9, West Allis Nathan Hale 9, Milwaukee South 8, Milwaukee Rufus King 7, Rice Lake 7, West Milwaukee 7, Jefferson 5, Beaver Dam 4, Greenfield 4, Janesville 4, West Allis Central 4, Muskego 3, Berlin 2, Brookfield 2, Milwaukee North 2, Sparta 2, Wisconsin Dells 2, Eau Claire 1, Greendale 1, Milwaukee Lincoln 1, Stevens Point 1, Sturgeon Bay 1.

**103-LB**—Mitchell (MC) champion, Bach (ME) 2nd, Warhol (A) 3rd, Johnson (RL) 4th; **112-LB**—Hack (St), Champagne (A), Bessette (Wi), Bellinghausen (MRK); **120-LB**—Berg (WR), Lesperance (C), Struzik (MP), Olsen (T); **127-LB**—Bolden (Bel), Fust (Sc), Verkuilen (Wi), Posada (MS); **133-LB**—Karpinski (A), Smith (K), Sackerson (WM), Vondross (C); **138-LB**—Goeters (Man), Foss (R), Roberts (A), Pierce (T); **145-LB**—Pharo (T), Ahrens (FA), Welbourne (WANH), Marks (O); **154-LB**—Krueger (Bri), Rousseau (St), Langlois (Ma), Fowler (A); **165-LB**—Smith (MaW), Patz (C), Olson (Me), Wersland (St); **180-LB**—Waltz (Gra), Dittbender (Sc), Melaas (Bel), Wegner (O); HVYWT—Pillath (C), McCoy (MiW), Tanck (Se), Richter (Wa).

## Wyoming

By **DALE FEDERER**, *Laramie*

Dave Edington of Saratoga, the first wrestler in Wyoming to win four state championships, was elected the outstanding wrestler by the coaches. The quick-fall trophy was won by Lucas of Laramie.

**TEAM SCORING**—Powell 59, Laramie 50, Rock Springs 43, Worland 42, Wheatland 41, Casper 38, Saratoga 31, Evanston 19, Lander 17, Lusk 13, Riverton 13, Cheyenne 11, Gillette 9, Thermopolis 9, Torrington 6, Newcastle 4, Cody 0, Greybull 0, Lovell 0, Mountain View 0, Sheridan 0.

95-LB—Zanetti (RS) champion, Gordon (Wo) 2nd, Lucas (Lar) 3rd, Valdez (R) 4th; 103-LB—Rollings (RS), Brinkerhoff (Wo), Maki (Sa), Sanchez (Ch); 112-LB—Hernandez (Wo), Sargent (RS), Johnson (Wh), McKinney (To); 120-LB—Bowen (Wh), Darnell (Ri), Fuller (Lan), Busch (Ca); 127-LB—Caturia (P), Scott (Lar), Moon (RS), Regan (Lan); 133-LB—Mogenson (Lar), Darling (Ca), Wilson (Lan), Griggs (E); 138-LB—Edington (Sa), Caraveo (P), Boyles (Wo), Brening (Ch); 145-LB—Frude (La), Hockett (Ca), Frazier (Ca), Frazier (P), Nelson (Th); 154-LB—Argento (P), Swanson (Sa), Allison (Ca), Munroe (N); 165-LB—Kinney (Lu), Gladson (Gi), Hoffman (P), Shelly (Th); 175-LB—Lowham (E), Terry (P), Ringinger (Lar), Smith (Wh); HVYWT—Ginn (Wh), Gray (Ca), Wiley (P), Shearer (Wo).

## Academy School Tournament

By **FREDERICK R. KUHN, Coach, Mercersburg Academy**

The 25th Annual Lehigh Prep School Tournament, entertained sixteen schools and 112 entries. A crowd of over 2,000 rooters saw five of Bryn Athyn's six finalists win championships to dethrone Hill school by 18 points. John Gladish of Bryn Athyn, with 2 falls and 2 decisions, was voted outstanding wrestler. Heavy snows kept several schools from competing.

**TEAM SCORING**—Bryn Athyn 89, Hill 71, Milton Hershey 70, St. Paul's 31, Wyoming Sem. 28, Kiski 26, Albany 15, Baylor 11, Valley Forge 10, Friends 6, Horace Mann 6, N. Y. Military 5, Manlius 4, Hackley 4, Perkiomen 1, Montclair 0.

106-LB—Haydn (BA) champion, Gabel (H) 2nd, Hillman (HM) 3rd, Phillips (MH) 4th; 115-LB—Rhodes (MH), Smith (Ba), Becker (H), Lister (SP); 123-LB—Rose (BA), J. Ferrick (K), Menser (MH), Herasimchuk (H); 130-LB—Yeager (WS), Klein (A), Thompson (MH), Joseponis (SP); 136-LB—Via (MH), McAlpin (H), Belyae (NYMA), Anfanger (Hck); 141-LB—Klippenstein (BA), Shelly (MH), Wick (H), Fuelhart (K); 148-LB—Vogt (WS), Stowell (H), Boehm (B), Jones (F); 157-LB—Mergen (BA), Mautser (VF), Schaff (H), VanCleave (B); 168-LB—Gladish (BA), Morton (H), Hunt (MH), Ladd (SP); HVYWT—Lutz (SP), Clore (MH), Doering (BA), Patterson (K).

## Episcopal Invitation Tournament

By **NEIL BUCKLEY, Coach, The Haverford School**

Haverford School won its ninth Episcopal Academy Invitation Tournament, held annually at the University of Pennsylvania Palestra. The finals of the 13th annual tournament were witnessed by two thousand spectators. A total of 127 wrestlers from eleven private schools in the Philadelphia area participated in the three day tournament. Haverford's Captain, Phil Burnham, was chosen outstanding wrestler.

**TEAM SCORING**—Haverford School 88, Penn Charter 79, Girard College 65, Episcopal Academy 29, Perkiomen School 23, Germantown Friends 20, Malvern Prep 18, Germantown Academy 10, Friends Central 8, Valley Forge Military 2, Friends Select 0.

95-LB—Jones (PC) champion, Buchman (G) 2nd, Oehrle (H) 3rd, Ryan (M) 4th; 103-LB—Palmer (P), Eddleman (PC), Nance (H), Braun (G); 112-LB—Stuart (PC), Wilson (E), Wiegand (GF), T. Hallam (G); 120-LB—Buell (H), Frazier (PC), J. Hallam (G), Price (FC); 127-LB—Parlett (M), Jacobs (H), DiOrio (G), Holmes (PC); 133-LB—Steger (P), Surbeck (E), McDowell (PC), Deveny (G); 138-LB—Scott (H), Fricke (E), Judson (FC), Dougherty (G); 145-LB—Burnham (H), Myers (G), Clark (GF), Knauer (E); 154-LB—Bentz (H), Schnabel (PC), DiTizio (G), Noy (VFM); 165-LB—Maine (GF), Adams (G), Clarke (H), Crosby (PC); 180-LB—Dallas (GA), Swenson (PC), Hunt (H), Croasdale (E); HVYWT—Cromwell (H), Prickett (PC), Smith (G), O'Neill (M).

## North Central Association of Schools for the Blind

By **SY HALICZER, Illinois Braille and Sight Saving School**

The Michigan School for the Blind dethroned the Missouri Mules in taking their first conference championship. Coach Fran Hetherington's Michigan squad had ten boys place among the top three finishers in their divisions for a well balanced team victory.



This year's tournament was the biggest ever as it included eleven teams and a total of 97 contestants. Six teams produced champions.

**TEAM SCORING**—Michigan School for the Blind 120, Missouri School for the Blind 101, Indiana School for the Blind 45, Iowa Braille and Sight Saving School 36, Illinois Braille and Sight Saving School 30, Kentucky School for the Blind 25, Minnesota Braille and Sight Saving School 24, Kansas School for the Blind 20, Nebraska School for the Blind 10, Wisconsin School for the Visually Handicapped 3, South Dakota School for the Blind 2.

**95-LB**—Frees (Mich) champion, Lewis (Mo) 2nd, Saeugling (Ia) 3rd, Brown (Kan) 4th; **103-LB**—Randall (Kan), Milliman (Mich), Dasher (Neb), Lane (Mo); **112-LB**—Phipps (Ill), Sykora (Mich), Oster (Mo), Dickerson (Ky); **120-LB**—Piel (Mo), Harris (Mich), McNeeley (Ind), Newman (Ia); **127-LB**—Filter (Mich), Ney (Mo), Washington (Ky), Clark (Ind); **133-LB**—Sykes (Mo), Gleason (Mich), Carnes (Ky), Sleighton (Ia); **138-LB**—Ruttan (Mich), Warren (Ind), Cook (Mo), Donaldson (Ill); **145-LB**—Adams (Mo), Blumenthal (Minn), Nachtrieb (Mich), Carver (Ky); **154-LB**—Caffery (Mich), Barton (Ill), Million (Minn), Enfield (Ind); **165-LB**—Levy (Ind), Vinson (Mo), Picha (Minn), Paul (Ia); **HVYWT**—Jones (Ia), Gunnerson (Mo), Whittaker (Mich), Kumbalek (Wis).

## Ivy Prep School Tournament

By ALVIN D. MILLER, Sr. Paul's School, Chairman

**TEAM SCORING**—Saint Pauls 54, Stony Brook 47, Riverdale 43, Poly Prep 28, Horace Mann 24, Trinity 9, Hackley 8.

**106-LB**—Levine (R) champion, Hillman (HM) 2nd, Kuo (SB) 3rd, Vogelson (T) 4th; **115-LB**—Rocherolle (R), Lister (SP), Wan (SB) Golden (T); **123-LB**—Whittaker (SP), Rizzuti (P), Trochez (R), Phillips (SB); **130-LB**—Ramos (HM), Lane (SP), Wright (R), Kahani (SB); **136-LB**—Anfauger (H), McTaggart (T), Woods (SB), Joseponis (SP); **141-LB**—Spear (SB), Wurmfield (HM), Westney (R), Stetson (SP); **148-LB**—Duffy (SB), Kaufman (P), Haynes (SP), Sachs (HM); **156-LB**—Nocito (SP), Soloman (P), Kleinzahler (HM), Davidenko (SB); **168-LB**—Glazier (R), Hamway (P), Pierce (SB), Raff (HM); **178-LB**—Ladd (SP), Richard (R), Daiker (SB), Kritzalis (T); **HVYWT**—Lutz (SP), Borggren (P), McLean (SB), Gardner (H).

## SHOZO SASAHARA presents

- Onizuka nylon wrestling shoes  
light — flexible — durable — tops in traction —  
inverted eyelets — blue or white ..... **\$5.25**
- International wrestling uniform ..... **\$7.50**
- Leg tights ..... **\$7.50**
- Trunks ..... **\$5.00**
- Wrestling shirts  
All colors — with or without leg stripes —  
nylon or wooly nylon
- Sasahara Film (made in Japan)  
1200 ft. in 16mm Training Methods and Techniques ..... **\$80.00**  
or rental
- Sasahara Wrestling Book
- Other athletic products

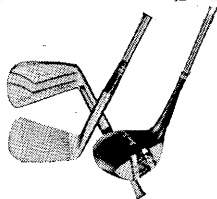
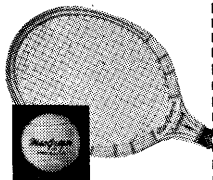
All items F.O.B. New York City

## SHOZO SASAHARA

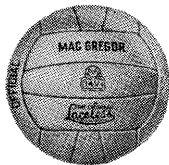
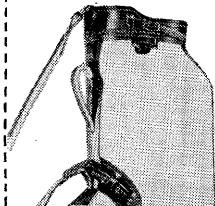
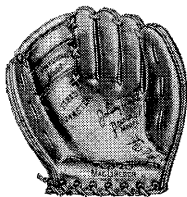
347 Beach 147th Street, Neponsit 94, Queens, N. Y.



*"Wherever you see good sports, you see MacGregor"*



*MacGregor*<sup>®</sup>



*Look to MacGregor first for the finest in all sports equipment.*

**The MacGregor Co. • Cincinnati 32, Ohio**

**FOOTBALL • BASEBALL • BASKETBALL • GOLF • TENNIS**

OFFICIAL WRESTLING GUIDE

# OFFICIAL

Intercollegiate and Interscholastic

# WRESTLING RULES

## NCAA Wrestling Rules Committee

CHARLES W. PARKER, <i>Chairman</i> .....	Davidson
RALPH G. ANDERTON .....	Brown
JOSEPH W. BEGALA .....	Kent State
JOHN W. HANCOCK .....	Colorado State College
FRITZ K. KNORR .....	Kansas State
CLAUDE C. REECK .....	Purdue
WILLIAM A. TOMARAS .....	California
RICHARD L. VOLIVA .....	Rutgers
FINN B. ERIKSEN .....	Waterloo Public Schools, Ia.
JOHN E. ROBERTS .....	Wisconsin Interscholastic AA

RAYMOND E. SPARKS, EDITOR

# Index to Rules

	<i>Rule</i>	<i>Sec.</i>	<i>Page</i>		<i>Rule</i>	<i>Sec.</i>	<i>Page</i>
Abusive Conduct .....	10	5	71	Out-of-Bounds .....	8	5	66
Advantage, Position of ...	8	3	66	Overtimes .....	7	4	64
Byes .....	6	4	60	Recording .....	9	2	69
Compete in One Class Only	2	2	56	Penalties .....	11	..	77
Control .....	8	2	65	Off Mat to Prevent Fall	10	7g	75
Costumes .....	3	2	57	Off Mat Intentionally	10	7f	75
Decisions .....	8	14	68	Forcing Opponent Off			
Matches .....	8	14	68	Mat .....	10	7e	75
Defaults .....	8	16	68	Stalling .....	10	7h	75
Definitions .....	8	..	65	Penalty Chart .....	..	..	78
Distinguishing Emblems ..	3	2d	57	Point System .....	9	2	69
Drawings and Elimination ..	6	..	60	Position of Advantage ..	8	3	66
For Third Place .....	6	6	63	Potentially Dangerous			
Graphic Illustration of ..	6	5	61	Holds .....	10	6	71
Seeding .....	6	3	60	Holds Over Mouth, Nose,			
Eligibility .....	1	..	56	Eyes, or Throat .....	10	6a	73
Escape .....	8	9	67	Predicament .....	8	13	67
Fall .....	8	11	67	Referee			
With Part of Body off				Costume .....	..	..	89
Mat .....	8	11a,b	67	Duties .....	13	1	80
Foreign Substance on Skin	10	3	70	Signals .....	..	..	89
Forfeit .....	8	15	68	Referee's Position on Mat	8	1	65
Holds—Illegal .....	10	1	69	Representation .....	2	..	56
Bending of Fingers .....	10	1	69	Reversal .....	8	10	67
Body Slams .....	10	1	69	Roughness-Unnecessary ..	10	2	70
Double Wristlock .....	H.S.	5	86	Butting .....	10	2	70
Full Double Nelson .....	10	1	69	Elbowing .....	10	2	70
Hammerlock Above Right				Gouging .....	19	2	70
Angle .....	10	1	69	Hair-Pulling .....	10	2	70
Over-Scissors .....	10	1	69	Kicking .....	10	2	70
Strangle Holds .....	10	1	69	Strangling .....	10	2	70
Twisting of Fingers .....	10	1	69	Striking .....	10	2	70
Toe Holds .....	10	1	69	Seeding .....	6	3	70
Infractions .....	10	..	69	Scoring .....	9	..	60
Injuries .....	12	1	79	Tournaments .....	9	1b	68
Accidental .....	12	2	80	Dual Meets .....	9	1a	68
From Illegal Hold .....	12	3	80	Point System .....	9	2	68
Intermissions .....	7	2	64	Spectators' Behavior ..	13	16	84
Interscholastic .....	..	..	85	Stalemate .....	8	7	84
Matches—Length of .....	7	1	63	Stalling .....	10	7h	67
For First Place .....	7	1	63	Take Down .....	8	4	75
For Third Place in Tour-				Technical Violations			
naments .....	7	5	65	Delaying Match .....	10	7d	73
Intermissions between				Grasping Clothing .....	10	7i	75
periods .....	7	2	64	Holding Legs .....	10	7b	75
Intermissions between				Intentional going off			
overtimes .....	7	4	64	the mat .....	10	7f	75
Mats .....	3	1	56	Interlocking of Arms ..	10	7a	73
Near Falls .....	8	12	67	Interlocking of Fingers	10	7a	73
Neutral Position .....	8	8	67	Interlocking Hands .....	10	7a	73
Notification and Agree-				Leaving Mat .....	10	7c	73
ments .....	14	..	84	Stalling .....	10	7h	75
Objectionable Pads .....	10	4	71	Time Advantage .....	8	2	65
Enforcement .....	3	5	58	Time out .....	..	..	..
Special Equipment .....	3	4	58	Unnecessary Roughness ..	10	2	70
Officials .....	13	..	80	Weighing-In .....	5	1	58
Referee .....	13	1	80	Weight Classification ..	4	1	58
Timekeepers .....	13	3	80	Weight Control .....	H.S.	2	85
Overtimes .....	7	4	64	Weight Allowance .....	5	2	59
				Failure to Make .....	5	3	59

# Major Rules Changes

Rule 3, Sec. 2a. Statements are added to clarify a legal costume: Full length tights and close covering sleeveless shirts are recommended. The one piece uniform is illegal for interscholastic and NCAA competition.

Pictures Nos. 1 and 2. A sentence is added which states that: Any shirt with more exposure is illegal.

Picture No. 3. Has been replaced by a picture in which the contestants are wearing legal costumes.

Rule 5, Sec. 7. A new section states: A forfeit or disqualification will eliminate a contestant from third place competition in tournaments. (This is clarified in the penalty chart.)

Rule 7, Sec. 1. A last sentence is added which states: The time in a match is continuous except when the referee stops and starts a match.

Rule 8, Sec. 6. The last phrase in the first sentence has been deleted. It read: except when a penalty involves a change of position. The word "standing" in the second sentence has been deleted.

Rule 8, Sec. 16. The last part of the sentence has been deleted. It read: a disqualification or for some other causes.

Rule 10, Sec. 6. The last phrase in the last sentence of the second paragraph has been deleted. It read: unless a penalty involves a change of position.

Penalty Chart. An asterisk has been placed beside "Technical Violations" and refers to two notes: (1) A verbal warning shall precede the first penalty for a technical violation which involves stalling. (2) Disqualification due to a technical violation, illegal holds, or less flagrant unnecessary roughness, does not eliminate a contestant from competition for third place. . . . Disqualification for any other reason eliminates a contestant from competition for third place. . . .

Rule 12, Sec. 1. Any excessive bleeding as well as nose bleed shall not be interpreted as an injury in the time-out rule. The number and length of the time-out periods are left to the discretion of the referee.

Rule 12, Sec. 2. At the end of the last sentence the word "fall" has been replaced by the words "default due to injury."

Rule 13, Sec. 2C. The words "to the edge of" have been replaced by the word "on."

## INTERSCHOLASTIC MODIFICATIONS

Item 5C and Pictures Nos. 28 and 29. The statements now include "the neck" as well as the head in regard to locking or overlapping the hands around opponents head or neck in the Guillotine.

## REFEREES' SIGNALS

Fig. 12. The third sentence has been deleted. It stated that the referee may indicate the extent of the situation by holding one hand behind his back with the fingers extended to indicate the points that will be awarded when the pinning situation is over.

# Official NCAA Wrestling Rules

## RULE I—ELIGIBILITY

SECTION 1. Each contestant must be an Amateur as defined in the rules of the National Collegiate Athletic Association and be eligible according to the rules and regulations of the college or university which he represents. Participants in the National Collegiate Wrestling Championships must represent institutions which are active members of the NCAA in good standing and must conform to the rules of eligibility adopted by the NCAA to apply to all annual championship meets conducted by this Association.

Note—See Rule 5, Section 4.

SECTION 2. All colleges, universities and institutions of learning in the United States with acceptable scholastic and athletic standards may be elected to membership in the NCAA. To comply with "acceptable scholastic standards" the institution must be on the approved list of the accepted accrediting agency of the district in which the institution is located.

SECTION 3. An institution is considered as having "satisfactory athletic standards" on approval of its standards by a two-thirds majority of the active members of the NCAA in the Association District in which the institution is located. Further information regarding application for membership may be obtained from the Executive Director of the NCAA, Walter Byers, 209 Fairfax Building, Kansas City 5, Mo. At least thirty (30) days should be allowed for the above procedure.

## RULE II—REPRESENTATION

SECTION 1. An institution shall be represented by only one contestant in each weight class.

SECTION 2. No contestant shall be allowed to represent his institution in more than one class in each meet.

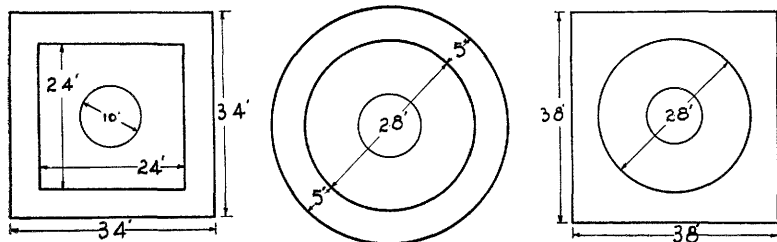
SECTION 3. A representative may not accept a forfeit in one weight class and compete in another class.

SECTION 4. A contestant who weighs-in for one weight class may be shifted to a higher weight class.

**National Collegiate Championships** SECTION 5. All entries to the National Collegiate Wrestling Championships which are received after the deadline date shall be charged a double entry fee. The deadline shall be nine days in advance of the first tournament session. When the team registers at the National Championships the institutional representative shall indicate the entry in each weight class in so far as it is possible before the weighing-in.

## RULE III—MATS, COSTUMES AND EQUIPMENT

**Mats** SECTION 1. The wrestling area of the mat shall not be less than a square 24 feet by 24 feet. There shall be a mat area at least 5



MINIMUM MAT SIZES

*A circle with a diameter of 28 feet is a legal wrestling area providing there is a mat area at least 5 feet in width which extends around it.*

feet in width which extends entirely around the wrestling area. The entire mat area shall be the same thickness which shall not be more than 4 inches nor less than the thickness of a mat which has the shock absorbing qualities of a 2-inch thick hair felt mat.

It is recommended that a moleskin, canton flannel, rubber, or plastic mat cover be provided sufficiently large to cover the mat proper and all supplementary mats. This cover should be stretched tightly and be held in place by ropes, or tape fastening the mat cover to the under side of the supplementary mats, or by lacing the cover underneath the mats. The wrestling area should be marked on the mat cover by painted lines two inches in width. At the center of the mat proper there shall be similarly painted a circle ten feet in diameter. Whenever the match is started or resumed, the contestants shall be opposite each other on the 10-foot circle and throughout the match contestants are expected to wrestle within this circle so far as possible. There shall be placed at the center of the cover a design, at least twelve inches long, perpendicular to and pointing away from the timer's table. This design designates the place where matches are to start and the direction wrestlers are to face when starting the wrestling from the referee's position on the mat.

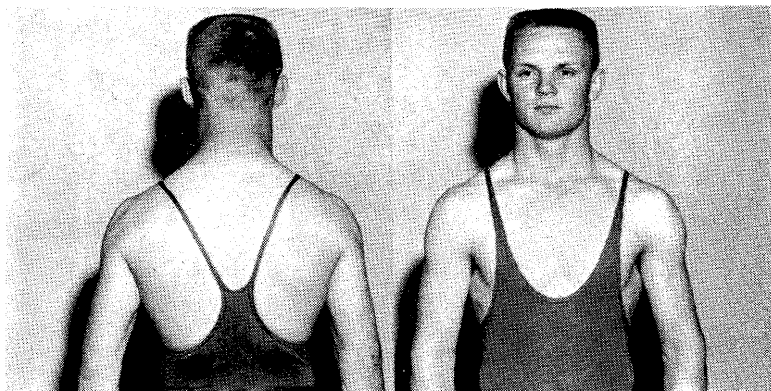
**Costume****SECTION 2. The costume shall consist of:**

a. Full length tights and close fitting outside short trunks. Trunks may be worn without the tights if they are fitted so as to prevent unseemly exposure, however, full length tights and close covering sleeveless shirts are recommended. When trunks are worn without tights, shirts shall be required. The one piece uniform is illegal for interscholastic and NCAA competition.

b. Light heelless gymnasium shoes reaching above the ankle and laced by means of eyelets.

c. Shirts, if required by the home management. The shirt shall be sleeveless without fasteners at the shoulder and fastened down at the crotch. They shall not be cut away in excess of the shirt illustrated in Figures 1 and 2 (picture of legal shirt, back and front view). The visiting team must be notified in sufficient time to be able to comply with the home team's request. (See Rule 14, Section 3.)

d. It happens occasionally that two contestants look so much alike and are dressed so similarly that it is very difficult for the Referee and spectators to distinguish them. In all dual meets or tournaments, the home management shall have immediately available some provisions for clearly identifying the



Nos. 1 and 2—FRONT AND REAR VIEW OF SHIRT

*This shows the front and rear view of the official shirt. Any shirt with more exposure is illegal.*

**contestants.** Such provisions may be by means of colored anklets, numbers or any other plan which will accomplish the purpose.

**Headgears** SECTION 3. The Wrestling Rules Committee strongly recommends that protective headgear be used in all practice and competition.

**Special Equipment** SECTION 4. Any mechanical device which does not allow normal movement of the joints and prevents one's opponent from applying normal holds shall be barred. Any legal device which is hard and abrasive must be covered and padded. Loose pads are prohibited.

**Enforcement** SECTION 5. The legality of all equipment (mats, costumes, helmets, devices, pads, etc.) shall be decided by the referee.

## RULE IV—WEIGHT CLASSIFICATIONS

SECTION 1. Competition shall be divided into eight weight classes as follows:

123 lbs.	137 lbs.	157 lbs.	177 lbs.
130 lbs.	147 lbs.	167 lbs.	Unlimited

The 115-lb. and/or 191-lb. classes may be officially included in the weight classification provided either or both are adopted by individual conferences. Interference meets shall be contested in the original (8) weights.

For the National Collegiate Wrestling Championships the 115 and 191-lb. classes will be included. These weights will count in the scoring of the team championship.

## RULE V—WEIGHING-IN AND DESIGNATION OF CONTESTANTS

**Time** SECTION 1. *a. Tournaments.* Each day of the tournament, except the first day, contestants will weigh-in a maximum of five hours



and a minimum of four hours before the meet is scheduled to begin.

For the first day of the National Collegiate Wrestling Championships contestants will weigh-in a maximum of six hours and a minimum of five hours before the meet is scheduled to begin

b. The contestant who is to represent his institution must be named before the drawings are made.

c. *Dual Meets.* Contestants may weigh-in a maximum of five hours and a minimum of one-half hour before the meet is scheduled to begin. The exact maximum time shall be decided by mutual agreement of the competing teams. The home team's representative shall be sent onto the mat first, and he cannot be withdrawn or replaced.

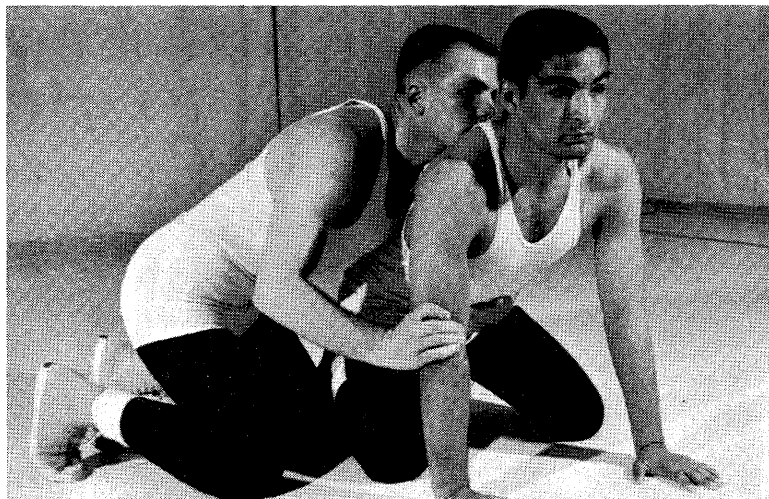
d. *Supervision.* The Referee or other authorized person shall supervise the weighing-in of contestants.

e. Teams may weigh-in on home scales by mutual agreement of coaches and shall furnish the weight list with actual weights listed.

**Weight Allowance** SECTION 2. *a. Dual Meets.* In all dual meets, net weights shall be required. No overweight is permitted nor should it be requested.

b. *Tournaments.* In tournaments a one pound allowance shall be given each day over the weight limit of the previous day.

**Failure to Make Weight** SECTION 3. Any contestant failing to make weight at the minimum time shall be rejected. If a contestant fails



No. 3—LEGAL "REFEREE'S POSITION ON MAT"

This position is shown as required in Rule 8, Section 1, a and b. Note particularly that offensive wrestler's leg is outside of defensive wrestler's leg.

to weigh-in on the second or subsequent day a forfeit shall be awarded his opponent and points for the forfeit and advancement shall be scored.

**Medical Examinations** SECTION 4. At the time of the weighing-in on the opening day of the annual National Collegiate Championships, a physician or physicians shall be present to examine all contestants for communicable diseases and shall disqualify any contestant who, in their judgment, will endanger other participants. In other meets it is recommended that a medical examination of all contestants be made at the time of the weighing-in, and the presence of a communicable disease or any other condition, which in the opinion of the examining physician makes the participation of that individual inadvisable, should be considered full and sufficient reason for disqualification.

SECTION 5. No substitution is allowed in dual meets or tournaments for injured contestants.

SECTION 6. Defeat due to injury in a tournament does not eliminate a man for third place competition.

SECTION 7. A forfeit or disqualification will eliminate a contestant from third place competition in tournaments. (See note under penalty chart.)

## RULE VI—CONDUCT OF TOURNAMENTS

**Places Scored** SECTION 1. In all tournaments four places shall be awarded as follows: The loser in the final first place match shall automatically take second place; the winner of the final consolation match shall be awarded third place and the loser fourth place.

**Drawings** SECTION 2. Immediately after the expiration of the minimum weighing-in time, drawings shall be made. Drawings shall be made in accordance with the graphic illustrations as provided in Sections 5, 6 and 7 of this rule.

**Seeding** SECTION 3. Whenever there are two outstanding contestants in any class, the name of one of these contestants shall be placed in the upper half of the drawing bracket and the name of the other in the lower half. In case several seeded men are of equal ability, their seeded positions shall be determined by drawing.

If there is one outstanding wrestler in any class and also two others who are distinctly superior to the remainder in that class, those wrestlers should be seeded in different quarter brackets of the opposite half bracket from the outstanding wrestler. A seeded contestant shall have the same opportunity to draw for the bye as other contestants in his bracket.

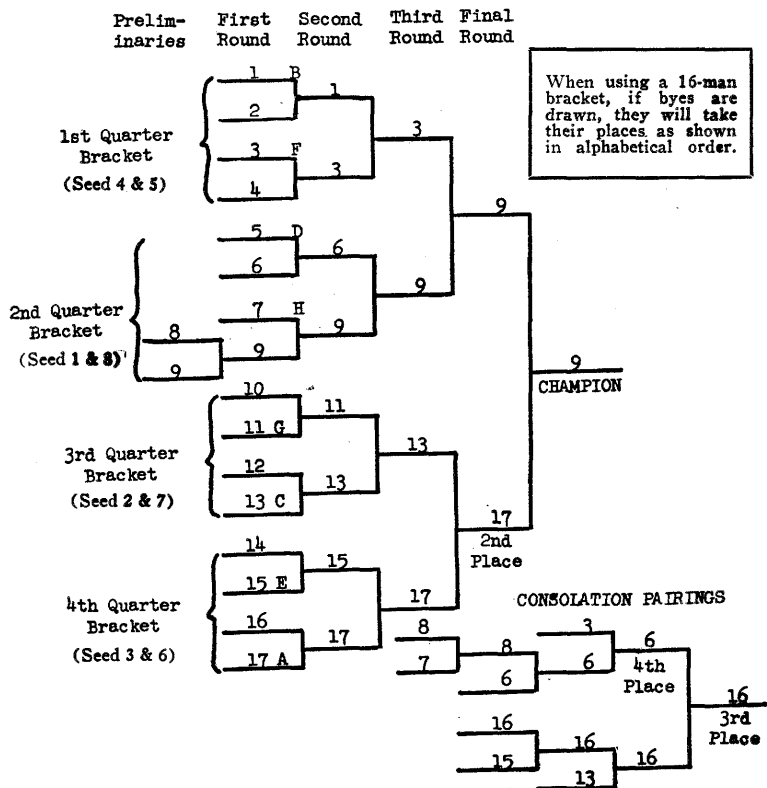
In the annual National Collegiate Championships, whenever possible, contestants from the same geographical location or conference who have previously met during the season shall be drawn so as to prevent them from meeting in the first round.

**Byes** SECTION 4. When the number of competitors is not a power of two (that is, 4, 8, 16, 32, 64) there shall be "byes" in the first round. The number of pairs which meet in the first round shall be equal to the difference between the number of competitors and the next lower power of two. There will be no byes after the first round and no further drawing is necessary for the first place or consolation rounds. The byes, if even

in number, shall be equally divided between top and bottom. If the number of byes be uneven, there shall be one more bye at the bottom than at the top, as shown in Section 5 of this rule.

Any conference or other tournament may be conducted under any bracketing that is agreed upon by the participating schools.

**SECTION 5. Graphic Illustration of Drawings and Seeding.**



Number 1 seeded man draws for possible positions 5, 6, 7, 8, 9, in 2nd Quarter Bracket.

Number 2 seeded man draws for possible positions 10, 11, 12, 13, in 3rd Quarter Bracket.

Number 3 seeded man draws for possible positions 14, 15, 16, 17, in 4th Quarter Bracket.

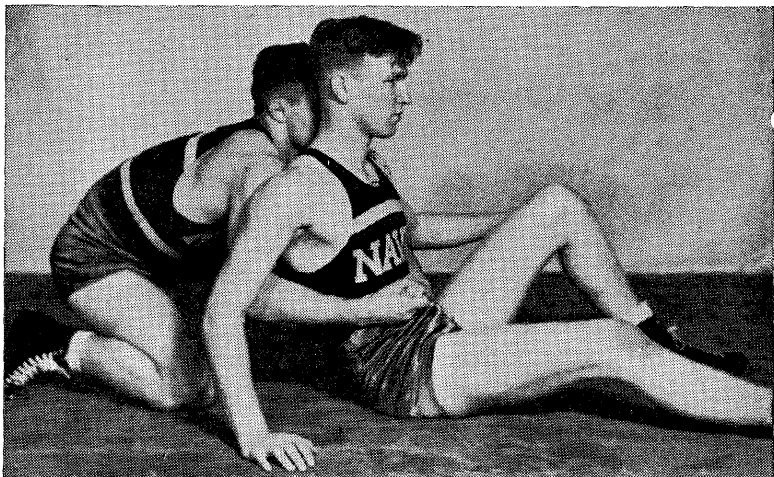
Number 4 seeded man draws for possible positions 1, 2, 3, 4, in 1st Quarter Bracket.

Number 5 seeded man draws for position in opposite half of Quarter Bracket #1.

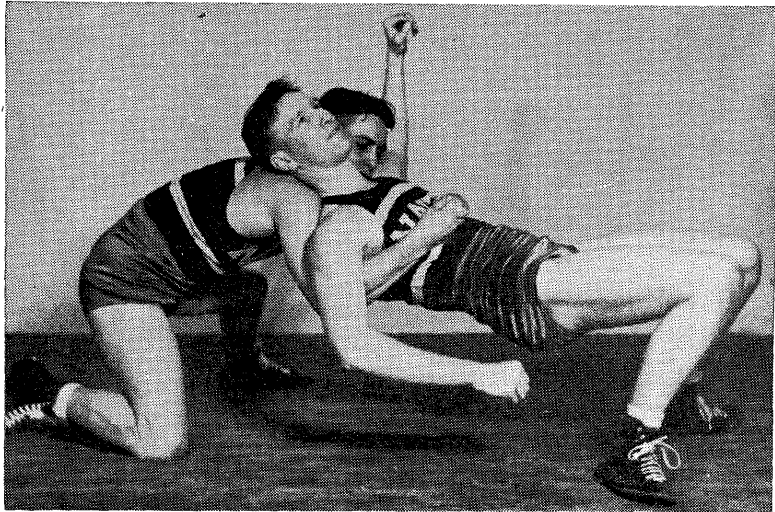
Number 6 seeded man draws for position in opposite half of Quarter Bracket #4.

Number 7 seeded man draws for position in opposite half of Quarter Bracket #3.

Number 8 seeded man draws for position in opposite half of Quarter Bracket #2.



**No. 4—INTERLOCKING OF HANDS AROUND THE BODY—A Technical Violation**  
*Offensive wrestler is not allowed to lock hands, wrists or arms around body while defensive wrestler is supported by parts other than his feet.*



**No. 5—LEGAL USE OF THE HANDS IN WAISTLOCK**

*This shows the legal use of the hands of the top man. The defensive contestant's supporting parts except feet are clearly off the mat.*

**Contestants Eligible for Third Place Matches**

SECTION 6. *a.* Immediately after completion of the first semi-final match in each weight the third place consolation rounds shall start between all contestants defeated by the winner of this semi-final match. (See *b* following.)

After completion of the second semi-final match in this same weight the same plan shall be followed as indicated in the preceding paragraph. The winners of the third place consolation rounds in each of the two half-brackets in each weight class, meet in the final consolation match to determine the third and fourth place winner.

*b.* When only two contestants have been defeated by the winner of any semi-final match the two defeated contestants shall compete and the winner of the match shall meet the corresponding winner from the other half-bracket to decide the third and fourth place awards. When more than two contestants have been defeated by the winner of any semi-final match, preliminary third place matches will be necessary and *should be conducted in accordance with the original first round drawings*; therefore, those eligible for the third place consolations should be matched in the order in which they were defeated by the finalists in this half-bracket. The eligible contestants are designated in Section 6a of this Rule.

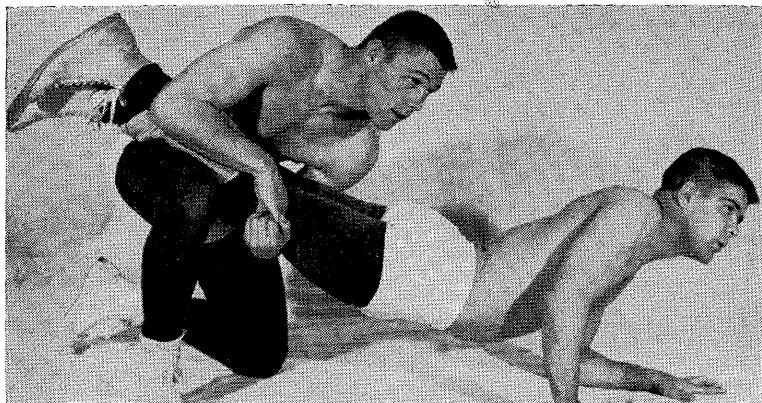
**Example** SECTION 7. Referring to the Graphic Illustration under Section 5, those eligible for the third place rounds in the upper half-bracket 8, 7, 6, 3, we will assume that 8 wins from 7 and then 6 wins from 8 and 6 defeats 3.

In the lower half-bracket three contestants 16, 15 and 13 have been defeated by the finalist 17 and therefore, only two matches are necessary. We will assume 16 defeats 15 and later defeats 13. He meets 6 in the final consolation match in this weight. The winner 16 is awarded third place and the loser 6 fourth place. All third place matches shall be run off prior to the first place finals matches.

SECTION 8. The Wrestling Rules Committee recommends that medals and team trophies be formally presented in a ceremony made as impressive as possible.

## **RULE VII—CONDUCT OF MATCHES**

SECTION 1. All regular matches shall consist of three three-minute periods. The first period will start with both contestants standing opposite each other and on the 10-foot circle. The wrestlers will come forward, shake hands with the right hand, pass each other, turn to the left at the edge of the circle and, when the Referee blows his whistle, begin wrestling. A fall during this or either subsequent period terminates the match. If neither contestant secures a fall in this first period, the Referee shall recess the match and place the wrestlers in the Referee's position (Rule 8, Section 1) with the appropriate contestant in the position of advantage (Rule 7, Section 3). The second three-minute period shall be started immediately by the Referee's whistle. If no fall occurs during this second period, upon its expiration the Referee shall again recess the match, place the contestant who started the second period in the position of advantage underneath and start the third period as before. If no fall occurs during this final period, upon termination of the match the Referee shall award the contest as provided (Rule 8, Section 14 and Rule 7, Section 4). The time in a match is continuous except when the Referee stops and starts a match.



No. 6—INTERLOCKING OF HANDS AROUND LEGS

*This position is a technical violation*

**Intermission** SECTION 2. Each recess between the periods of any match shall be only such time as is required by the Referee to bring the contestants into the proper position for the next period. No rest shall be permitted except for injury. (See Rule 12, Section 1.)

**Choice of Position** SECTION 3. *a. Dual Meets.* Immediately before the contest starts the Referee shall call the captains to the center of the mat and decide by the toss of a coin which team has the choice of position at the start of the second period in each weight class. The winner of a toss may choose the odd or even weight class. A choice of odd or even matches in dual meets is not altered in case of a fall, default or forfeit.

*b. Tournament.* Immediately following the end of the first period the Referee shall determine which wrestler has the choice of position at the start of the second period, by the toss of a coin.

SECTION 4. *Overtimes.* In tournament competition when there is a tie in points the contestants shall wrestle two extra periods of two minutes each (consolation matches, two periods of one minute each) starting from the referee's position as in the second and third periods of the regular match. The choice of position shall be determined by the toss of a coin. There shall be one-minute rest between the regular match and the first overtime period and no rest between the first and second overtime periods. The points and time advantage are not cumulative throughout the match and overtime periods, and only the points and time advantage scored in the overtime period shall be counted in determining the winner. A jury of two judges and the referee shall observe the overtime periods. When there is a tie in points at the end of the overtime periods the jury shall select the winner by ballot without any consultation and the match shall be awarded to the contestant who has shown superior wrestling ability in the overtime periods. The signed ballots of the jury shall be recorded on the score sheet. The criteria for determining superior wrestling ability are attempts to secure falls, take-

downs, reversals, and escapes along with the maintenance of control.

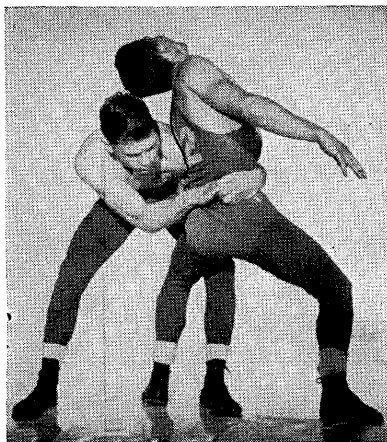
**Consolation Matches** SECTION 5. Consolation matches shall consist of three two-minute periods conducted in the same manner as regular matches in tournaments. Overtime periods in consolation matches shall consist of two one-minute periods.

## RULE VIII—DEFINITIONS

**Referee's Position on the Mat** SECTION 1. *a. Defensive Wrestler.* A stationary position in which the defensive wrestler is on his knees facing in the direction indicated by the design with his hands in the center of the mat. He must keep both knees on the mat and they shall not be spread more than the width of the shoulders. The legs must be parallel, with the toes neither turned out or under in an exaggerated position. The heels of both hands must be on the mat not less than 12 inches in front of the knees; and the elbows shall not touch the mat.

*b. Offensive Wrestler.* The offensive wrestler shall be on his knees at the side of his opponent with his head along the mid line of his opponent's back. The palm of his right (or left) hand shall be placed loosely against the defensive man's navel at the waist line and the palm of his left (or right) hand shall be placed loosely on the back of opponent's left (or right) elbow. Both of his knees shall be on the mat outside of defensive wrestler's near leg. His knee shall not touch the near leg of his opponent and shall be even with or ahead of the defensive man's foot.

**Time Advantage** SECTION 2. The offensive wrestler who has control in an advantage position over his opponent is gaining time-advantage. A timekeeper assigned to each wrestler records his accumulated



### No. 7—LEGAL USE OF HANDS IN BODYLOCK

*This complete bodylock is legal because defensive wrestler is in a standing position. This hold would be a technical violation if defensive wrestler had both knees on mat. (See Rule 10, Section 7.)*

time-advantage throughout the match or a multiple timer may be permitted to record the time-advantage. At the end of the match the Referee subtracts the lesser time advantage from the greater. If the contestant with the greater time-advantage has less than one minute of net time-advantage, no point is awarded. If he has one full minute or more of net time-advantage, he is awarded *one* point by the Referee. No contestant can be awarded more than *one point* for time-advantage in any one match. The contestant with the lesser time-advantage receives no points even though he accumulates several minutes of time in the advantage position.

*Note*—Control is a situation in which a contestant exercises and maintains restraining power over his opponent.

**Position of Advantage** SECTION 3. A position in which a contestant is in control of his opponent. Control is the determining factor. The failure of the offensive wrestler to get his head out from the defensive wrestler's arm does not necessarily prevent the offensive wrestler from having control. The offensive wrestler is entitled to this advantage until such time as his opponent gains a neutral position or a reversal. (See Rule 8, Sections 5, 8, 9 and 10.)

**Take Down** SECTION 4. Whenever a contestant brings his opponent to the mat and gains control while the supporting points of either wrestler are within the wrestling area he has gained a take-down.

*Note*—The supporting points of either wrestler are the parts of the body touching the mat that bear the weight of the wrestler's body other than the parts with which he is holding his opponent. When down on the mat the usual points of support are the knees, the side of the thigh and the buttocks. In a standing position the feet are the main points of support.

**Out-of-Bounds** SECTION 5. Contestants are "out-of-bounds" when any supporting part of either wrestler touches or goes beyond the boundary line with the following exceptions:

a. When a take-down is imminent, wrestling shall continue as long as the supporting points of either wrestler remain within the boundary lines of the wrestling area.

b. When a fall is imminent, wrestling shall continue as long as the head and both shoulders of the defensive wrestler are on the mat proper within the boundary lines.

c. When one wrestler has the advantage position the match shall continue as long as the main supporting parts of either wrestler remain within the wrestling area. If however the referee anticipates a difficult situation at the edge of the mat he may in accordance with Rule 13, Section 11, stop the match and resume the wrestling in the center of the mat.

**Resumption of Wrestling After Out-of-Bounds** SECTION 6. The position to be assumed by the contestants at the resumption of a match shall be neutral or the Referee's position on the mat as determined by the position held upon going out-of-bounds. If neither wrestler has control the match shall be resumed with both wrestlers opposite each other and on the 10-foot circle. If one wrestler has the advantage position he will take the offensive position on top of his opponent in the Referee's position in the center of the mat.



**Stalemate** SECTION 7. When the contestants are interlocked in a position other than a pinning situation in which neither wrestler can improve his position nor tries to improve his position, the Referee shall stop the match and wrestling shall be resumed as for out-of-bounds.

**Neutral Position** SECTION 8. A position in which neither wrestler has control.

**Escape** SECTION 9. An escape occurs when the defensive wrestler gains a neutral position while the supporting points of either wrestler are within the wrestling area.

**Reversal** SECTION 10. A reversal occurs when the defensive wrestler comes from underneath and gains control of his opponent either on the mat or in a rear standing position while the supporting points of either wrestler are within the wrestling area.

**Fall** SECTION 11. Any part of both shoulders or area of both scapula held in contact with the mat for two seconds constitutes a fall. The two-second count (one-thousand-and-one, one-thousand-and-two) shall be a silent count by the Referee and shall start only after the Referee is in such position that he knows positively that a fall is evident, after which the shoulders or scapula area must be held in continuous contact with the mat for two seconds before a fall shall be awarded.

a. A fall shall not be awarded when one or both shoulders or head of the defensive contestant are out-of-bounds. (See Rule 8, Section 5b.)

b. If the defensive wrestler is handicapped by having any portion of his body off the wrestling area, no fall shall be awarded and out-of-bounds shall be declared.

c. When the match is stopped for out-of-bounds in a fall situation, the match shall be resumed in the Referee's position on the mat. (See Rule 8, Sections 1 and 6.)

**Near-Fall** SECTION 12. A near-fall is a situation in which the offensive wrestler *has control of his opponent in a pinning combination* with both shoulders or the scapula area held in contact with the mat for one full second or when one shoulder of the defensive wrestler is touching the mat, and the other shoulder is held within one inch or less of the mat for two full seconds. Three points shall be awarded for these situations.

**Predicament** SECTION 13. A predicament is a situation in which the offensive wrestler *has control of his opponent in a pinning combination* and a fall or near-fall is imminent.

a. When both shoulders of the defensive wrestler are held continuously within approximately four inches of the mat, or less, for one full second or more, a predicament shall be scored. One point shall be awarded for a predicament.

b. When one shoulder of the defensive wrestler is touching the mat, and the other shoulder is held within an angle of 45 degrees or less with the mat, but not sufficiently close to award a near-fall, for one second or more, a predicament shall be scored.

*Note 1*—A near-fall or predicament is ended when the defensive wrestler gets out of the pinning position and into a position in which a fall is no longer imminent.

The Referee must not signal the score for a near-fall or a predicament until the situation is ended. Only one near-fall or one predicament shall be scored in each pinning situation.

regardless of the number of times the offensive wrestler places the defensive wrestler in a near-fall or predicament position during the situation.

*Note 2*—Regardless of the length of time a defensive wrestler may be held in a pinning combination, no predicament or near-fall may be awarded except as provided in Rule 8, Sections 12 and 13 above.

*Note 3*—Only a wrestler with the advantage who has his opponent in a pinning hold may score a near-fall or predicament. Bridgebacks in body scissors or bridgeovers with a wristlock are not considered near-fall or predicament situations although a fall may be scored.

*Note 4*—When the defensive wrestler places himself in a precarious situation during an attempted escape or reversal, a near-fall or predicament shall not be scored unless the offensive wrestler has a pinning hold.

**Decisions** SECTION 14. If no fall has resulted after expiration of the three regular periods of any match as provided in Rule 7, Section 1, the Referee shall award the match to the contestant who has scored the greater number of points as provided by the point system in Rule 9, Section 2. If there is a tie in the number of points scored, the Referee shall declare the match a draw in dual meets. See Rule 7, Section 4 for tournaments.

**Forfeit** SECTION 15. A forfeit is received by a wrestler when his opponent for any reason fails to appear for the match. In order to receive a forfeit, a wrestler must be dressed and appear on the mat.

**Default** SECTION 16. A default is awarded in a match when one of the wrestlers is unable to continue wrestling due to an injury.

## RULE IX—SCORING

**Team Score** SECTION 1. *a. Dual Meet.*

(1) *Fall.* Five points shall be scored toward the team total for each contestant who wins by a fall, default or forfeit.

(2) *Decision.* The decision shall count three points on the team score.

(3) *Draw.* In case of a tie two points shall be scored for each team.

*b. Tournaments.* In tournaments, first place in each weight class shall count 10 points, second place 7 points, third place 4 points and fourth place 2 points. These points shall be awarded as soon as earned. At the conclusion of the championship semifinals, each winner shall receive seven points. At the conclusion of the championship finals, each winner shall receive three additional points, each loser no additional points. At the conclusion of the consolation semifinals, each winner shall receive two points. At the conclusion of the final third place matches, each winner shall receive two additional points, each loser no additional points. One additional point shall be scored for each match won by a fall, default or forfeit throughout the tournament. In addition, one point shall be scored for each match won in both the championship and consolation eliminations except for the final first and third place matches. No points are awarded for a bye in any round.

**Match Point  
Score System**

SECTION 2. In all matches the contestants are awarded points by the Referee in accordance with the following system:

Take-Down (Rule 8, Sec. 4) .....	2 points
Escape (Rule 8, Sec. 9) .....	1 point
Reversal (Rule 8, Sec. 10) .....	2 points
Near-Fall (Rule 8, Sec. 12) .....	3 points
Predicament (Rule 8, Sec. 13) .....	1 point
Time Advantage (Rule 8, Sec. 2) .....	1 point for one full minute or more of net accumulated time in the advantage position. <i>One point is the maximum to be awarded for the match and this point shall be recorded on the final score.</i>

Penalties (See Rule 11 and the Penalty Chart)

*Note*—Method of Recording Score for an Overtime Match.

Example: 3-3, 1-0 (OT)\*

3-3, 1-1, (UD,SD)\*\*

\* OT — Overtime

\*\*UD — Unanimous Decision

SD — Split Decision

**SUMMARY OF SCORING**

<i>Individual Match Points</i>	<i>Dual Meet Points</i>	<i>Tournament Points</i>
Take-Down . 2 pts.	Fall ..... 5 pts.	1st Place ..... 10 pts.
Escape ..... 1 pt.	Forfeit ..... 5 pts.	2nd Place ..... 7 pts.
Reversal ... 2 pts.	Default ..... 5 pts.	3rd Place ..... 4 pts.
Near-Fall .. 3 pts.	Decision ..... 3 pts.	4th Place ..... 2 pts.
Predicament 1 pt.	Draw ..... 2 pts.	Fall ..... 1 pt.
Time Advantage 1 Pt. (maximum for one or more minutes)		Default ..... 1 pt.
		Forfeit ..... 1 pt.
		*Advancement .. 1 pt.

\* See Rule 9, Sec. 1b

**RULE X—INFRACTIONS****Illegal Holds**

SECTION 1. Any hold shall be allowed except the hammer lock above the right angle; the twisting hammer lock; front headlock; the straight head scissors (even though the arm is included); over-scissors; flying mare with the palm up; full (double) nelson; strangle holds; all body slams; toe holds; twisting knee lock; the bending, twisting or forcing of the head or any limb beyond its normal limits of movement; locking the hands in a double arm bar from a neutral position; and any hold used for punishment alone.

*Note 1*—Contestants may grasp all four fingers in an effort to break a hold, but pulling back the thumb, or one, two or three fingers is illegal.

*Note 2*—The term "slam" is interpreted as lifting and bringing an opponent to the mat with unnecessary roughness. This infraction may be committed by a contestant in either the top or bottom position on the mat as well as on a takedown. A contestant who lifts his opponent clear of the mat is responsible for the safe return of that opponent to the mat. A forceful trip is not interpreted as an illegal slam providing the defensive wrestler is not lifted completely off the mat.

*Note 3*—A leg hooked over the top toe of an opponent's straight body scissors is interpreted as an over-scissor and therefore illegal.

*Note 4*—A wrestler applying a legal hold should not be penalized when his opponent turns the legal hold into an illegal hold. The Referee shall cause the hold to be released if there is danger of injury. However, the match need not be stopped unless the Referee finds it necessary to do so in order to correct the situation.

*Note 5*—Whenever possible an illegal hold should be prevented rather than called.

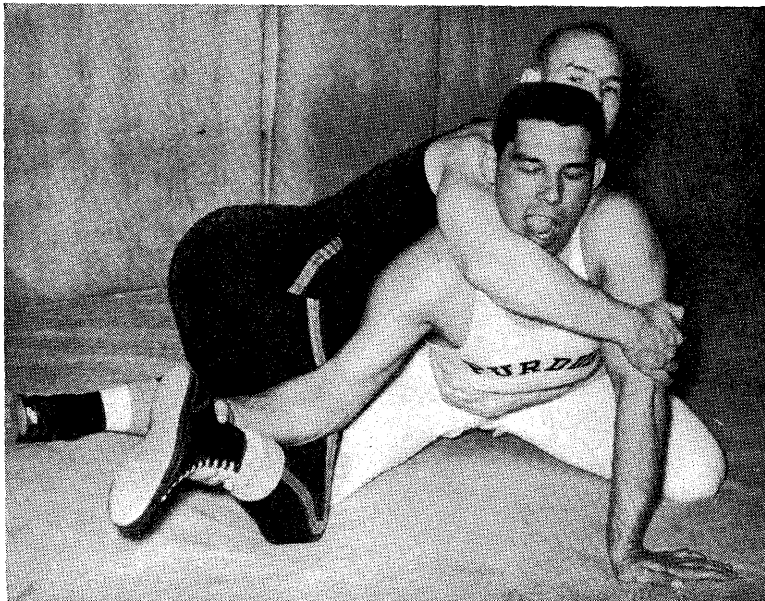
**Unnecessary**

**Roughness**

SECTION 2. Intentional striking, gouging, kicking, hair pulling, butting, elbowing or any intentional act that endangers life or limb shall be grounds for disqualification on first penalty if the referee considers such act as flagrant misconduct. The referee shall follow the penalty chart for the penalties in the case of less flagrant unnecessary roughness. (See Penalty Chart.)

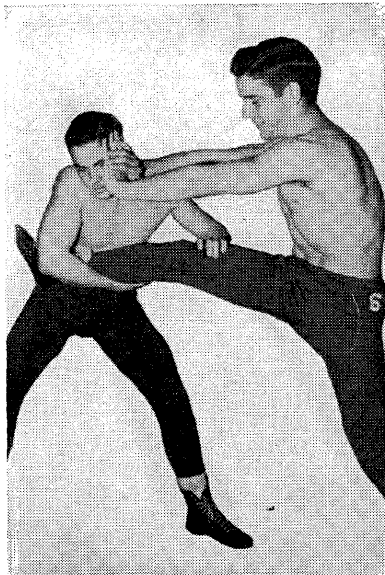
**Foreign Substance on Skin**

SECTION 3. The use of oil or greasy substances which cannot be completely removed shall be grounds for disqualification at the discretion of the Referee. Time out for the removal of such foreign substance shall be cumulative with the time out for injuries throughout the match. The total time out shall not exceed three minutes. (See Rule 12, Section 1.)



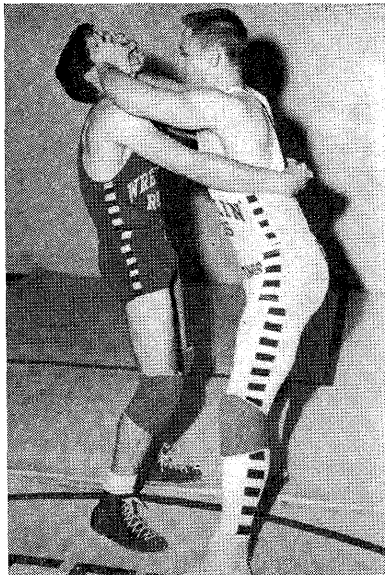
**No. 8—ILLEGAL TWISTING KNEE LOCK**

*This shows the start of a twisting knee lock. If the leg is forced further this will become an illegal hold (Rule 10, Section 1). The Referee should anticipate the danger of injury from this hold and be in a position to block it before it reaches the danger point.*



No. 9—LEGAL BLOCKING ON  
FACE (ON CHIN)

*Blocking on chin or forehead is legal but is not legal over face proper; that is, over mouth, nose or eyes.*



No. 10—ILLEGAL BLOCKING ON  
FACE (ON FACE PROPER)

*This form of blocking is illegal because it is over mouth, nose and eyes, in contrast to position in No. 9.*

**Objectional Pads  
and Braces**

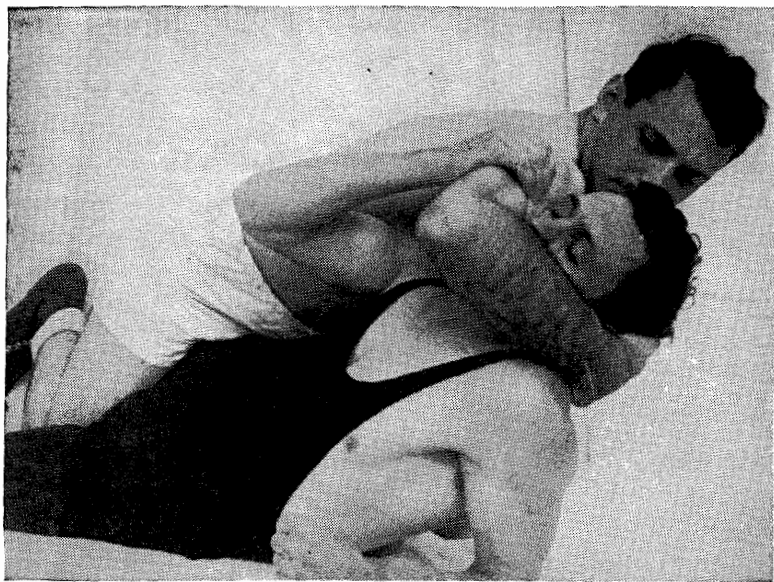
SECTION 4. (See Rule 3, Section 4 and the Penalty Chart.)

**Abusive  
Conduct**

SECTION 5. Conduct of a coach, contestant, or spectator that becomes abusive or interferes with the orderly progress of a match shall be grounds for removal from the premises. The home management shall be responsible for the removal of the violators at the request of the Referee. (See Penalty Chart.)

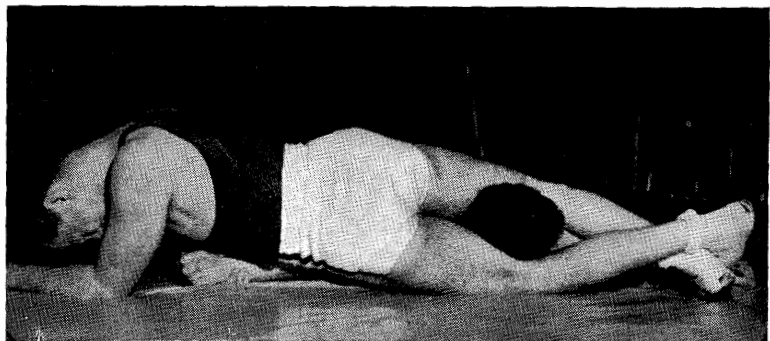
**Potentially  
Dangerous Holds**

SECTION 6. The double wristlock, chicken wing, key lock, overhead double bar lock and other holds may cause injury when used legally, and are potentially dangerous holds. Contestants should know the dangers of these holds and the blocks for them. The Referee should anticipate danger of injury from these holds and be in position to block them before they reach the danger point. Furthermore, all Referees, coaches and contestants should understand that any and all holds used in such a way as to endanger life or limb are illegal and all Referees should verbally caution contestants against forcing a potentially dangerous hold into an illegal position. The double wristlock and chicken wing become illegal when forced into a twisting hammer lock position as in the case of



**No. 11—ILLEGAL FACE HOLD**

*Shows a hold commonly used but which is contrary to both the letter and spirit of amateur wrestling rules. It is frequently used momentarily in order to prevent defensive wrestler from coming out from underneath or to bring defensive wrestler back into position for a fall. Referee should see that offensive wrestler does not secure unfair advantage by means of this illegal action.*



**No. 12—ILLEGAL HEAD-SCISSORS**

*This hold is illegal. All straight scissiors on the head are illegal.*

applying the force parallel instead of perpendicular to the long axis of the body.

It should be understood that no contestant should ever be put in a position where he must forfeit a neutral position, a position of advantage or a fall because of an injury or danger to life or limb, and the Referee should promptly stop any and all holds which in his opinion may so result. If a legitimate hold is forced to such an extent as to endanger a contestant or if it becomes a punishing hold, the Referee shall stop the match and require the hold to be broken. The match shall be resumed in the neutral or Referee's position as determined by the position held at the time the match was stopped.

a. Any holds over the mouth, nose, eye or front of throat shall not be permitted. Pressure from the side of the hand, forearm or wrist is considered a hold and therefore barred when used on the mouth, nose, eyes or front of throat. Forcing such a hold may be considered unnecessary roughness depending on the intent of the act as determined by the Referee and shall be penalized accordingly.

#### Technical Violations

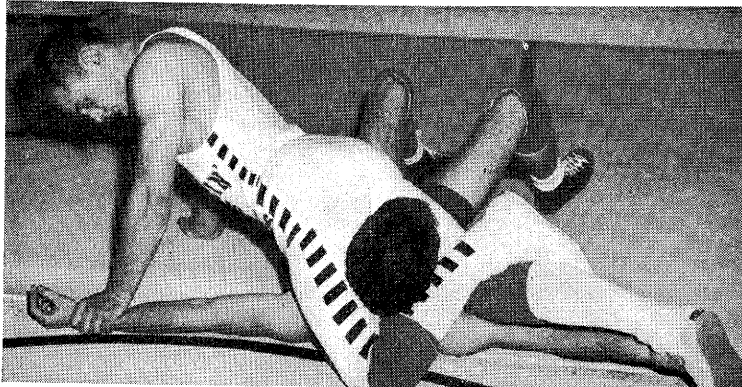
**(See Penalty Chart)** SECTION 7. *a. Interlocking Hands.* Interlocking of fingers, hands or arms, around the body or both legs by the offensive contestant while on the mat is a technical violation. This has reference only to the wrestler in the position of advantage on the mat and does not apply when the defensive man has gained his feet or when the lock is used as a pin hold. Interlocking of fingers, hand or arms, is permitted when the defensive man is standing. The mere touching of the defensive man's hands to the mat is not considered a change in this position unless the hands are used as supporting parts, in which case, the offensive contestant is allowed reaction time to release the lock. It is unsportsmanlike for the defensive contestant to touch his hands to the mat in order to release the offensive wrestler's lock and the Referee shall not call a violation if the lock is held in such cases.

*Note*—The Referee shall not call this violation when the defensive man is in the process of a reversal. The defensive man is allowed to complete the reversal provided he does so in one continuous maneuver. If the defensive man fails to complete the reversal after an opportunity to do so then the Referee will stop the match and award the penalty. (See Penalty Chart.)

b. *Holding Legs.* It is a technical violation for the wrestler in the advantage position on the mat to grasp the defensive wrestler's leg or legs with both hands or arms unless such action is designed to break his adversary down and go into a pinning combination or to prevent an escape or reversal. Repeatedly grasping and holding the leg or legs with both hands or arms merely to break the defensive wrestler down or to keep him under control for the purpose of stalling is a violation under this rule. When the defensive wrestler has gained his feet the wrestler in the advantage position is allowed reaction time to begin his break down when he is holding a leg or legs with both hands or arms.

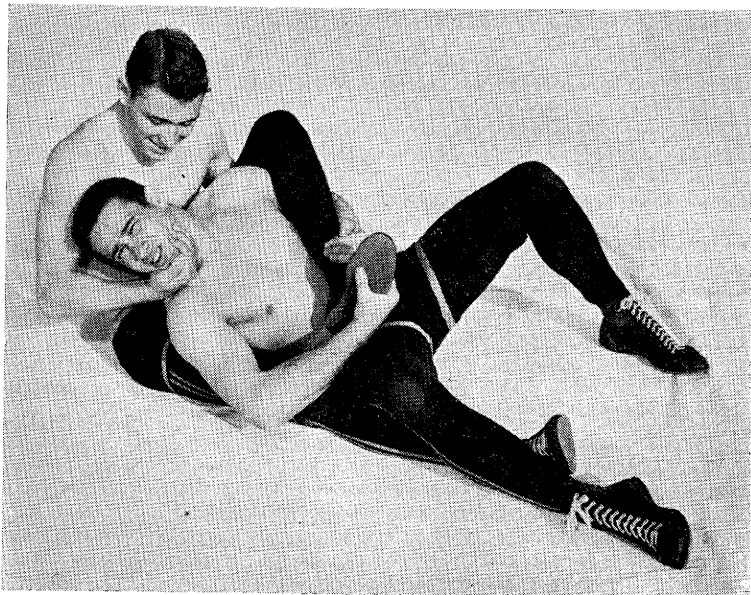
c. *Leaving Mat Without Permission.* It is a technical violation to leave the mat without first receiving permission to do so from the Referee.

d. *Delaying Match.* Delaying the match such as straggling back from out-of-bounds, unnecessary changing and adjusting equipment, repeatedly assuming incorrect referee's position and repeatedly making false starts from the referee's position are technical violations.



**No. 13—LEGAL HEAD-SCISSORS (FIGURE 4 HEAD-SCISSORS)**

*The straight head-scissor is illegal. The figure 4 Head-Scissor is considered legal when taken as shown above, with the hold on either side of the face.*



**No. 14—LEGAL FOOT (INSTEP) HOLD**

*All toeholds, regardless of the degree to which the leg is twisted are illegal under these rules. Any pressure against the knee joint as shown by the above illustration constitutes an illegal hold.*



*e. Intentional Forcing Opponent Off Mat.* Intentional forcing opponent off the mat to prevent a take-down, reversal or an escape is a technical violation. (See Penalty Chart.)

*f. Intentional Going Off Mat.* Intentionally going off the mat to prevent a take-down, reversal or escape is a technical violation. (See Penalty Chart.)

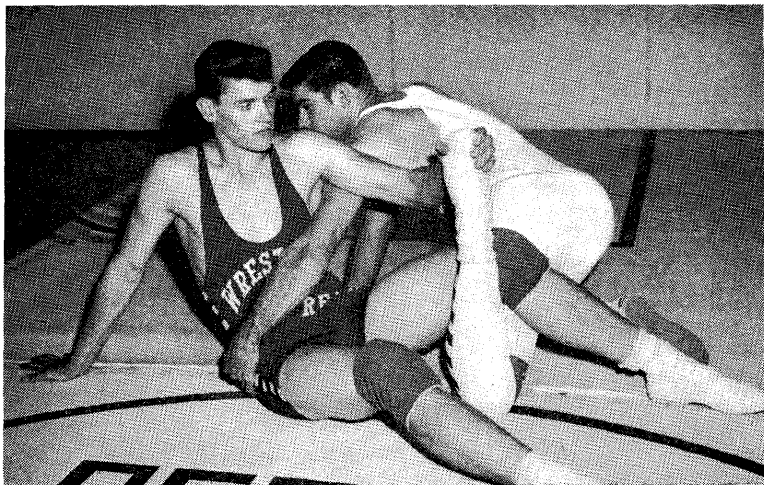
*g. Defensive Wrestler Intentionally Going Off Mat.* It is a technical violation if the defensive wrestler intentionally walks, crawls, rolls or bridges off the mat. No penalty is provided if a near-fall or predicament is awarded during this violation.

*Note*—It is considered a violation if the contestant in a figure-four body scissors intentionally goes off the mat to get the hold released.

*h. Stalling.* It is the responsibility of both contestants to maintain action throughout the match by making an honest attempt to stay in the circle and wrestle aggressively whether in the top, bottom or neutral positions. (See Penalty Chart.)

(1) *Neutral Position.* Each wrestler must make an honest attempt to stay in the circle and secure a take-down regardless of the time or score of the match. A contestant who continually avoids contact with his opponent is stalling. A contestant may leave the circle to maneuver for position provided he continues his attempt to gain an advantage and makes an effort to work back into the circle. Taking a position near the edge of the mat for the purpose of going off the mat, or allowing his opponent to push him off when the opponent makes an effort to go behind, is stalling.

(2) *Advantage Position.* The contestant in the advantage position on the mat shall make an honest attempt to wrestle aggressively. A period of twenty



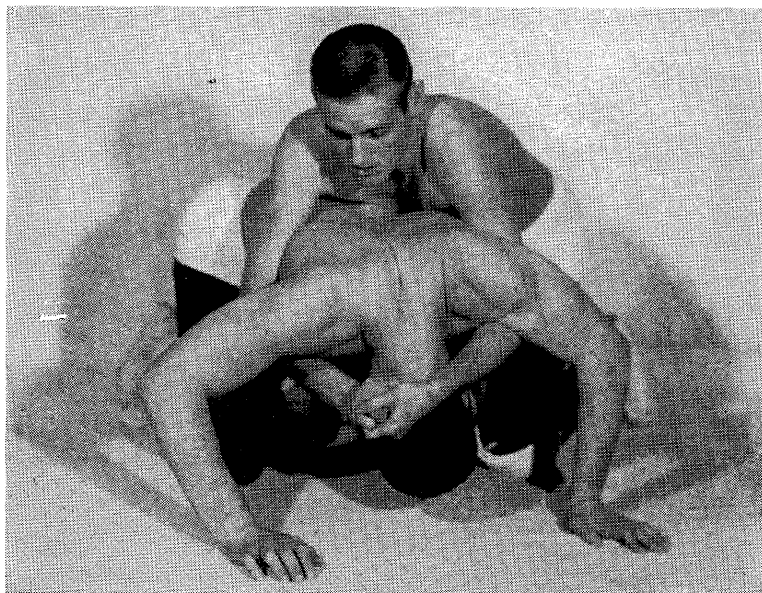
No. 15—ILLEGAL TOEHOOLD (ALSO TWISTING KNEELOCK WHICH IS MORE DANGEROUS THAN TOEHOOLDS)

*All toeholds, regardless of the degree to which the leg is twisted are illegal under these rules. Any pressure against the knee joint as shown by the above illustration constitutes an illegal hold.*



**No. 16—OVER-SCISSORS (AN ILLEGAL HOLD)**

*The over-scissors is barred entirely under these rules because it is only a punishing hold and is of no value unless defensive contestant who uses it is allowed to force the hold, which thereby endangers the ankle and knee of his opponent.*



**No. 17—FULL NELSON—AN ILLEGAL HOLD**

*Most of the difficulty has arisen when the three-quarter is confused with the full nelson. In the full nelson the aggressor places both arms under his opponent's arms and clasps his hands or wrists on the back of his opponent's head. (See Figure No. 24)*

seconds shall be sufficient time for the Referee to decide whether or not a contestant retaining a stalling hold has made an attempt to improve his position. For the second and subsequent penalties a period of fifteen seconds shall be sufficient time to determine the intent to stall.

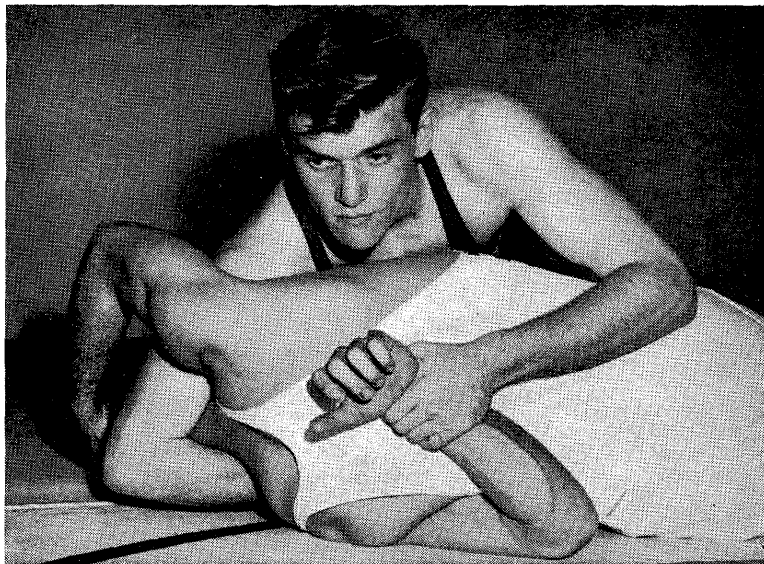
*Note*—Any legal hold is not to be construed as a stalling hold if in the opinion of the Referee the offensive wrestler has a fair chance to pin his opponent and is making a real effort to do so.

(3) *Defensive Position.* Refusing to wrestle aggressively in the defensive position is stalling and shall be penalized as a technical violation. (See Penalty Chart.)

*i. Grasping Clothing, etc.* No grasping of clothing, mat or mat cover by a contestant is permitted and any advantage gained thereby shall be nullified. Grasping clothing to prevent an escape, reversal, takedown or fall, is a technical violation.

## RULE XI—PENALTIES

SECTION 1. The infractions of the rules are penalized in accordance with the penalties as listed on the Penalty Chart. (Page 78.)



No. 18—ILLEGAL HAMMERLOCK (ABOVE RIGHT ANGLE)

*The hammerlock is a legal hold, provided the arm is not bent above the right angle (i.e., provided that the arm is not carried above the small of the back); and provided, further, that the hand is not forced out away from the body, making it a twisting hammerlock. In this illustration the arm is carried distinctly above the right angle and is dangerous.*

## PENALTY CHART

Infractions	First Penalty	Second Penalty	Third Penalty	Fourth Penalty	Rule 10 Sections
Illegal Holds					1
*Technical Violations	1 pt. N.C.	1 pt. N.C.	2 pts. N.C.	Disqualify	7
Unnecessary Roughness					2
Abusive and/or Unsportsmanlike Conduct (See Rule 13, Sec. 16)	Warning	Deduct 1 team point	Remove from Premises		5
Flagrant Misconduct	Disqualify on first penalty				2
Greasy Substance on Skin and/or Objectional Pads and Braces	Disqualify if cannot be removed in allotted time				3 4

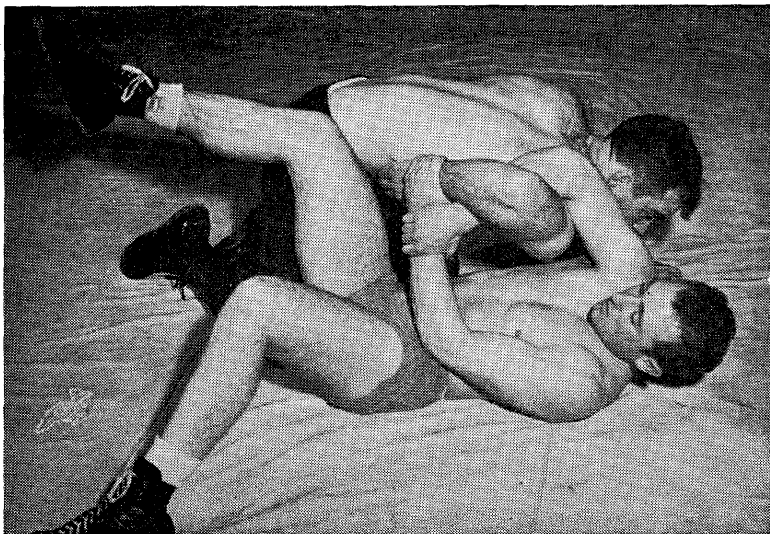
Key: N.C.—no change

### SUMMARY OF TECHNICAL VIOLATIONS (Rule 10, Sec. 7):

- Interlocking Hands (Sec. 7, a)
- Holding Legs (Sec. 7, b)
- Leaving Mat Without Permission (Sec. 7, c)
- Delaying Match (Sec. 7, d)
- Intentional Forcing Opponent Off Mat (Sec. 7, e)
- Intentional Going Off Mat (Sec. 7, f, g)
- Stalling (Sec. 7, n, (1), (2), (3))
- Grasping Clothing, etc. (Sec. 7, i)

\*Note. On technical violations involving stalling a verbal warning shall be given before the first penalty is assessed.

\*\*Note. Disqualification due to a technical violation, illegal holds, or less flagrant unnecessary roughness does not eliminate a contestant from competition for third place in tournaments. Disqualification for any other reason eliminates a contestant from competition for third place in tournaments.



**No. 19—LEGAL DOUBLE WRISTLOCK ON THE MAT**

*The double wristlock on the mat is legal if the direction of the force is perpendicular to the long axis of the body.*

**SECTION 2.** In calling each penalty the Referee shall stop the match, give the hand signal for the points or warning (pages 92 and 93) and announce the penalty so that the contestants, scorers, coaches and spectators are aware of it.

**Sequence of Penalties**

**SECTION 3.** The penalty chart indicates the sequence of penalties and they are cumulative throughout the match including overtime.

**RULE XII—INJURIES AND DEFAULTS**

**SECTION 1.** An injured contestant has a maximum time-out of three minutes which is cumulative throughout the match including the overtime. Nose bleed or any other excessive bleeding shall not be interpreted as an injury and the number and length of time-out periods for such bleeding is left to the discretion of the Referee. There shall be no limit to the number of time-out periods which may be taken in any match, but the total time-out shall not exceed three minutes. If, at the expiration of the time-out, he is able to continue wrestling, the match shall be resumed as if the contestants had gone out-of-bounds.

If a contestant is rendered unconscious he shall not be permitted to continue the match without the approval of a physician. If the injured contestant is unable to continue wrestling, the match shall be awarded in accordance with Sections 2 and 3 of this Rule.

**Accidental Injury** SECTION 2. If a contestant is accidentally injured and is unable to continue the match, his opponent shall be awarded the match by default due to injury.

**Injury from Illegal Action** SECTION 3. If a contestant is so injured by any illegal action that he is unable to continue, the match shall be defaulted to the injured contestant and shall be scored as a fall. In case of an intentional attempt to injure an opponent, the offender shall be disqualified. (See Rule 10, Section 2 and Penalty Chart for "Flagrant Misconduct.")

**Attendants During Time-Out** SECTION 4. No more than two attendants and a physician shall be permitted on the mat with a wrestler during time-out.

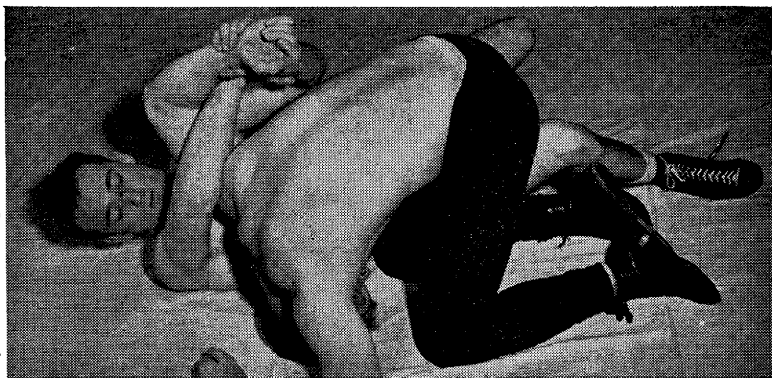
### RULE XIII—OFFICIALS

**Referee's Duties** SECTION 1. On matters of judgement the Referee shall have full control of the meet and his decisions shall be final and without appeal. On matters of a technical nature, the current NCAA Rules shall be the final authority.

SECTION 2. Before the contestants come to the mat the Referee shall:

- a. Inspect contestants for presence of oils or greasy substances, rosin, objectionable pads, improper clothing, finger rings, long finger nails, etc.
- b. Clarify the rules with coaches and contestants.
- c. Advise contestants to report on the circle at the center of the mat opposite each other ready to wrestle.

SECTION 3. The referee is responsible for the seating arrangement at the officials table in accordance with one of the diagrams below:



**No. 20—ILLEGAL DOUBLE WRISTLOCK ON THE MAT**

*This cut shows double wristlock turned into a typical twisting hammerlock that will injure opponent's shoulder if the arms are forced upward, unless opponent turns with the pressure, which often he is unable to do promptly enough to prevent injury to the shoulder.*

**WHEN INDIVIDUAL CLOCKS OR STOP WATCHES ARE USED**

Home Team Assistant Timekeeper	Visiting Team Assistant Timekeeper	Match Timekeeper	Visiting Team Scorer	Home Team Scorer
--------------------------------------	--	---------------------	-------------------------	---------------------

**WHEN MULTIPLE TIMER IS USED**

Timekeeper	Visiting Scorer	Announcer or Home Scorer
------------	-----------------	--------------------------

**SECTION 4.** Instruct the match timekeeper that he is:

- a. In charge of assistant timekeepers, and scorers, and should be constantly checking their activities at all times.
- b. Responsible for keeping the over-all time of the match.
- c. Responsible for recording accumulated time-outs for injury.
- d. Responsible for informing the Referee, only after an imminent situation has passed, whenever there is disagreement by the official scorers and/or timekeepers.
- e. Responsible for assisting the Referee in determining whether a situation occurred before or after the termination of a period.
- f. Responsible for calling the minutes to the Referee, contestants, and spectators in each match. The last minute shall be reported at fifteen second intervals.

*Note*—The Home Institution shall provide each timekeeper with an accumulative time clock for recording the time during the match. The match timekeeper shall be provided with two extra accumulative time clocks for recording time out in case of injury to the contestants. The match timekeeper shall also be provided with a gong, horn, or bell.

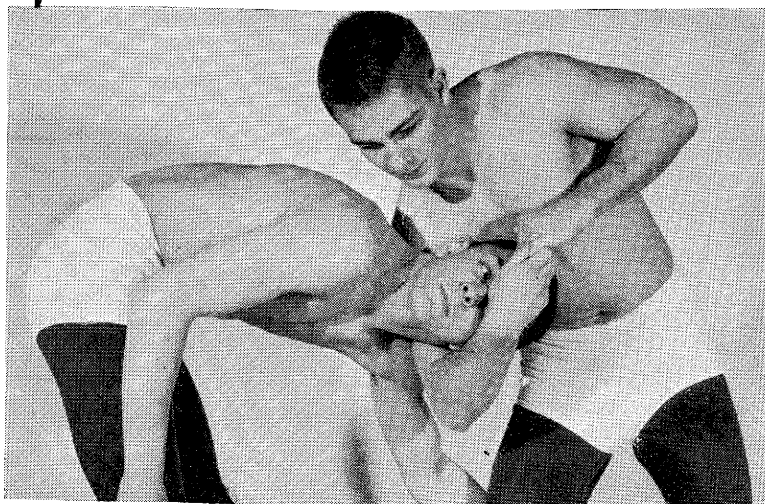
A multiple timer may be used in place of time clocks.

**SECTION 5.** Instruct the assistant timekeepers that they are responsible for:

- a. Recording the accumulative time advantage of the contestants, to whom they have been assigned when indicated by the Referee.
- b. Constantly checking each other's time advantage recording.
- c. Constantly checking the match timekeeper's time recording.
- d. Showing the Referee the stop clock recording of the time advantage each contestant has accumulated at the end of the match.

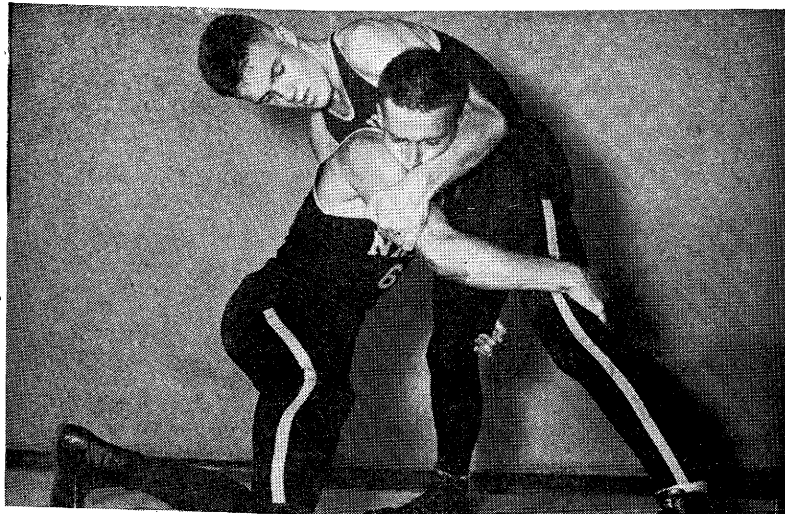
**SECTION 6.** Instruct the scorers that they are responsible for:

- a. Recording which contestant has the position of advantage at the start of the second and third periods.
- b. Recording points scored by both contestants when signaled by the referee.
- c. Constantly checking each other's score reading.
- d. Immediately advising the match timekeeper when they are in disagreement regarding the score.



**No. 21—ILLEGAL FRONT HEAD LOCK**

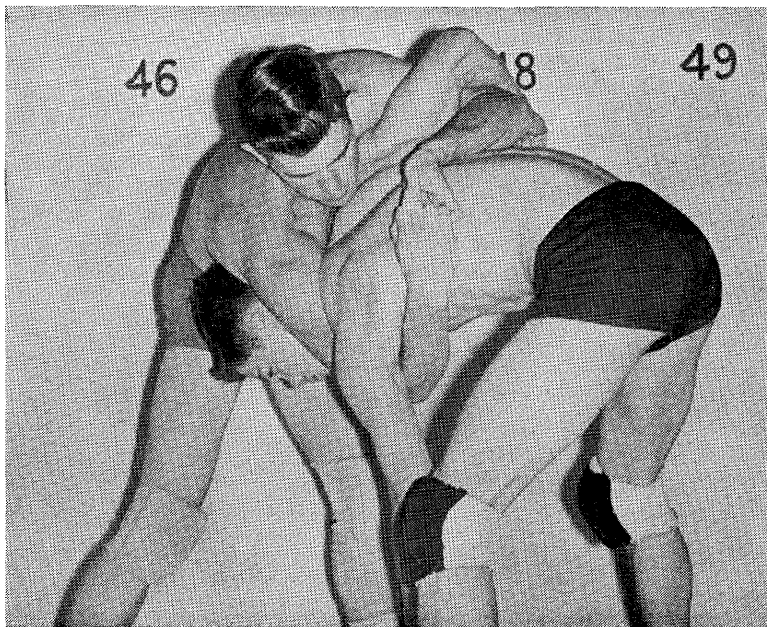
*This cut shows how the front head lock is used to counter a leg pickup. This hold is dangerous and is illegal.*



**No. 22—A LEGAL CROSS FACE**

*It is an effective and legal block for the double leg pickup.*





**No. 23—ILLEGAL DOUBLE ARM BAR**

*Locking hands in a double arm bar from a neutral position.*

**e.** Keeping the score board operator continually advised of the official score during each match.

**f.** Showing the Referee the scorecard at the end of each match.

**SECTION 7.** Before the dual meet starts call the team captains to the center of the mat for the toss of the coin to determine the choice of position at the start of the second period. (Rule 7, Section 3.)

**SECTION 8.** The Referee will use the Wrestling Officials Signals.

**SECTION 9.** The Referee shall notify the timekeepers as follows:

**a.** When the match is started or stopped for any reason.

**b.** When time advantage begins or ends for a contestant.

**c.** Whenever time is involved in any situation occurring in the match.

**SECTION 10.** The Referee shall notify the scorer, when warnings or points are awarded to either contestant. (See Signals for Referees.)

**SECTION 11.** The Referee should anticipate difficult positions on the edge of the mat and prevent them by stopping the match, and resume wrestling at the center of the mat, as in the case of an off-mat decision.

**SECTION 12.** The Referee shall be firm in enforcing the letter and spirit of the rules and penalize consistently any repeated infractions. He must enforce vigorously and promptly the penalties for the infractions as provided in Rules 10 and 11. On each penalty the referee shall stop the match and announce the penalty in the prescribed manner so that the contestants, scorers, coaches and spectators are aware of it. (See Signals for Referees.)

**SECTION 13.** The Referee shall caution the user of a potentially dangerous or illegal hold in order to prevent possible injury. Such holds should be stopped by the Referee, if possible, before reaching the dangerous stage.

**SECTION 14.** The Referee should not place his hands under the shoulders of a contestant unless absolutely necessary to determine a fall.

**SECTION 15.** The Referee should meet promptly, in a spirit of good sportsmanship, any situation developing unexpectedly.

**SECTION 16.** If the conduct of a coach, contestant, or a spectator interferes with the orderly progress of the match, the home management shall be responsible, at the request of the Referee, for the removal of the offender from the premises. (See Penalty Chart.)

**SECTION 17.** At the end of a match the referee shall order the contestants to shake hands and raise the hand of the winner. If there is a doubt as to the winner the Referee shall order the contestants to stay on the mat while he checks the time advantage and the scorer's records to decide the winner. The time advantage, if any, shall be recorded on the score board and the referee shall declare the winner in accordance with the instructions in the first sentence of this section. In dual meets, if the match is a draw the referee will raise one hand of each wrestler.

*Note 1*—If in the opinion of the Referee there is an error in the recordings of the timekeepers and/or scorers, the Referee shall correct the error and render his decision accordingly.

*Note 2*—In overtime periods if the points are even the referee and two judges shall determine the winner by ballot. (See Rule 7, Section 4.)

## **RULE XIV—NOTIFICATION AND AGREEMENT OF MEETS**

**Equal Rights for Visiting Teams** **SECTION 1.** All modifications of rules of competition, "ground rules," etc., proposed by the home manager, must be submitted to the manager of the visiting team, or teams, a sufficient length of time before date of meet for agreement to be reached on same, and no such action is binding unless approved by the visiting team or teams.

**SECTION 2.** In dual meets the selection of a Referee and the maximum weighing-in time shall be mutually agreed upon at least ten days prior to date of meet.

*Note*—In case the Coaches concerned are unable to agree on a shorter maximum weighing-in time than the five hours specified as the maximum in these rules, it is understood that the maximum amount of time as specified in the rules shall hold.

**SECTION 3.** The home management shall notify visiting teams at least ten days prior to date of meet the exact time and place of the meet, the name of the referee, and if shirts will be required.

# Supplementary Modifications for Interscholastic Wrestling

The NCAA Rules shall apply with the following exceptions:

1. **Eligibility.** Contestants shall be eligible under the rules of the High School Athletic Association of the State in which their school is located.

2. **Weight Classification.** Competition shall be divided into weight classes as follows:

103 lbs.	127 lbs.	145 lbs.	165 lbs.
112 lb.	133 lbs.	154 lbs.	Unlimited.
120 lbs.	138 lbs.		

The 95 and/or 180-lb. classes may be officially included in the weight classification provided either or both are adopted by individual state association. Interstate dual meets shall be conducted in the original ten weights.

Beginning January 1st and continuing until February 1st, two additional pounds will be allowed in each weight class. Beginning February 1st and continuing for the remainder of the season, one additional pound shall be allowed in each weight class. This will make a net increase of three pounds beginning the 1st of February.

**Weight Control Recommendation.** The Rules Committee recommends that the family physician and/or the school physician shall determine the lowest weight class a boy may wrestle in prior to the first meet in which that boy competes. A certificate listing the lowest weight class in which the boy may compete shall be dated and filed in the principal's office with a duplicate sent to the State Association Office.

### 3. Weighing In of Contestants.

A. **DUAL MEETS.** Contestants may weigh in a maximum of one hour and a minimum of one half-hour before time the meet is scheduled to begin. (By mutual consent of the competing schools the college regulations may be followed.)

B. **TOURNAMENTS.** Each day of the tournament, contestants may weigh in a maximum of five hours and a minimum of one hour before the meet is to begin, with one pound allowance to be given each day over the weight limit of the previous day.

*Note.* Changes in weighing in time may be made by the individual state associations

### 4. Length of Matches.

A. **DUAL MEETS.** These matches shall be six minutes in length divided into three periods of two minutes. No rest is allowed. These matches shall be conducted in the same manner as set forth in Rule 7 and Rule 8, Section 14.

B. **TOURNAMENT.** These matches shall consist of three periods of two minutes each, conducted in the same manner as third-place matches under

Rule 7, Sec. 5. If a match results in a tie, it shall be decided in accordance with Rule 7, Sec. 4, except the overtime shall consist of *two one-minute periods*.

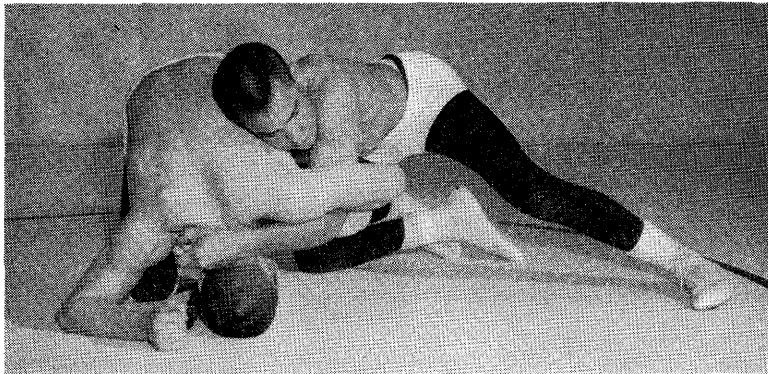
C. No contestant shall be required to wrestle two matches in any tournament with less than a one (1) hour rest between such matches.

5. **Illegal Holds.** In addition to the illegal holds barred in Rule 10, all headlocks without the arm or leg included are illegal.

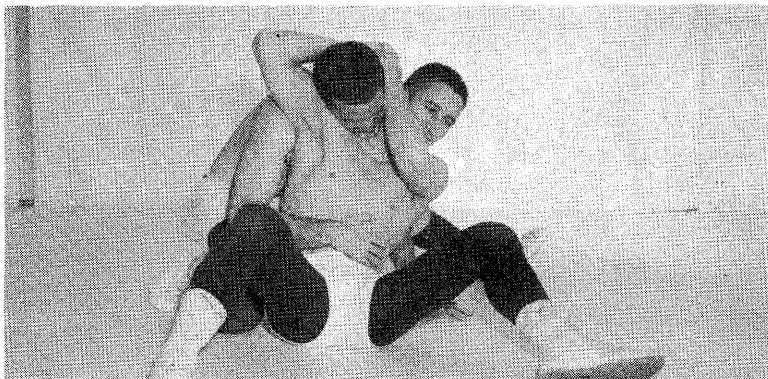
*Note 1*—The full three-quarter nelson is not to be interpreted as a headlock.

*Note 2*—Pulling the head over the shoulder with hands locked or overlapped is not to be interpreted as a headlock.

#### A. LEGAL HEAD HOLDS.



No. 24—FULL  $\frac{3}{4}$  NELSON, A LEGAL HOLD



No. 25—A LEGAL HOLD

*Pulling the head over the shoulder with hands locked or overlapped.*

**B. ILLEGAL HEADLOCK.** An illegal headlock shall be interpreted as locking or overlapping the hands or arms around an opponent's head or neck without including the opponent's arm or leg in the hold.



No. 26—ILLEGAL HEAD  
LOCK

*Locking the arm around the  
head.*

No. 27—LEGAL HEAD  
LOCK

*Opponent's arm is included  
in the lock.*

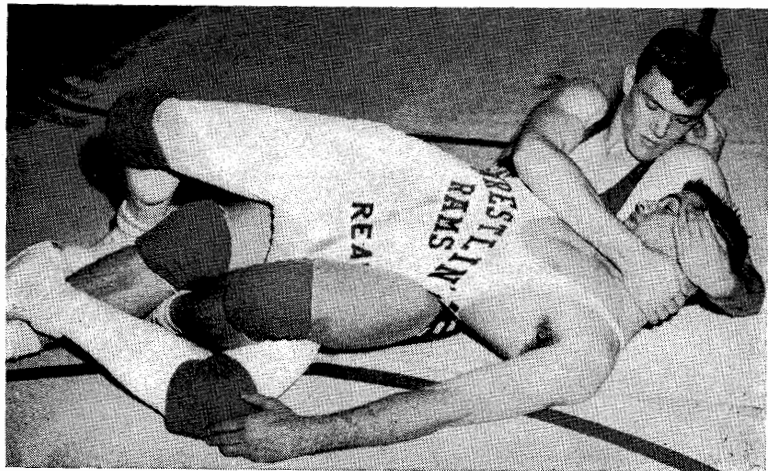


C. **ILLEGAL GUILLOTINE.** If the wrestler locks or overlaps his hands or arms around his opponent's head or neck in securing this hold and the opponent's arm is not included, this is an illegal hold.



**No. 28—ILLEGAL GUILLOTINE**

*Arm is locked around opponent's head or neck.*



**No. 29—LEGAL GUILLOTINE**

*Hands are not locked or overlapped around head or neck.*

# Referees' Signals

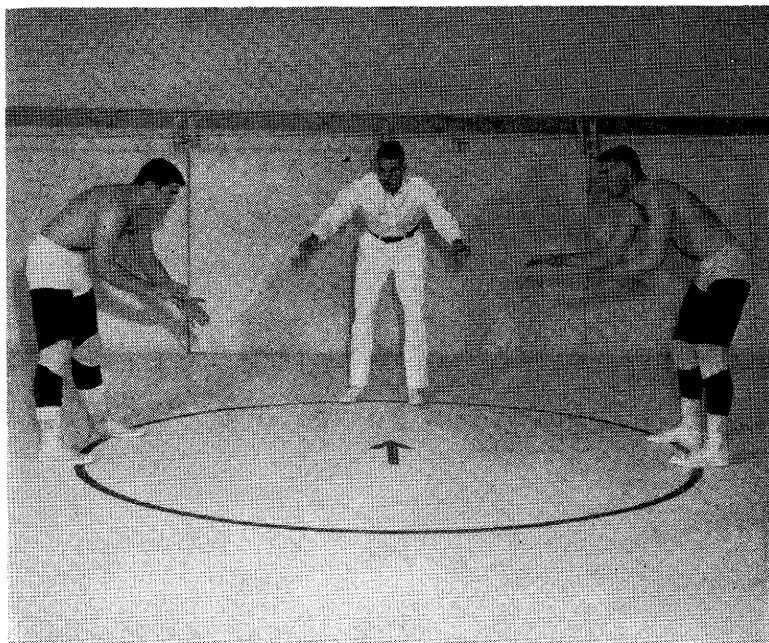
The signals illustrated on the following pages are standard for wrestling referees throughout the nation. It is the duty of every referee to know these signals in order to give them instantly and clearly so that the wrestlers, timers, scorers and spectators are aware of what is taking place during the progress of the match.

SECTION 1. Referee's attire for the National Collegiate Wrestling Championships:

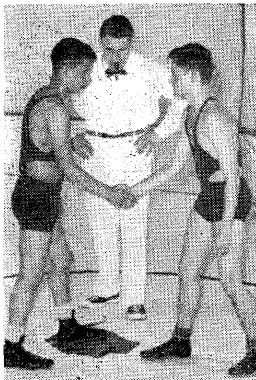
- a. White long sleeved dress shirt.
  - b. White full length trousers.
  - c. White sox and black gym shoes.
  - d. Black belt.
- Other accessories—silver dollar and whistle.

**The Use of  
the Whistle**

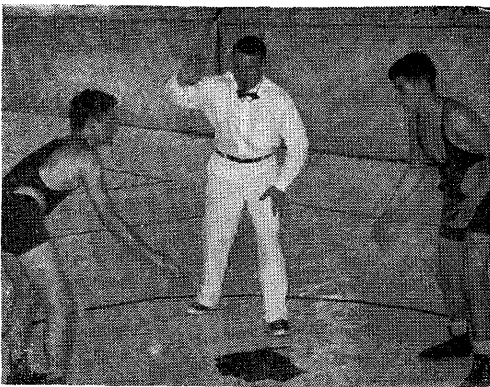
SECTION 2. The whistle should be held ready for immediate use at all times during the match.



*Fig. 1. DESIGNATING THE POSITIONS OF THE WRESTLERS BEFORE THE START OF THE MATCH. As the wrestlers come onto the mat the referee points to the places they are to take on the circle. He next points one hand toward the timers and scorers to verify their readiness.*



**Fig. 2. (top left) SHAKING HANDS AND PASSING BY.** After the officials indicate they are ready at the table, the referee directs the wrestlers to shake hands, pass by and be ready to wrestle when the whistle blows. The referee motions for the wrestlers to shake hands and pass by crossing his arms in front of his body.

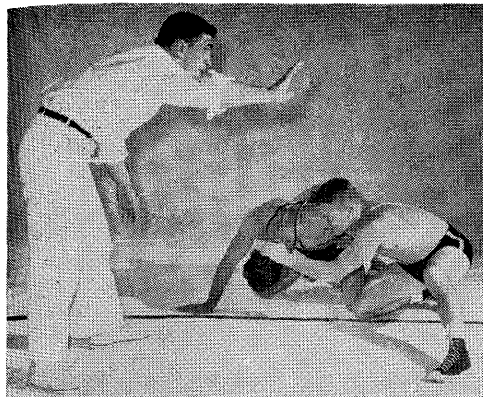


**Fig. 3. (top right) STARTING THE MATCH OR RESUMING THE MATCH IN A NEUTRAL POSITION.** After the wrestlers pass by they turn and face each other. The referee raises his hand forward between the two wrestlers. After a momentary pause to make certain the wrestlers are ready he blows his whistle and simultaneously drops his hand as a signal for the wrestlers to go into action.

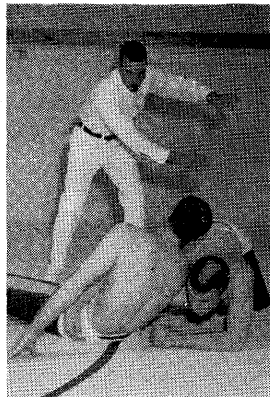


**Fig. 4. (bottom left) RESUMING THE MATCH IN THE REFEREE'S POSITION ON THE MAT.** The Referee should face the officials' table and kneel on one knee at a distance of 8 to 10 ft. in front of the wrestlers and a little to the side on which the top wrestler stations himself. The referee may give a preparatory command such as "get set" or "ready." When the wrestlers are in proper positions (Rule 8, Sec. 1) and after a momentary pause the referee blows his whistle and drops his hand to start the action. Note - Some wrestlers watch the referee's hand to get a fast start. It is usually better in such cases to blow the whistle a moment before dropping the hand. The whistle starts the action. The hand signal is for the timer; in case they do not hear the whistle.

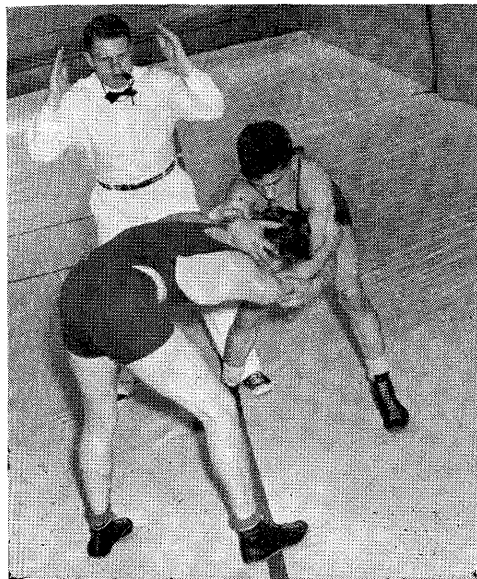




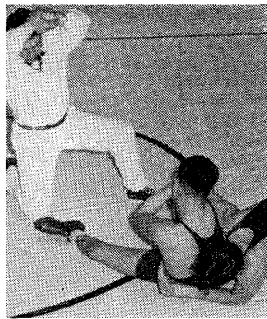
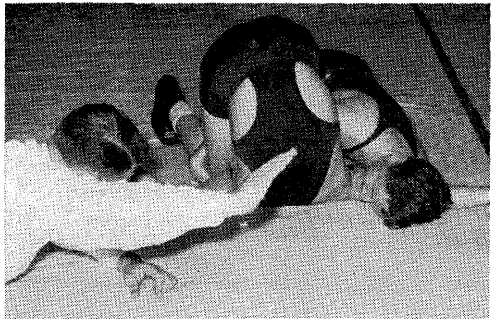
*Fig. 5. (top left) STOPPING THE MATCH. The referee blows his whistle and raises his hand to stop the match. The arm and hand are extended with the palm of the hand directed toward the officials' table.*



*Fig. 6. (top right) STOPPING THE MATCH FOR OUT-OF-BOUNDS. When the contestants are out-of-bounds (Rule 8, Sec. 5) the referee stops the match and extends both arms horizontal to the same side toward the out-of-bounds.*

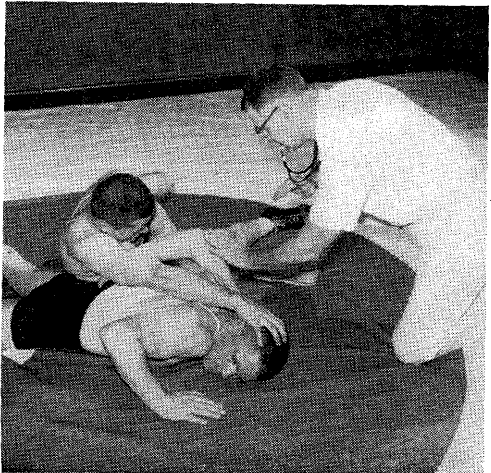


*Fig. 7. (bottom left) DECLARING A NEUTRAL POSITION STANDING AFTER OUT-OF-BOUNDS. When the contestants are out-of-bounds (Rule 8, Sec 5 and 5a) and neither is in an advantage position, the referee stops the match as in Fig. 5 and signals a Neutral position. The upper arms are front horizontal, both forearms are vertical and the hands are extended upward. The referee places himself in the most advantageous position to determine the out-of-bounds and stops the match immediately when the out-of-bounds occurs.*



**Fig. 13. (top left) CALLING A FALL.** When the fall (Rule 8, Sec. 11) is imminent the referee raises one hand about 10 inches. As soon as the fall is completed he quickly strikes the mat with the palm and verbally announces "Fall." The referee is not to put his hands under the back of the defensive wrestler unless his view of the shoulders is blocked by one or both contestants and it is absolutely necessary for him to feel the back on the mat in order to call the fall (Rule 13, Sec. 14)

**Fig. 14. (top right) INTERLOCKING HANDS, (Rule 10, Sec. 7a) OR GRASPING CLOTHING, (Rule 10, Sec. 7i) DURING AN ESCAPE MANEUVER.** When the bottom contestant is in the process of an escape or reversal and the contestant on top locks his hands or grasps the clothing to prevent the maneuver, the referee indicates the violation by grasping the wrist of one hand with his other hand and holding it over his head. This signal stops the advantage time for the top contestant, and indicates the violation has occurred but the referee is allowing the bottom contestant an opportunity to complete the action providing he does so in one continuous maneuver. If the maneuver is successful (bottom contestant gains neutral or top position) the referee signals the points and the match continues with no interruption. If the bottom contestant fails to complete the maneuver the referee stops the match and awards the penalty. (See Penalty Chart)

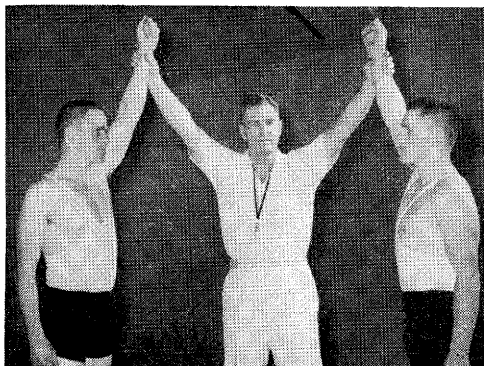


**Fig. 15. (bottom left) PREVENTING AN ILLEGAL OR POTENTIALLY DANGEROUS HOLD. (Rule 16, Sec. 6 & Rule 13, Sec. 13)** The referee anticipates a potentially dangerous hold and gets in position to block it before it becomes dangerous. He may also verbally caution the contestant against forcing a potentially dangerous hold into an illegal hold.



*Fig. 16. (top left) CALLING TIME OUT. The match is stopped as in Figure 5. If there is to be a delay in resuming the match, the referee will indicate "time-out" by extending one hand in a vertical position at right angles to his chest with the ends of the fingers touching the palm of the other hand which is extended in a horizontal position in front of the chest. The referee announces to the scorers the reason for the time out and to whom it is charged.*

*Fig. 17. (center right) DECLARING THE WINNER. (Rule 13, Sec. 17) At the end of the match the referee orders the wrestlers to shake hands and raises the hand of the winner.*

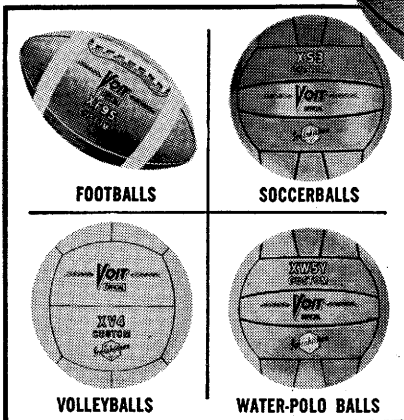
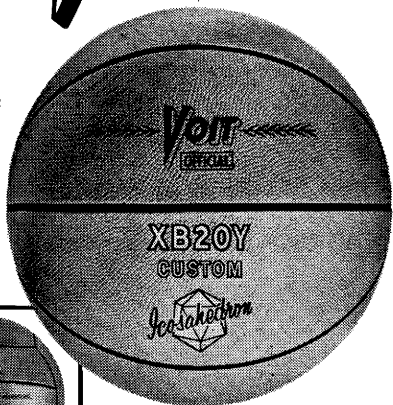


*Fig. 18. (bottom left) DECLARING A DRAW. In case of a tie score at the end of the match in dual meets the referee will raise a hand of each of the contestants after they shake hands.*



don't just hope for  
**VOIT QUALITY**  
 buy **VOIT**<sup>®</sup>  
 and be sure!

Voit originated rubber-covered athletic equipment—was the first company to make official, championship, rubber-covered footballs and basketballs. Voit's endurance, performance and playability have been proved over 20 years school use. Buy Voit to be sure. It costs less in the long run.



**BASKETBALLS**

... Voit Top Grade Athletic Equipment is recognized by the rules books for official play.

**VOIT**<sup>®</sup> ←

NEW YORK 11 • CHICAGO 11 • LOS ANGELES 11

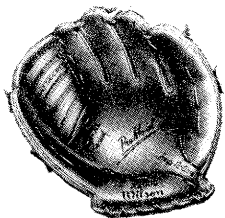
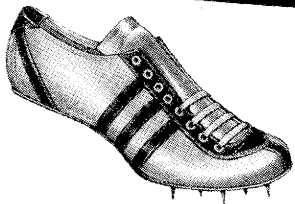
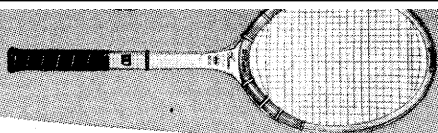


*America's Finest Athletic Equipment*

**USED IN OVER FIFTY MILLION GAMES A YEAR**—3 to 6 times longer wear. Weatherproof and washable. Official standards for life.

**QUALITY LINES IN EVERY PRICE RANGE**—For championship play. For rugged practice and school play. For playground and backyard. For longest wear at lowest possible price.

**SPECIFY VOIT—BECAUSE THERE IS NO "OR EQUAL" TO VOIT**



# WIN WITH

Wilson provides the world's finest equipment for Football, Basketball, Baseball, Golf, Tennis—and other sports; developed and designed in conjunction with the famed Wilson Advisory Staff.

WILSON SPORTING GOODS CO., CHICAGO

# SPALDING

*sets the pace in sports*

To insure latest design, finest materials, superb craftsmanship, always specify Spalding — Official With America! Pacing the entire equipment field are these top-flite products: the great No. 100 "Last-Bilt" basketball, the revolutionary Cushion-Control basketballs; the Bowl Game favorite J5-V football, the new J6-V Cushion Control football; Pancho Gonzales tennis rackets and major league baseballs *made only* by Spalding.